



Tahir Group Of Industries

General Surgical Instruments



Welcome To TGIND

KGIND is Adding to it's Tradition Of Providing Quality Surgical Instruments



TG-REF:101

Size: 14cm
17cm
22cm

**Mayo Scissors
Curved**



TG-REF:102

Size: 11cm
13cm
15cm
17cm
20cm

**Dressing
Scissors**



TG-REF:103

Size: 9cm
11cm
13cm
16cm
19cm
20cm

**Surgical Bandage
Scissors**



TG-REF:104

Size: 14cm
18cm

**Spencer Stitch
Scissors**



TG-REF:105

Size: 15.5cm

**Schumacher Umbilical Cord
Scissors**



TG-REF:106

Size: 20cm

**Waldmann Episiotomy
Scissors**



TAHIR GROUP OF INDUSTRIES



+92-300-6669737



TAHIR GROUP OF INDUSTRIES



TGIND.COM



TAHIR GROUP OF INDUSTRIES



tgindsale@gmail.com

Surgical Scissors

TGIND
Instruments

TG-REF:107
Size: 10cm



Umbilical Cord Scissors

TG-REF:108
Size: 16cm



Umbilical Busch Scissors

TG-REF:109
Size: 20cm



Dammschere Episiotomy Scissors

TG-REF:110
Size: 20cm



Sims Uterine Scissors
Curved

TG-REF:111
Size: 19.5cm



Wertheim Scissors

TG-REF:112
Size: 18cm



Doyen Scissors
Straight + Curved



TAHIR GROUP OF INDUSTRIES



+92-300-6669737



TAHIR GROUP OF INDUSTRIES



TGIND.COM



TAHIR GROUP OF INDUSTRIES



tgindsale@gmail.com

2



TG-REF:113
Size: 10cm

Umbilical Cord Scissors



TG-REF:114
Size: 16cm

Umbilical Busch Scissors



TG-REF:115
Size: 20cm

Dammschere Episiotomy Scissors



TG-REF:116
Size: 20cm

Sims Uterine Scissors
Curved



TG-REF:117
Size: 19.5cm

Wertheim Scissors



TG-REF:118
Size: 18cm

Doyen Scissors
Straight + Curved





TG-REF:119
Size: 14cm
17cm
22cm

**Mayo Scissors
Straight TC**



TG-REF:120
Size: 11cm
13cm
15cm
17cm
20cm

**TC Iris
Scissors Curved**



TG-REF:121
Size: 9cm
11cm
13cm
16cm
19cm
20cm

**Surgical Bandage
Scissors**



TG-REF:122
Size: 14cm
18cm

**Spencer Stitch
Scissors**



TG-REF:123
Size: 15.5cm

**Schumacher Umbilical Cord
Scissors**



TG-REF:124
Size: 20cm

**Waldmann Episiotomy
Scissors**





TG-REF:125
Size: 16cm

Kelly Scissors



TG-REF:126
Size: 20cm

**Solz Gold Tip Scissor
TC**



TG-REF:127
Size: 20cm

**Foman Angular Scissors
Serrated Blades**



TG-REF:128
Size: 16cm

**Metzenbaum Scissors
Straight**



TG-REF:129
Size: 16cm

**Metzenbaum Scissors
Curved**



TG-REF:130
Size: 13.5cm

**Joseph Plastic
Scissors**



TG-REF:131
Size: 12cm



Neumann Scissors

TG-REF:132
Size: 11cm



**Noyes Scissor
Straight**

TG-REF:133
Size: 11cm



**Noyes Scissors
Curved**

Tips Type

- Fine Blade
- Fine Sharp w/one Probe Point Blade
- Delicate Blade
- Ultra Delicate Blade

TG-REF:134
Size: 14cm



All Micro Gum Scissors

	25°	45°	60°	90°	125°	Straight	Curved on Flat
Fine Blade 1/1							
Fine Blade, with One Probe Pointed Blade 1/1							
Delicate Blade 1/1							



TAHIR GROUP OF INDUSTRIES



+92-300-6669737



TAHIR GROUP OF INDUSTRIES



TGIND.COM



TAHIR GROUP OF INDUSTRIES



tgindsale@gmail.com

TG-REF:135
Size: 12cm



**Castroviejo Scissors
Straight**

TG-REF:136
Size: 11cm



**Castroviejo Scissors
Curved**

TG-REF:137
Size: 14cm
18cm



**Castroviejo Scissors
Curved TC**

TG-REF:138
Size: 14cm
18cm



**Castroviejo Scissors
Straight TC**

All Micro Gum Scissors

Tips Type

- Fine Blade
- Fine Sharp w/one Probe Point Blade
- Delicate Blade
- Ultra Delicate Blade

TG-REF:139
Size: 14cm
18cm



**Castroviejo Scissors
Angular TC**

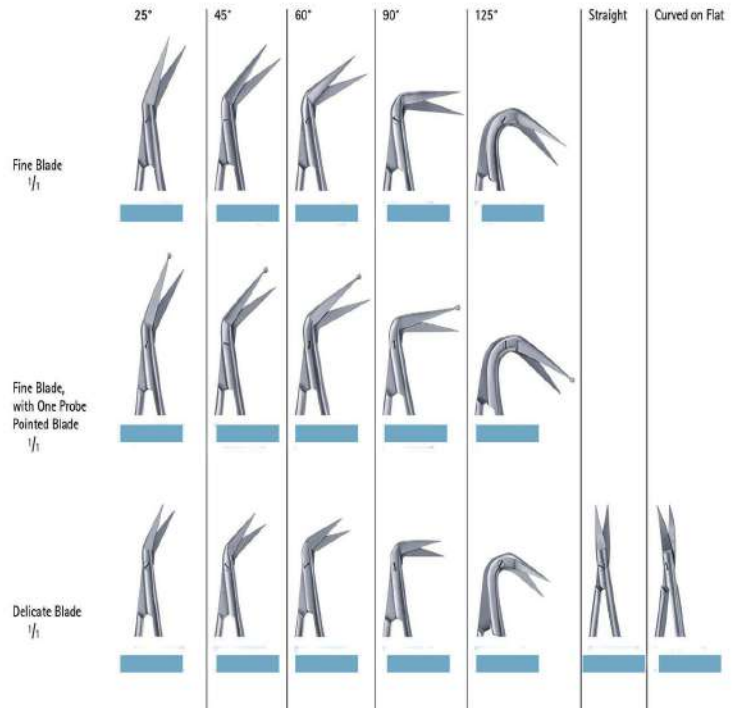



TG-REF:140
Size: 18cm
14cm

TG-REF:141
Size: 14cm
18cm

TG-REF:142
Size: 14cm
18cm

TG-REF:143
Size: 14cm
18cm

**Castroviejo Forceps
Straight**

**Castroviejo Forceps
Curved**

**Castroviejo Forceps
Curved TC**

**Castroviejo Forceps
Straight TC**



TG-REF:144
Size: 14cm
18cm

TG-REF:145
Size: 14cm
18cm

TG-REF:146
Size: 14cm
18cm

TG-REF:147
Size: 14cm
18cm

**Castroviejo Forceps
Straight TC**

**Castroviejo Forceps
Curved TC**

**Castroviejo Forceps
Curved TC**

**Castroviejo Forceps
Anlged TC**

Wire Twisters

TG-REF:A-140
Size: 15.5cm



Wire Twisting
Forceps TC

TG-REF:A-141
Size: 18cm



Wire Twisting
Forceps TC

TG-REF:A-142
Size: 15.5cm
18cm



Wire Twisting
Forceps TC

TG-REF:A-143
Size: 15.5cm



Crowin Combi
Wire Twisting
Forceps

TG-REF:A-144
Size: 15.5cm



Wire Twisting
Forceps TC

TG-REF:A-145
Size: 16cm



Wire Twisting
Forceps TC

TG-REF:A-146
Size: 19cm



Wire Twisting
Forceps TC
Heavy Pattern

The Corwin-Hegar automatic Wire Twister is a special automatic twisting Instrument. In combination with a cerclage wire it can be used for fixation of fractures or temporal fixation. The Automatic Wire Twisters are available in different lengths and with various tungsten carbide inserts.

TG-REF:A-147
Size: 15cm



Crowin-Hegar
Auto Wire
Twisting Forceps
TC

Hemostatic Forceps

TGIND
Instruments



TG-REF:B-140
Size: 12.5cm

Mosquito Kocher Forceps



TG-REF:B-142
Size: 12.5cm

Mosquito Forceps



TG-REF:B-144
Size: 14cm
18cm

Pean Rochester Forceps



TG-REF:B-147
Size: 14cm
18cm

Kelly Locking Forceps

Microsurgery Tweezers

TGIND
Instruments

TG-REF:148
Size: 15cm
18cm



**Micro Ring Forceps
Dusted Tip**

TG-REF:149
Size: 15cm
18cm



**Micro Forceps
Dusted Tip Curved**

TG-REF:150
Size: 15cm
18cm



**Micro Forceps
Dusted Straight**

TG-REF:151
Size: 15cm
18cm



**Micro Ring Forceps
Dusted Tip**

TG-REF:152
Size: 15cm
18cm



**Micro Forceps
Straight TC**

TG-REF:153
Size: 15cm
18cm



**Debaquey Forceps
Curved TC**

TG-REF:154
Size: 15cm
18cm



**Converse Green
Eye Forceps**

TG-REF:155
Size: 15cm
18cm



**Steven Toothed
Dressing Forceps**



TAHIR GROUP OF INDUSTRIES



+92-300-6669737



TAHIR GROUP OF INDUSTRIES



TGIND.COM



TAHIR GROUP OF INDUSTRIES



tgindsale@gmail.com

Microsurgery Tweezers

TGIND
Instruments



TG-REF:156
Size: 12cm
15cm

**Adson Brown
Tweezers Gold**



TG-REF:157
Size: 12cm
15cm

**Adson Brown
Tweezer Angular Gold**



TG-REF:158
Size: 12cm
15cm
18cm
20cm

**Adson Kocher
Tweezer Gold**



TG-REF:159
Size: 12cm
15cm
18cm
20cm

**Adson Tweezers
Serrated Gold**



TG-REF:160
Size: 10cm

**Micro Forceps
Straight TC**
Fine Teeth 5mm Wide



TG-REF:161
Size: 10cm

**Steven Serrated
Curved TC**
Fine Teeth 10mm Wide
Length:10cm



TG-REF:162
Size: 9cm

**Kirby Toothed
Forceps**



TG-REF:163
Size: 10cm

**Eye Suture
Forceps Serrated**

Surgical Forceps

TGIND
Instruments



TG-REF:A-156
Size: 15cm

Mariam Tweezers



TG-REF:A-157
Size: 15cm

Semken Tweezers



TG-REF:A-158
Size: 15cm

Self Locking Tweezers



TG-REF:A-159
Size: 15cm

London College Tweezers



TG-REF:A-160
Size: 15cm

Debakey Forceps
Angled TC



TG-REF:A-161
Size: 15cm

Thumb Dressing Forceps
TC



TG-REF:A-162
Size: 15cm

Debakey Forceps
TC



TG-REF:A-163
Size: 15cm

Corn Suture Plier

Microsurgery Tweezers

TGIND
Instruments



TG-REF:164
Size: 20cm

**Tebbetts Septal
Bayonet Forceps
TC**



TG-REF:165
Size: 20cm
18cm

**Adson Dressing
Bayonet Forceps**



TG-REF:166
Size: 12cm
15cm
18cm
20cm

**Adson Kocher
Tweezer Gold**



TG-REF:167
Size: 12cm
15cm
18cm
20cm

**Adson Tweezers
Serrated Gold**



TG-REF:168
Size: 10cm

**Micro Forceps
Straight TC**



TG-REF:169
Size: 10cm

**Steven Serrated
Curved TC**
Fine Teeth 10mm Wide
Length:10cm



TG-REF:170
Size: 9cm

**Kirby Toothed
Forceps**



TG-REF:171
Size: 10cm

**Eye Suture
Forceps Serrated
TC**

Surgical Needle Holder

TGIND
Instruments



TG-REF:172
Size: 14cm
16cm
18cm
20cm

Crilewood Needle Holder TC



TG-REF:173
Size: 14cm
16cm
18cm
20cm

Crilewood Needle Holder TC



TG-REF:174
Size: 14cm
16cm
18cm
20cm

Mayo Hegar Needle Holder



TG-REF:175
Size: 14cm
16cm
18cm
20cm

TC Ryder Needle Holder



TG-REF:176
Size: 14cm
16cm
18cm
20cm

Strnum Needle Holder TC



TG-REF:177
Size: 14cm
16cm
18cm
23cm

Stratte Valve Needle Holder



TAHIR GROUP OF INDUSTRIES



+92-300-6669737



TAHIR GROUP OF INDUSTRIES



TGIND.COM



TAHIR GROUP OF INDUSTRIES



tgindsale@gmail.com

12



TG-REF:178
Serration: 230mm
280mm
300mm
330mm

**Lahey Cholecystectomy
Forceps**



TG-REF:179
Size: 15cm
17cm
20cm

**Bayonet
Needle Holder**



TG-REF:180
Size: 14cm
16cm
18cm
20cm

**Mayo Hagar
Needle Holder**



TG-REF:181
Size: 18c
20c

**TC Wangenstein
Needle Holder**



TG-REF:182
Size: 14cm
18cm
20cm

**TC Sternal Wire Twister
Needle Holder**



TG-REF:183
Size: 14cm
16cm

**TC Webster
Needle Holder**





TG-REF:184
Serration: 230mm
280mm
300mm
330mm

Laney Cholecystectomy Forceps



TG-REF:185
Size: 14cm
16cm
18cm
20cm

Crilewood Needle Holder TC



TG-REF:186
Size: 27cm
Tip Size: 3mm
4mm

Endocervical Speculums



TG-REF:187
Size: 23cm

Teale Tenaculum Slight Curve



TG-REF:188
Size: 24cm

Skene Tenaculum Slight Curve



TG-REF:189
Size: 25.5cm
Curved Jaw 12mm

Sopher Standard Forceps TC



TG-REF:190
Size: 15.5cm
17cm
20cm
25cm
27cm
30cm

**Masson Needle Holder
Forceps TC**



TG-REF:191
Size: 15.5cm
17cm
20cm
25cm
27cm
30cm
40cm

**Mayo Masson
Needle Holder TC**



TG-REF:192
Size: 30cm
35cm

**Mueller
Needle Holder TC**



TG-REF:193
Size: 15.5cm
17cm
20cm
25cm
27cm
30cm

**Heaney
Needle Holder**



TG-REF:194
Size: 15cm
17.5cm
20cm
22cm

**French Eye
Needle Holder**



TG-REF:195
Size: 18cm

**Corwin Hegar Auto Wire
Twisting Forceps**





TG-REF:196
Tip| Size|
150 mm (15cm)
170 mm (16cm)
200 mm (20cm)

Martin
Needle Holder TC



TG-REF:197
Tip| Size|
145mm (15cm)

Baumgartner
Needle Holder TC



TG-REF:198
Jaw: 1.0mm

Size: 16cm
18cm
20cm

Diethrich
Needle Holder TC



TG-REF:199
Tip|
200 mm
245 mm
Size: 20cm
22cm

Mathieu
Needle Holder



TG-REF:200
Tip|
145 mm
170 mm
200mm
Size: 14cm
20cm
22cm

Mahieu
Needle Holder



TG-REF:201
Tip|
195mm
Size: 18cm

Lichtenberg's
Needle Holder





Tip: **150mm**
170mm
200mm
Size: **15.5cm**
17cm
20cm

Martin's Needle Holder TC



Tip: **260mm**
Size: **15.5cm**
17cm
20cm
25cm
27cm

Naunton-Morgan's Needle Holder TC

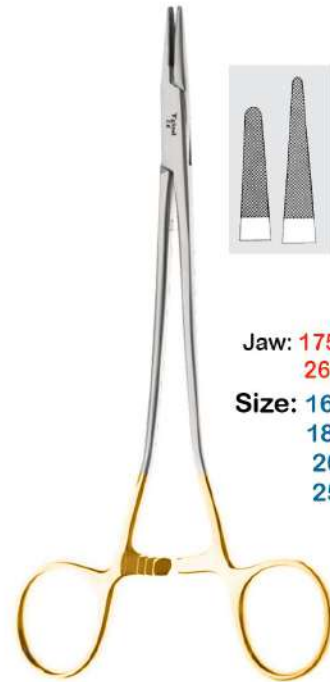

Jaw: **175mm**
260mm
Size: **16cm**
18cm
20cm
25mm

Sarot's Needle Holder TC

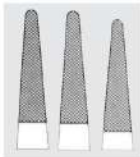

Tip: **200mm**
240mm
300mm
Size: **20cm**
22cm
27cm

Wertheim's Needle Holder



Size: **15cm**
17.5cm
20cm
22cm

**Turner Warwick Needle Holder
Offset Rings Gator Grip**

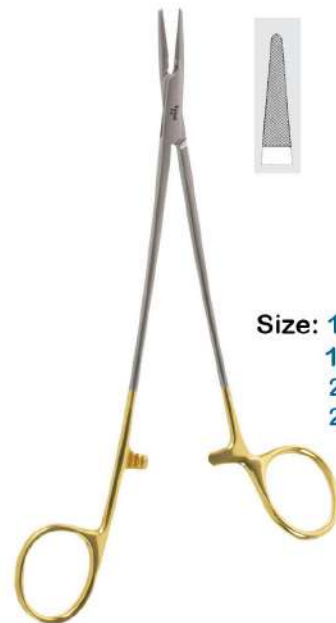

Size: **15cm**
17.5cm
20cm
22cm

**Rubio Needle Holder
Gold Offset Ring Handle**





TG-REF:202

Size:

(Blunt Right Hand) 27cm
(Blunt Left Hand) 27cm
(Sharp Right Hand) 27cm
(Sharp Left Hand) 27cm
(Blunt Right Hand) 28cm
(Blunt Left Hand) 28cm

**Deschamps Needle
Set Of 8**



TG-REF:203

Size:

(Sharp Right Hand) 20cm
(Sharp Left Hand) 20cm

**Hurd Needle
Set Of 2**



TG-REF:204

Size:

(Blunt Right Hand) 15cm
(Blunt Left Hand) 15cm

**Kronecker Needle
Set Of 2**



TG-REF:205

Size:

(Blunt) 15cm

Syme Suture Needle



TG-REF:206

Size:

(Small) 19.5cm 7.75"
(Small) 19.5cm 7.75"
(Long) 23cm 9"
(Long) 23cm 9"

**Reverdin Needle
Adjustable
4 Type**



TG-REF:207

Size:

(Short) 14.5cm 5.75"
(Short) 14.5cm 5.75"
(Short) 14.5cm 5.75"

**Reverdin Needle
Adjustable
3 Type**



Surgical Tweezers

TGIND
Instruments



TG-REF:208

Tip| Teeth| Size
 STR 1x2 4 1/2"
 STR 1x2 5 1/6"
 STR 1x2 5 3/8"
 STR 1x2 6 1/4"
 STR 1x2 7"
 STR 1x2 7 7/8"
 STR 1x2 9 3/8"
 STR 1x2 13 1/6"
 STR 2x3 4 1/2"
 STR 2x3 5 1/6"
 STR 2x3 5 3/8"
 STR 2x3 6 1/8"
 STR 2x3 7"
 STR 2x3 7 7/8"
 STR 3x4 5 3/6"
 STR 3x4 6 1/6"
 STR 3x4 7 7/8"



Tissue Forceps
Delicate



TG-REF:209

Tip| Teeth| Size
 STR SERR 4 1/2"
 STR SERR 5 1/6"
 STR SERR 5 3/8"
 STR SERR 6 1/4"
 STR SERR 12"
 CVD SERR 5 1/8"
 CVD SERR 5 1/2"

Dressing Forceps
Straight/Curved



TG-REF:210
Size: 15.5cm

McIndoe Dressing
Forceps



TG-REF:211

Size: 15cm
 17.5cm
 20cm
 22cm

Curtis Forceps



TG-REF:212

Teeth
 1x3
 1x2
 Size: 15cm
 17.5cm
 20cm
 22cm

Bonney Forceps



TG-REF:213
 Tip| Teeth| Size
 STR 7x8 15cm

Martin Forceps



TAHIR GROUP OF INDUSTRIES



+92-300-6669737



TAHIR GROUP OF INDUSTRIES



TGIND.COM



TAHIR GROUP OF INDUSTRIES



tgindsale@gmail.com



TG-REF:214

Tip	Size
1x2	(7 1/4")
2x3	(5 1/2")
3x4	(7 1/2")

Heaney Tissue Forceps

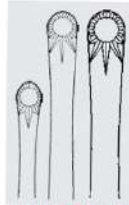

TG-REF:215

Tip	Size
200 mm	(7 7/8")
150 mm	(6")
260 mm	(10 1/4")

Dressing Forceps Straight/Curved



TG-REF:216

Tip	Size	Teeth
180 mm	(7")	toothed (3x4)
250 mm	(9 3/4")	toothed (4x5)
200 mm	(7 7/8")	toothed (3x4)

McIndoe Dressing Forceps



TG-REF:217

Size:

- 5 1/2", serrated
- 6 1/2", serrated
- 6 1/2", smooth
- 7 1/2" serrated
- 8" serrated
- 7 1/2", 1 x 2 teeth

Lucae Bayonet Dressing Forceps



TG-REF:218

Size:

- 5 1/2", serrated
- 6 1/2", serrated
- 6 1/2", smooth
- 7 1/2" serrated
- 8" serrated

Gruenwald Bayonet Dressing Forceps



TG-REF:219

- Size:**
- 15cm
 - 18.5cm
 - 20cm
 - 22cm

Jansen Bayonet Dressing Forceps



Surgical Forceps

TGIND
Instruments



TG-REF:220
Size: 15cm
18.5cm
20cm
22cm

Cushing Bayonet Forceps



TG-REF:221
Tip: 9x9 teeth
Size: 15cm
18.5cm
20cm
22cm

Brown Cushing Bayonet Forceps



TG-REF:222
Size: 15cm
18.5cm
20cm
22cm

Gerald Dressing Forceps



TG-REF:223
Size: 15cm
18.5cm
20cm
22cm

Gerald Bayonet Forceps



TG-REF:224
Size: 15cm
18.5cm
20cm

Troeltsch Bayonet Dressing Forceps



TG-REF:225
Size: 15cm
18.5cm

Semken Kocher Forceps



TAHIR GROUP OF INDUSTRIES



+92-300-6669737



TAHIR GROUP OF INDUSTRIES



TGIND.COM



TAHIR GROUP OF INDUSTRIES



tgindsale@gmail.com

Surgical Forceps

TGIND
Instruments



TG-REF:226
Tip|Teeth|Length
Str 1x2 6"7/8
Str 1x2 9"
Cvd 1x2 6"7/8

**Gerald Tissue Forceps
Delicate**



TG-REF:227
Tip| Length
Str 6"7/8
Str 9"

**Gerald Debakey
Forceps Delicate**



TG-REF:228
Tip| Length
Str 6"7/8
Str 9"

**Brophy Delicate
Forceps**



TG-REF:229
Tip| Length
1x2 6"7/8
1x2 9"

**Gillie Dissecting
Forceps**



TG-REF:230
Tip| Length
Hole 6"7/8
Hole 9"

**Corn Suture
Tweezers**



TG-REF:231
Tip| Length
Serr 6"7/8
Serr 9"

**Jansen Bayonet
Dressing Forceps**



TAHIR GROUP OF INDUSTRIES



+92-300-6669737



TAHIR GROUP OF INDUSTRIES



TGIND.COM



TAHIR GROUP OF INDUSTRIES



tgindsale@gmail.com

22

Surgical Forceps

TGIND
Instruments

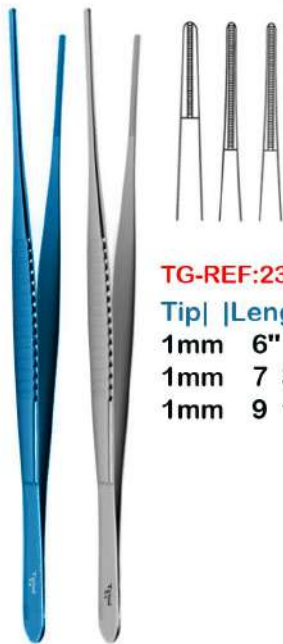

TG-REF:232

Tip| Length

1mm 6"
1mm 7 3/4"
1mm 9 1/2"

**Debaquey Ultra Fine
Tweezers**



TG-REF:233

Tip| Length

1.5mm 6"
1.5mm 7 7/8"
1.5mm 9 1/2"
1.5mm 11 3/4"

**Debaquey Atraumatic
Ultra Fine
Forceps**



TG-REF:234

Tip| Length

1.5mm 6"
1.5mm 7 7/8"
1.5mm 9 1/2"
1.5mm 11 3/4"

**Debaquey Atraumatic
Perma Sharp
Forceps**



TG-REF:235

Tip| Length

1.5mm 6"
1.5mm 7 7/8"
1.5mm 9 1/2"
1.5mm 11 3/4"

**Cooley Vascular
Forceps**

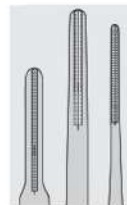

TG-REF:236

Tip| Length

2mm 6"
2mm 7 7/8"
2mm 9 1/2"
2.8mm 11 3/4"
2.8mm 6"
2.8mm 9 1/2"
2.8mm 11 3/4"
3.5mm 7 7/8"
3.5mm 9 1/2"
3.5mm 11 3/4"
3.5mm 13 3/4"

**Debaquey Atraumatic
Forceps**



TG-REF:237

Tip| Length

1.2mm 6"
1.5mm 7 7/8"
1.5mm 9 1/2"
1.5mm 11 3/4"

**Debaquey Atraumatic
Ultra Light
Forceps**



TAHIR GROUP OF INDUSTRIES



+92-300-6669737



TAHIR GROUP OF INDUSTRIES



TGIND.COM



TAHIR GROUP OF INDUSTRIES



tgindsale@gmail.com

23

Surgical Forceps

TGIND
Instruments



TG-REF:238
Tip| Length
Longitudinal 5"
Serrated

Mustarde Dissecting Suture Forceps



TG-REF:239
Tip| Length
1x2 5"

McIndoe Dissecting Forceps Serrated



TG-REF:240
Tip| Length
Str 6" 7/8
Str 9"

DeBakey Atraumatic Angled Forceps



TG-REF:241
Tip| Length
1x2 6" 7/8
1x2 9"

Adson Dissecting Forceps



TG-REF:242
Tip| Length
Durogrip 6"
Durogrip 9"

Wangensteen Tissue Forceps



TG-REF:243
Tip| Length
1.2mm 6"
1.5mm 7 7/8"
1.5mm 9 1/2"
1.5mm 11 3/4"

Adson Delicate Forceps

Hemostatic Forceps

TGIND
Instruments

Size:
12.5cm
18cm
20cm
21cm

TG-REF:0244



**Micro Halsted Kocher Clamp Forceps
Straight + Curved**

Size:
12.5cm
18cm
20cm
21cm

TG-REF:0245



**Mosquito Locking Clamp Forceps
Straight + Curved**

Size:
13cm
13.5cm
14cm
14.5cm
17cm

TG-REF:0246



**Pean Locking Clamp Forceps
Straight + Curved**

Size:
13cm
13.5cm
14cm
14.5cm
17cm

TG-REF:0247



**Kelly Locking Clamp Forceps
Straight + Curved**



TAHIR GROUP OF INDUSTRIES



+92-300-6669737



TAHIR GROUP OF INDUSTRIES



TGIND.COM



TAHIR GROUP OF INDUSTRIES



info@tgind.com

025



TG-REF:244

Tip	Length
2X2	6 1/8"
3X3	6 1/8"
3X3	8"
4X4	6 1/8"

**Lahey Goiter
Vulsellum forceps**



TG-REF:245

Tip	Length
5x6 teeth	6"

**Allis-Judd
Tissue Forceps**



TG-REF:246

Tip	Length
5x6 teeth	6"

**Boys-Allis Tissue
Forceps**



TG-REF:247

Size
6", Straight,
non-Crushing Serrated

**Glassman-Allis
intestinal clamp**



TG-REF:248

Size
7/8", straight, 5.0mm
wide jaws

**Allis-Coakley
Tonsil Forceps**



TG-REF:249

Size
6", Straight, 9x10 teeth

**Allis-Adair
Tissue Forceps**



Surgical Forceps



**Long Allis
Tissue Forceps**



TG-REF:250
Tip| Length
5x6 teeth 6 1/4"
7 7/8"
8 3/4"
10"
11 5/8"
11 3/4"
14"



**Allis-Babcock
Tissue Forceps**



TG-REF:251
Size:
6 1/4", angled shanks,
Atraumatic grooves,



**Allis-Coakley
Tonsil Forceps**



TG-REF:252
Size:
7 7/8", Strongly Curved,
5.0mm wide jaws



**Allis-Willauer
Tissue Forceps**



TG-REF:253
Size
Straight, 5x6 Teeth



**Lockwood-Allis
Tissue Forceps**



TG-REF:254
Size
6 1/4", Straight,
4x5 Teeth



**Revuelta-Garcia
Tissue Forceps**



TG-REF:255
Size
9 1/2", curved jaws



TAHIR GROUP OF INDUSTRIES



+92-300-6669737



TAHIR GROUP OF INDUSTRIES



TGIND.COM



TAHIR GROUP OF INDUSTRIES



tgindsale@gmail.com

Babcock Forceps



**Thoms-Allis
Tissue Forceps**

TG-REF:256
Size:
8", 6x7 teeth



**Babcock
Tissue Forceps
Titanium Coated**

TG-REF:257
Size:
6 1/4", angled shanks,
Atraumatic grooves,



**Babcock
Tissue Forceps**

TG-REF:258
Tip| Length
Straight, 6 1/4"
Atraumatic 7 1/2"
Grooves 8"
9"
12"
10"
14"
16"
18"



**Babcock
Tissue Forceps**

TG-REF:259
Tip| Length
Straight 5 1/4"
Delicate 6 1/4"
Atraumatic 6 1/8"
Grooves



**Babcock
Tissue Forceps TC**

TG-REF:260
Tip| Length
Straight 5 1/4"
Serrated 6 1/4"
Jaw TC 7"
8"



**Babcock
Tissue Forceps**

TG-REF:261
Tip| Length
Straight 18"
Atraumatic
Grooves
Double Action



Collin Forceps

TGIND
Instruments



TG-REF:262

**Turner-Babcock
Tissue Forceps**



TG-REF:263

Size:
Forceps, 7 1/2", Straight,
15.0mm wide serrated jaws

**Collins-Duval Tissue
Grasping Forceps**



TG-REF:264

Size:
Forceps, 7 1/2", Straight,
30.0mm wide serrated jaws

**Collins-Duval Tissue
Grasping Forceps**



Size: TG-REF:265
Forceps, 7 1/2", Straight,
15.0mm wide wide Atraumatic

**Collin Atraumatic
Grasping Forceps**



Size: TG-REF:266
Forceps, 7 1/2", Straight,
30.0mm wide Atraumatic

**Collin Atraumatic
Grasping Forceps**

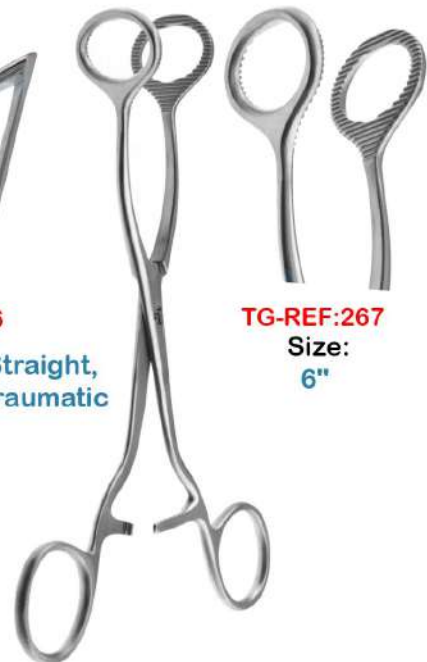

TG-REF:267
Size:
6"

**Collins Tongue
Seizing Forceps**



TAHIR GROUP OF INDUSTRIES



+92-300-6669737



TAHIR GROUP OF INDUSTRIES



TGIND.COM



TAHIR GROUP OF INDUSTRIES



tgindsale@gmail.com

Intestinal Clamp



TG-REF:268

Tip	Length
1x2	6 1/8"
1x2	7 7/8"

**Allen Intestinal Clamp
Pediatric Longitudinal
Serrated**



TG-REF:269

Tip	Length
1x2	6 1/8"
1x2	7 7/8"

**Allen Intestinal Clamp
Straight Longitudinal
Serrated**



Size: TG-REF:270

7 1/4", Straight, Longitudinal
Serrated jaws

**Bainbridge Intestinal Clamp
Straight Longitudinal
Serrated**



TG-REF:271

Size: 6 3/4", Straight, 4.0cm Long
Atraumatic jaws

**Bainbridge Intestinal
Atraumatic Jaw
Straight**



Size: TG-REF:272

6 3/4", Curved, 4.0cm Long
Atraumatic jaws

**Bainbridge Intestinal
Atraumatic Jaw
Curved**



Size: TG-REF:273

6 3/4", Curved, 4.0cm Long
Atraumatic jaws

**Bainbridge Intestinal Clamp
Longitudinal
Curved**



Intestinal Clamp



TG-REF:274

Tip	Length
STR	6 1/2"
STR	9 1/4"
CVD	6 1/2"
CVD	9 1/4"

**Doyen Intestinal Clamp
Serrated Jaw
Curved**



TG-REF:275

Tip	Length
STR	6 1/2"
STR	9 1/4"
CVD	6 1/2"
CVD	9 1/4"

**Doyen Intestinal Clamp
Serrated Jaw
Straight**



TG-REF:276

Tip	Length
STR	6 1/2"
STR	9 1/4"
CVD	6 1/2"
CVD	9 1/4"

**Doyen Intestinal Clamp
Serrated Atraumatic
Curved**



TG-REF:277

Tip	Length
STR	6 1/2"
STR	9 1/4"
CVD	6 1/2"
CVD	9 1/4"

**Doyen Intestinal Clamp
Serrated Atraumatic
Straight**



TG-REF:278

Tip	Length
STR	6 1/8"
STR	8 1/4"
STR	9"

**Kocher Intestinal
Longitudinal Serrated
Straight**



TG-REF:279

Tip	Length
CVD	5 1/4"
CVD	8 1/4"
CVD	9"

**Kocher Intestinal Clamp
Longitudinal Serrated
Curved**



Intestinal Clamp



TG-REF:280
Tip | Length
220mm | 8 5/8"
250mm | 9 7/8"
280mm | 11"

**Kocher Intestinal
Elastic Blade
Straight**



TG-REF:281
Tip | Length
220mm | 8 5/8"
250mm | 9 7/8"
280mm | 11"

**Kocher Intestinal
Elastic Blade
Curved**



TG-REF:282
Tip | Length
200mm | 8"

**Hartmann Intestinal
Elastic Blade
Straight**



TG-REF:283
Tip | Length
200mm | 8"

**Hartmann Intestinal
Elastic Blade
Curved**



TG-REF:284
Tip | Length
250mm | 9 7/8"

**Mayo-Robson's Atraumatic
Intestinal Clamp
Straight**



TG-REF:285
Tip | Length
250mm | 9 7/8"

**Mayo-Robson's Atraumatic
Intestinal Clamp
Curved**



Gall Duct Clamps



TG-REF:286
Tip| Length
130mm | 5 1/8"

**Kleinschmidt's
Appendectomy
Clamp Forceps**



TG-REF:287
Tip| Length
155 mm | 6 1/8"

**Benson's Pylorus
Spreader Forceps
Curved**



TG-REF:288
Size:
8-1/2

**TAUFIC Cholangiography
Clamp**



TG-REF:289
Size:
7 1/4", Curved,
Longitudinal Serrated

**Lahey Gall Duct
Forceps Curved**



TG-REF:290
Tip| Length
Curved | 8 3/4"

**Desjardins Gall Duct
Forceps**



TG-REF:291
Tip| Length
250mm | 9 7/8"

**Mixer Gall Duct
Forceps**



TAHIR GROUP OF INDUSTRIES



+92-300-6669737



TAHIR GROUP OF INDUSTRIES



TGIND.COM



TAHIR GROUP OF INDUSTRIES



tgindsale@gmail.com

Gall Duct Forceps



TG-REF:292
Size:
8", Curved, Serrated

Shallcross Cystic Duct Forceps



TG-REF:293
Size:
8", Curved, Serrated

Lower Gall Duct Forceps



TG-REF:294
Size:
T-shaped jaws with
Delicate Serrations
6 1/8"

Pratt-Smith Hemostatic Forceps



TG-REF:295
Size:
55mm Jaw,
Overall Length
240mm, 300mm,
340mm

Purse String Forceps



TG-REF:296
Size:
Short Curved Tip
Long Curved Tip
23cm

Gray Cystic Gall Duct Forceps



TG-REF:297
Size:
Fenestrated Cup
Curved Tip
Straight Tip
8 1/4"

Mayo Blake Gall Stone Forceps



Stone Forceps

TGIND
Instruments



TG-REF:298
Size:
8 3/4", Straight

Blake Gall Stone Forceps



TG-REF:299
Size:
8 3/4", Curved

Blake Gall Stone Forceps



TG-REF:300
Tip | Size |
Oval 8 7/8"
Oval 8 7/8"
Tapered 8 7/8"
Tapered 8 7/8"

Pratt-Smith Hemostatic Forceps



TG-REF:301
Size:
9 1/4", Quarter Curved jaws

Randall Kidney Stone Forceps



TG-REF:302
Size:
9 1/4", Half Curved Jaws

Randall Kidney Stone Forceps



TG-REF:303
Size:
9 1/4", Three-Quarter Curved

Randall Kidney Stone Forceps



TAHIR GROUP OF INDUSTRIES



+92-300-6669737



TAHIR GROUP OF INDUSTRIES



TGIND.COM



TAHIR GROUP OF INDUSTRIES



tgindsafe@gmail.com

34



TG-REF:304

Size:

9 1/4", full curved jaws

Randall Kidney Stone Forceps



TG-REF:305

Size:

9 1/4", right angled, 1" jaw length

Glassman Anterior Resection Clamp



TG-REF:306

Size:

9 1/4", right angled, 2" jaw

Glassman Anterior Resection Clamp



TG-REF:307

Size:

9 1/4", right angled, 3" jaw

Glassman Anterior Resection Clamp



TG-REF:308

Size:

9 1/4", Half Curved Jaws

Glassman Gastroenterostomy Clamp



TG-REF:309

Size:

11 1/2", Straight, Non-Crushing Serrated Jaws

Glassman Gastroenterostomy Clamp



TAHIR GROUP OF INDUSTRIES



+92-300-6669737



TAHIR GROUP OF INDUSTRIES



TGIND.COM



TAHIR GROUP OF INDUSTRIES



tgindsale@gmail.com



TG-REF:310
Size:
9 1/2", Straight,
2 1/2" long
atraumatic
serrated jaws

**Glassman Stomach
/intestinal
Forceps**



TG-REF:311
Size:
9 1/2", angled,
2 1/2" long
atraumatic
serrated jaws

**Glassman Stomach
/intestinal
Forceps**



TG-REF:312
Size:
atraumatic intestinal-
and stomach
clamp forceps
straight, 330 mm

**Scudder's Intestinal-
Stomach Clamp Forceps**



TG-REF:313
Size:
atraumatic intestinal-
and stomach
clamp forceps
straight, 330 mm

**Scudder's Intestinal-
Stomach Clamp Forceps**



TG-REF:314
Size:
7", 10" straight,
serrated jaws

**Rampley Sponge
Forceps**



TG-REF:315
Size:
11 1/2", Straight,
Non-Crushing
Serrated Jaws

**Sims-Maier Sponge
Forceps**



TAHIR GROUP OF INDUSTRIES



+92-300-6669737



TAHIR GROUP OF INDUSTRIES



TGIND.COM



TAHIR GROUP OF INDUSTRIES



tgindsale@gmail.com



TG-REF:317
Size:
Straight, 220 mm
10 3/8"

Ulrich's Sponge Dressing Forceps



TG-REF:318
Size:
Curved, 220 mm
10 3/8"

Ulrich's Sponge Dressing Forceps



TG-REF:319
Size:
Straight, 265 mm
10 3/8"

Ulrich's Sponge Dressing Forceps



TG-REF:320
Size:
Curved, 265 mm
10 3/8"

Ulrich's Sponge Dressing Forceps



TG-REF:321
Size:
Straight, 7 7/8"

Gross Sponge Forceps



TG-REF:322
Size:
Curved, 7 7/8"

Gross Sponge Forceps



Sponge Forceps

TGIND
Instruments



TG-REF:323
Size:
Straight
1/4", 6 1/4", 7 1/4"

Lister Sponge Forceps



TG-REF:324
Size:
Straight
7", 9 1/2", 12"
14", 16"

Foerster Sponge Forceps



TG-REF:325
Size:
Curved
7", 9 1/2", 12"
14", 16"

Foerster Sponge Forceps



TG-REF:326
Size:
Straight /Curved
12"
14", 16", 18"

Foerster Sponge Forceps



TG-REF:327
Size:
Straight Smooth jaws
7", 9 1/2", 12"
14", 16"

Foerster Sponge Forceps



TG-REF:328
Size:
Curved Smooth jaws
7", 9 1/2", 12"
14", 16"

Foerster Sponge Forceps



TAHIR GROUP OF INDUSTRIES



+92-300-6669737



TAHIR GROUP OF INDUSTRIES



TGIND.COM



TAHIR GROUP OF INDUSTRIES



tgindsale@gmail.com

Sponge Forceps

TGIND
Instruments



TG-REF:329
Size:
Straight
1 1/4", 6 1/4", 7 1/4"

Ballenger Sponge Forceps



TG-REF:330
Size:
Straight
7", 9 1/2", 12"
14", 16"

Kelly Placenta Sponge Forceps



TG-REF:331
Size:
Curved
7", 9 1/2", 12"
14", 16"

Magill Forceps

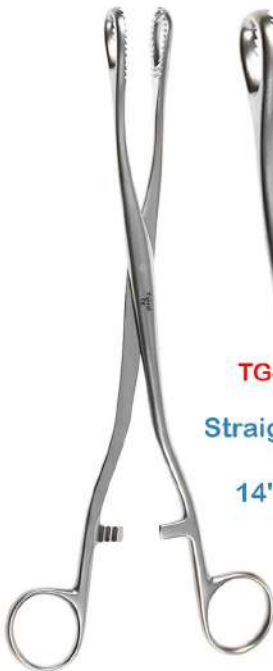

TG-REF:332
Size:
Straight /Curved
12"
14", 16", 18"

Foerster Sponge Forceps



TG-REF:333
Size:
Straight Smooth jaws
7", 9 1/2", 12"
14", 16"

Foerster Sponge Forceps



TG-REF:334
Size:
Curved Smooth jaws
7", 9 1/2", 12"
14", 16"

Foerster Sponge Forceps



TAHIR GROUP OF INDUSTRIES



+92-300-6669737



TAHIR GROUP OF INDUSTRIES



TGIND.COM



TAHIR GROUP OF INDUSTRIES



tgindsale@gmail.com



TG-REF:335
Size:

20mm Oval Serrated,
110mm Shaft, 9.5" (24cm)
Working Length, 13.5" (34cm)

**Foerster MICS VATS
Thoracoscopic clamp**



TG-REF:336
Size:

Curved Right 12mm Oval
Serrated jaws,
7mm Shaft, w/Ratchet, 9.5" (24cm)
Working Length, 13.5" (34cm)

**Foerster MICS VATS
Thoracoscopic clamp**



TG-REF:337
Size:

Curved Left 12mm Oval
Serrated jaws,
7mm Shaft, w/Ratchet, 9.5" (24cm)
Working Length, 13.5" (34cm)

**Foerster MICS VATS
Thoracoscopic clamp**



TG-REF:338
Size:

Deeply Curved Left
12mm Oval Serrated,
7mm Shaft, w/Ratchet, 9.5" (24cm)
Working Length, 13" (33cm)

**Foerster MICS VATS
Thoracoscopic clamp**



TG-REF:339
Size:

Left 6mm Wide jaws,
7mm Shaft, 9.5" (24cm)
Working Length 13.5" (34cm)

**VATS Allis Forceps
- Curved**



TG-REF:340
Size:

Left 6mm Wide jaws,
7mm Shaft, w/Ratchet 9.5" (24cm)
Working Length 13.5" (34cm)

**VATS Allis Forceps
- Curved**



TAHIR GROUP OF INDUSTRIES



+92-300-6669737



TAHIR GROUP OF INDUSTRIES



TGIND.COM



TAHIR GROUP OF INDUSTRIES



tgindsale@gmail.com

Debakey Clamps

TGIND
Instruments



TG-REF:341
Size:

mm Oblong Serrated jaws,
5mm Shaft,
w/Ratchet, 9" (23cm)
Working Length,
14.25" (36cm)

**VATS Node Grasping
Forceps - Straight**



TG-REF:342
Size:

1mm Oblong Serrated jaws,
5mm Shaft,
w/Ratchet, 9" (23cm)
Working Length,
14.25" (36cm)

**VATS Node Grasping
Forceps - Curved**



TG-REF:343
Size:

65mm Curved 1x2 DeBakey
Atraumatic jaws
10mm Shaft, w/Lock,
Angled Shanks,
17cm Working Length,
9.75" (24.8cm)

**Thoracoscopic DeBakey
Clamp**



TG-REF:344
Size:

65mm Curved Right 1x2
DeBakey Atraumatic jaws,
10mm Shaft, w/Lock, 17cm
Working Length
10.25" (26.4cm)

**Thoracoscopic DeBakey
Clamp**



TG-REF:345
Size:

100mm Curved 1x2
DeBakey Atraumatic jaws,
10mm Shaft, w/Lock,
38.5cm Working Length,
19.25" (49cm)

**Thoracoscopic DeBakey
Clamp**



TG-REF:346
Size:

65mm Curved 1x2
DeBakey Atraumatic jaws,
10mm Shaft, w/Lock,
17cm Working Length,
10.25" (26.4cm)

**Thoracoscopic DeBakey
Clamp**



TAHIR GROUP OF INDUSTRIES



+92-300-6669737



TAHIR GROUP OF INDUSTRIES



TGIND.COM



TAHIR GROUP OF INDUSTRIES



tgindsale@gmail.com

41



TG-REF:347

Size:

115mm Straight 1x2
DeBakey Atraumatic Tapered jaws,
10mm Shaft, w/Ratchet,
27cm Working Length,
14.75" (37.5cm)

**Thoracoscopic DeBakey
Clamp**



TG-REF:348

Size:

95mm Fully Curved
1x2 DeBakey Atraumatic jaws,
10mm Shaft,
25cm Working Length,
Stainless Steel,
14" (35.5cm)

VATS Harken #2 Clamp



TG-REF:349

Size:

95mm Fully Curved 1x2
DeBakey Atraumatic jaws,
10mm Shaft, 25cm
Working Length,
14" (35.5cm)

VATS Harken #2 Clamp



TG-REF:350

Size:

140mm Fully Curved 1x2
DeBakey Atraumatic jaws,
10mm Shaft,
31cm Working Length,
w/Ratchet,
15.5" (39.5cm)

VATS Semb Clamp



TG-REF:351

Size:

Curved 1x2
DeBakey Atraumatic jaws,
10mm Shaft, Angled Shanks,
w/Ratchet, 21cm
Working Length, 12.25" (31cm)

**Thoracoscopic Lambert
Kay Clamp**



TG-REF:352

Size:

95mm Curved 1x2
DeBakey Atraumatic jaws,
10mm Shaft,
25cm Working Length,
w/Ratchet,
14" (35.5cm)

**Thoracoscopic DeBakey
Clamp**



VATS Clamp

TGIND
Instruments



TG-REF:353
Size:

- Curved Left 15mm
Triangular Serrated ring jaws,
10mm shaft, 9.25"
(23.5cm)
Working Length,
13.5" (34cm)

VATS Duval Clamp



TG-REF:354
Size:

Curved Left 15mm
Triangular Serrated ring jaws,
10mm shaft, 9.25"
(23.5cm)
Working Length,
13.5" (34cm)

VATS Duval Clamp



TG-REF:355
Size:

Straight TC Coated jaws,
w/Lock, 5mm
Shaft, 6.5" (16.5cm)
Working Length,
11.65" (29.6cm)

MIS Needle Holder



TG-REF:356
Size:

Straight Heavy jaws w/TC Inserts,
7mm Shaft, w/Ratchet,
16cm Working Length,
11.25" (28.5cm)
(For 4-0 Suture)
21cm Working
Length,, 13.5" (34cm)

VATS Heavy Needle Holders



TG-REF:357
Size:

Curved Heavy jaws w/TC Inserts,
7mm Shaft, w/Ratchet,
16cm Working Length,
Stainless Steel,
11.25" (28.5cm)
(For 4-0 Suture)

VATS Heavy Needle Holders



TG-REF:358
Size:

Straight X-Heavy jaws
w/TC Inserts,
7mm Shaft, w/Ratchet,
16cm Working Length,
Stainless Steel,
11.25" (28.5cm)
(For 2-0 Suture)
21cm Working Length,
13.5" (34cm)

VATS X Heavy Needle Holders



TAHIR GROUP OF INDUSTRIES



+92-300-6669737



TAHIR GROUP OF INDUSTRIES



TGIND.COM



TAHIR GROUP OF INDUSTRIES



tgindsale@gmail.com

43



TG-REF:359

Size:

14", straight, 1x2 teeth,
serrated jaws
14", 16", 13 3/4"

**Rochester-Ochsner
Forceps**



TG-REF:360

Size:

Curved, 1x2 teeth,
serrated jaws
14", 16", 13 3/4"

**Rochester-Ochsner
Forceps**



TG-REF:361

Length:

6 1/4"
7 7/8"
9"
10 1/4"

**Rochester-Carmalt
Artery Forceps**



TG-REF:362

Tip: Length:

Curved 6 1/4"
Curved 7 7/8"
Curved 9"
Curved 10 1/4"

**Rochester-Carmalt
Artery Forceps**



TG-REF:363

Tip: Length:

Curved 9"
Curved 9 1/2"

Moynihan Gall Duct Forceps



TG-REF:364

Tip: Length:

Heavy Cvd 7 1/2"
U-Curved 7 1/2"

Negus Tonsil Forceps



TAHIR GROUP OF INDUSTRIES



+92-300-6669737



TAHIR GROUP OF INDUSTRIES



TGIND.COM



TAHIR GROUP OF INDUSTRIES



tgindsale@gmail.com

Tonsil Forceps

TGIND
Instruments



TG-REF:365
Tip: Length:
 Slight-Cvd 7 1/4"
 Cvd 7 1/4"
 Slight-Cvd 7 1/4"
 Cvd 7 1/4"

**Schnidt
Tonsil forceps**



TG-REF:366
Tip: Length:
 Straight 7 1/2"

**Schnidt-Boettcher
Tonsil Forceps**



TG-REF:367
Tip: Tip: Length:
 Serrated Serr 1x2 5"
 Serrated Serr 1x2 6"
 Serrated Serr 1x2 7 7/8"
 Serrated Serr 1x2 7 7/8"

**Mosquito Forceps
Hemostatic Straight**



TG-REF:368
Tip: Tip: Length:
 Serrated Serr 1x2 5"
 Serrated Serr 1x2 6"
 Serrated Serr 1x2 7 7/8"
 Serrated Serr 1x2 7 7/8"

**Mosquito Forceps
Hemostatic Curved**



TG-REF:369
Tip: Length:
 Straight 5"
 Straight 7 1/2"

**Jacobson Mosquito
Forceps Straight**



TG-REF:370
Tip: Length:
 Curved 5"
 Curved 7 1/2"

**Jacobson Mosquito
Forceps Curved**



TG-REF:371
Tip: Length:
 Serr 1x2 7 1/4"
 Serr 1x2 7 1/4"
 Serr 1x2 7 1/4"
 Serr 1x2 7 1/4"

Ochsner Dixon Artery Forceps STR-CVD



TG-REF:372
Tip: Length:
 Serrated 5"
 Serrated 6"
 Serrated 7 7/8"
 Serrated 7 7/8"

Leriche Artery Forceps STR-CVD



TG-REF:373
Tip: Tip: Length:
 Straight Serr 5 1/2"
 Straight Serr 1x2 5 1/2"
 Straight Serr 6 1/4"
 Straight Serr 1x2 6 1/4"
 Curved Serr 5 1/2"
 Curved Serr 1x2 5 1/2"
 Curved Serr 6 1/4"
 Curved Serr 1x2 6 1/4"

Coller Artery Forceps STR-CVD



TG-REF:374
Tip: Length:
 Serrated 6 1/4"
 Serrated 6 1/4"

Rankin Kelly Forceps STR-CVD



TG-REF:375
Tip: Length:
 Serrated 6 1/4"
 Serrated 6 1/4"

Titanium Rankin Kelly Forceps STR-CVD



TG-REF:376
Tip: Length:
 Curved 6"
 Curved 7"
 8"
 9"
 10"
 12"
 14"

Crilewood Needle Holder Tungsten Carbide



TG-REF:377

Tip: Length:
Serrated 7 1/4"
Serrated 7 1/4"

**Birkett Artery Forceps
STR-CVD**



TG-REF:378

Tip: Length:
Serrated 7 1/4"

**Nissen Hemostatic
Forceps STR**



TG-REF:379

Tip: Length:
Straight 7 1/4"
Curved 7 1/4"

**Adson Tonsil
Forceps STR-CVD**



TG-REF:380

Tip: Length:
Serr STR 8"
Serr CVD 8"
Serr STR 1x2 8"
Serr CVD 1x2 8"

**Rankin Kelly
Forceps STR-CVD**



TG-REF:381

Tip: Length:
Straight 7 7/8"
STR 1X2 7 7/8"
Curved 7 7/8"
CVD 1X2 7 7/8"
Hvy Curved 7 3/4"

**Heiss Artery Forceps
STR-Deep CVD**



TG-REF:382

Tip: Length:
Straight 9 5/8"
Curved 9 5/8"

**Bengolea Delicate
Forceps STR-CVD**



TAHIR GROUP OF INDUSTRIES



+92-300-6669737



TAHIR GROUP OF INDUSTRIES



TGIND.COM



TAHIR GROUP OF INDUSTRIES



tgindsale@gmail.com

Artery Forceps

TGIND
Instruments



TG-REF:383
Tip: Length:
Delicate, full Cvd 5 1/2"
Delicate, full Cvd 7"
Delicate, full Cvd 7 7/8"
Delicate, full Cvd 9"
Delicate, full Cvd 11"

Gimini Right Angle Forceps



TG-REF:384
Tip: Length:
Delicate, Right Angled 6 3/8"
Serrated 7 7/8"
9 5/8"
10 3/4"
12"

Kantrowitz Right Angle Forceps



TG-REF:385
Tip: Length:
Slight Cvd 11 3/4"
Heavy Cvd 11 1/2"
Slight Cvd 13 3/4"
Cvd 13 3/4"
Heavy Cvd 13 3/4"

Zenker Ligature Forceps



TG-REF:386
Tip: Length:
0# 7 3/4"
1# 8"
2# 8 3/4"
3# 8 7/8"
4# 8 3/4"
5# 8 3/4"
6# 9"
1# 8 7/8"
2# 11 5/8"

Overholt Geissendoerfer Forceps



TG-REF:387
Tip: Length:
0# 8 1/2"
1# 8 1/4"
2# 8 3/4"
3# 8 7/8"
6# 11 5/8"
0# 11 5/8"
1# 11 3/4"
6#

Overholt Forceps



TG-REF:388
Tip: Length:
right angled, serrated jaws 7"
11"

Meeker Artery Forceps



TAHIR GROUP OF INDUSTRIES



+92-300-6669737



TAHIR GROUP OF INDUSTRIES



TGIND.COM



TAHIR GROUP OF INDUSTRIES



tgindsale@gmail.com

48

Artery Forceps

TGIND
Instruments



TG-REF:389
Tip: Curved Serrated Jaws
Length: 8" (20cm)

O'Shaughnessy Forceps
Titanium



TG-REF:390
Tip: Curved
Length: 7 1/2"
Curved 7 3/4"
Curved 8 5/8"
Curved 9"
Curved 11"

Lahey Forceps



TG-REF:391
Tip: Delicate, fully curved, serrated
Length: 14"

Mixer Thoracic Forceps



TG-REF:392
Tip: Full Curved
Length: 12"

Harrington Mixer Forceps



TG-REF:393
Tip: Strongly curved, serrated
Length: 7 1/4"
11"

Lawrence Forceps



TG-REF:394
Tip: Curved
Length: 8"

Wikstroem Hemostatic Forceps



TAHIR GROUP OF INDUSTRIES



+92-300-6669737



TAHIR GROUP OF INDUSTRIES



TGIND.COM



TAHIR GROUP OF INDUSTRIES



tgindsale@gmail.com

49

Artery Forceps

TGIND
Instruments



TG-REF:389

Tip: Curved Shanks, Curved, Serrated
Length: 10 1/4"

**Rienhoff Swan-Neck
Clamp Forceps**



TG-REF:390

Tip: Angled to Right Fully Serrated 40mm Jaw, Overall Length 255mm

**McDougal Clamp
Forceps**



TG-REF:391

Tip: Longitudinal Serrated Curved
Length: 10"
14"

**Collier-Anderson-DeBakey
Artery Clamp Forceps**



TG-REF:392

Tip: Curved, Horizontal Serrated Jaws
Length: 10"
14"

**Collier DeBakey
Forceps**



TG-REF:393

Tip: Fully Curved, Longitudinal Serrated Jaws
Length: 9 1/2"

**Finocchio Thoracic
Forceps**



TG-REF:394

Tip: Serr Curved Serr Straight
Length: 5.5"
8"

**Rochester-Pean
Hemostatic Artery Forceps**



TAHIR GROUP OF INDUSTRIES



+92-300-6669737



TAHIR GROUP OF INDUSTRIES



TGIND.COM



TAHIR GROUP OF INDUSTRIES



tgindsale@gmail.com

50



TG-REF:395
Length:
 3"
 3 1/2"
 4"
 5 1/4"
 6"

**Backhaus Towel
Clamp Forceps Titanium**



TG-REF:396
Tip: 3"
Length: 3 1/2"
 with clip, for 4"
 tubing up to 5/8" 5 1/4"
 6"

**Backhaus Towel
Clamp Forceps**



TG-REF:397
Tip: 3"
Length: 3 1/2"
 with ball 4"
 on jaw 5 1/4"
 6"

**Roeder Towel
Clamp Forceps**



TG-REF:398
Tip: ball and socket
Length: 3"
 3 1/2"
 4"
 5 1/4"
 6"

**Ball & Socket
Towel Clamps**



TG-REF:399
Tip: Straight
Length: 6.5"

**Bernhard Towel
Clamp Forceps**



TG-REF:400
Tip: Cross Locking
Length: 3 1/4"

**Jones Towel
Clamp Forceps**



TG-REF:401
Tip: Length:
Straight, Serrated
jaws, for
5/8" tubing 7 1/4"

**Lorna Towel
Clamp Forceps**



TG-REF:402
Length:
5.25"

**Vorse Tube
Occluding Forceps**



TG-REF:403
Length:
4"
5 1/2"

**Non-perforating
Towel clamp forceps**



TG-REF:404
Length:
4", curved,
serrated jaws

**Hoff non-perforating
Towel Clamp**



TG-REF:405
Length:
5 3/4",
non-perforating

**Peers Towel
clamp Forceps**



TG-REF:406
Length:
3 3/8",
cross-action
sharp tips

**Schaedel Towel
Clamp Forceps**





TG-REF:407
Size:
 5 3/8", large,
 8.0mm
 flattened end,
 2.0mm bulbous
 tip
Size:
 5 1/8", small,
 6.0mm flattened
 end, 1.5mm
 bulbous tip, flat handle

**Jameson
Muscle Hook**



TG-REF:408
Size:
 5 1/8",
 delicate,
 10.0mm blunt
 spatulated tip

**Helveston
Muscle Hook**



TG-REF:409
Size:
 curved,
 6.0mm
 blunt hook

**Stevens
Tenotomy Hook**



TG-REF:410
Size:
 5 1/8",
 flat 7.0mm
 wide hook end

**Green Strabismus
Hook**



TG-REF:411
Size:
 5 5/8",
 flattened 13.0mm
 Graefe-type hook
 end with 1.5mm
 oval hole

**Gass retinal
Detachment Hook**



TG-REF:412
Size:
 5 3/8",
 size #1,
 small,
 8.0mm
 flat hook,

**Von Graefe
Strabismus Hook**





TG-REF:413
Size:
5 5/8", original model,

Crawford Retrieving Hook



TG-REF:414
Size:
5", fully curved,
2 sharp prongs,
2.0mm spread

Guthrie Fixation Hook



TG-REF:415
Size:
4 5/8", straight shaft,
0.5mm "K" hook

Kuglen iris Hook
& Lens Manipulator



TG-REF:416
Size:
4 1/2", delicate,
pigtail tip

Devgan Intraocular
Suturing Hook



TG-REF:417
Size:
8", 1 blunt prong,
3.0mm wide,

Adson Dura
Nerve Hook



TG-REF:418
Size:
6 3/4", angled 90°,
3.0mm blunt hook

Allport incus Hook





TG-REF:419
Size/Tip:
5", 1 sharp prong,

Skin Hook



TG-REF:420
Size/Tip:
straight shaft,
angled 90°,
0.33mm long tip

Austin Foot Plate Hook



TG-REF:421
Size/Tip:
6", curved,
sharp prong

Ingrown Tissue Hook



TG-REF:422
Size:
9", Large, 1
Sharp Prong,
25.0mm wide

**Bone Hook
T Handle**



TG-REF:423
Size:
large, 1 sharp prong,
25.0mm wide

**Bone Hook
Grip Handle**



TG-REF:424
Size:
7", small, 1 sharp
prong, 2.0mm wide

**Converse-Gillies
Skin Hook**





TG-REF:425
Size/Tip:
5 1/2", 1 sharp prong,
small deep curve,

Cottle Skin Hook



TG-REF:426
Size/Tip:
5 3/8", 2 sharp prongs,
12.0mm spread

Cottle-Joseph Skin Hook



TG-REF:427
Size/Tip:
8", blunt,
7.0mm hook

Crile Nerve Hook



TG-REF:428
Size/Tip:
7 1/2", small,
4.0mm ball tip
Size/Tip:
7 1/2", small,
6.0mm ball tip

Cushing Nerve Hook



TG-REF:429
Size/Tip:
9", straight shaft,
angled 90°, blunt tip

Dandy Nerve Hook



TG-REF:430
Size/Tip:
7", small, 1 sharp
prong, 2.0mm wide

Converse-Gillies
Skin Hook





TG-REF:431
Size/Tip:
9", angled,
5.0mm tip

**Cushing-Gasserian
Ganglion Hook**



TG-REF:432
Size/Tip:
extra small, angled 90°,
1.5mm blunt tip

Day Ear Hook



TG-REF:433
Size/Tip:
5", 1 sharp prong,
2.5mm wide

Frazier Skin Hook



TG-REF:434
Size/Tip:
6", 2 sharp prongs,
2.5mm spread

Freer Skin Hook



TG-REF:435
Size/Tip:
5", large, 2 sharp prongs,
2.0mm spread

Guthrie Skin Hook



TG-REF:436
Size/Tip:
5", 2 sharp prongs,
adjustable spread

Penn (Humby) Swivel Hook





TG-REF:437
Size/Tip:
6 1/4", 1
sharp prong

Joseph Skin Hook



TG-REF:438
Size / Tip:
6 1/4", 2 sharp prongs,
2.0mm spread
10.0mm spread
5.0mm spread
7.0mm spread
12.0mm spread

Joseph Skin Hook



TG-REF:439
Size/Tip:
6", 1 sharp prong,
3.0mm diameter

Kleinert-Kutz skin hook



TG-REF:440
Size/Tip:
7", angled 90°,
1.0mm ball tip

Lillie Ear Hook,



TG-REF:441
Size / Tip:
5 5/8", 2 sharp prong,
2.0mm spread
5.0mm spread,
7.0mm spread,
10.0mm spread,

Micro Skin Hook



TG-REF:442
Size/Tip:
7 1/2", angled 90°,
small, blunt tip

R-Style Nerve Hook





TG-REF:443
Size/Tip:
6 1/2", angled shaft,
angled up, 0.4mm
long anterior tip

Schuknecht foot plate hook



TG-REF:444
Size / Tip:
6"straight shaft,
angled 90°,
6.0mm long blunt tip,

Sisson Nerve Hook



TG-REF:445
Size/Tip:
5", 1 sharp prong,
3.5mm wide

Weiner Skin Hook



TG-REF:446
Size/Tip:
7 3/4", 1 sharp prong,
3.0mm wide, black finish,

Weary Nerve hook



TG-REF:447
Size / Tip:
9 1/2", angled 90°,
graduated, 6.0mm tip

Vascular Hook



TG-REF:448
Size/Tip:
3 1/4", 2 sharp prongs,
18.0mm spread

Millard hook





TG-REF:450
Size/Tip:
4 5/8", straight shaft,
push-pull model
Titanium
Size/Tip:
4 1/2", angled shaft,
10.0mm from bend to tip,
Size/Tip:
push-pull model
4 5/8", straight shaft,
clover leaf

**Kuglen Iris Hook &
Lens Manipulator**



TG-REF:451
Size / Tip:
4 3/4",
angled shaft,
10.0mm from bend to tip,
0.18mm diameter tip

D&K Sinskey Hook



TG-REF:452
Size/Tip:
4 3/4" double-ended,
angled 0.6mm wide x 10.0mm
long cylindrical spatula,
blunt tip,
angled 0.7mm
long hook tip

**Machet LASIK
retreatment spatula**



TG-REF:453
Size/Tip:
4 1/2", straight shaft,
0.25mm diameter blunt tip
Size/Tip:
4 3/8", angled shaft,
10.0mm from bend to tip,
0.25mm diameter blunt tip

**Sinskey Lens
Manipulating Hook**



TG-REF:454
Size/Tip:
4 1/2", Straight shaft,
0.2mm diameter blunt tip
Size/Tip:
4 3/8", angled shaft, 10.0mm
from bend to tip,
0.2mm diameter blunt tip

**Sinskey II lens
manipulating hook**



TG-REF:455
Size/Tip:
4 3/8", angled shaft,
12.0mm from bend to tip,
0.2mm diameter angled-up tip

**Reversed Sinskey
DSAEK hook**





TG-REF:456
Size/Tip:
4 5/8", straight shaft,
push-pull model
Size/Tip:
4 1/2", angled shaft,
10.0mm from bend to tip,
push-pull model
4 5/8", straight shaft,
clover leaf

Kuglen Iris Hook & Lens Manipulator



TG-REF:457
Size / Tip:
5 1/2", 11.5mm long angled
right & Left tip, with groove,

Wright Grooved Hook



TG-REF:458
Size/Tip:
4 3/4", angled, standard hooks,
serrated TC platforms

Lalonde Skin Hook Forceps



TG-REF:459
Size/Tip:
6", angled, standard hooks,
TC dusted platforms

Lalonde Skin Hook Forceps



TG-REF:460
Size/Tip:
8", 1 blunt prong,
3.0mm wide,
round handle, titanium

Adson Dura Nerve Hook



TG-REF:461
Size/Tip:
straight shaft, angled 90°,
blunt tip, round handle, titanium

Dandy Nerve Hook





TG-REF:462

Size/Tip:
7 1/4", 2.0mm wide,
blunt tip
Size/Tip:
7 1/4", 3.0mm wide,
ball tip
Size/Tip:
7 1/4", 3.0mm wide,
blunt tip

Malis Nerve Hooks
Round Handle, Titanium



TG-REF:463

Size / Tip:
9", 1 sharp hook
Size / Tip:
9", 1 blunt hook

Yasargil Micro Hook



TG-REF:464

Size/Tip:
9", angled 90°,
2.0mm ball tip,

Murphy Nerve Hook



TG-REF:465

Size/Tip:
6", #1, #2, #3 #4,
right handed

Mueller Phlebectomy
Hook, Set of 4



TG-REF:466

Size/Tip:
6", 2 prongs,
13.0mm spread,
with ball ends

Tebbetts-style
self-retaining skin hook



TG-REF:467

Size/Tip:
6", 2 sharp prongs,
5.0mm spread

Tebbetts-style
self-retaining skin hook



TAHIR GROUP OF INDUSTRIES



+92-300-6669737



TAHIR GROUP OF INDUSTRIES



TGIND.COM



TAHIR GROUP OF INDUSTRIES



tgindsale@gmail.com



TG-REF:468
Size/Tip:
8 1/4", narrow crypt hook,
Size/Tip:
8 1/4", short crypt hook
Size/Tip:
8 1/4", long crypt hook

Malis Nerve Hooks
Round Handle, Titanium



TG-REF:469
Size / Tip:
7 3/8"

Ritleng Retrieving Hook



TG-REF:470
Size/Tip:
5 5/8"

Crawford Retrieving Hook



TG-REF:471
Size/Tip:
4 3/4", double-ended,
angled reverse
Terry-Sinskey hook,
angled textured paddle

Sales DSAEK
Stripper Paddle



TG-REF:472
Size/Tip:
, angled 90°,
1 blunt prong,
4.0mm wide
Size/Tip:
, angled 90°,
1 blunt prong,
4.0mm wide

Adson Nerve Hook, 8"



TG-REF:473
Size/Tip:
9 13.0mm diameter, blunt tip
5.0mm diameter, blunt tip,
graduated lines,

Hook Probe Triangular handle





TG-REF:474
Size/Tip:

6", double-ended,
3 sharp prongs
6 3/8", double-ended,
3 sharp prongs

**Baby Senn-Miller Finger
Retractor**



TG-REF:475
Size / Tip:

6", double-ended,
3 blunt prongs
6 3/8", double-ended,
3 blunt prongs

**Baby Senn-Miller Finger
Retractor**



TG-REF:476
Size / Tip:

6 1/4", double-ended,
3 sharp prongs,
flat handle, insulated

**Senn-Miller Finger
Retractor**



TG-REF:477
Size / Tip:

6 1/4", double-ended,
3 Blunt prongs,
flat handle, insulated

**Senn-Miller Finger
Retractor**



TG-REF:478
Size/Tip:

6 3/8", double-ended,
3 sharp prongs
Titanium Blue

**Senn-Miller Finger
Retractor**



TG-REF:479
Size/Tip:

6 3/8", double-ended,
3 Blunt prongs

**Senn-Miller Finger
Retractor**



TAHIR GROUP OF INDUSTRIES



+92-300-6669737



TAHIR GROUP OF INDUSTRIES



TGIND.COM



TAHIR GROUP OF INDUSTRIES



tgindsale@gmail.com



TG-REF:480
Size/Tip:

6 1/4", double-ended,
2.5mm x 8.0mm and
5.0mm x 15.0mm wide blades
6 1/4", double-ended,
3.0mm x 9.0mm and
5.0mm x 17.0mm wide blades

Ragnell Retractor



TG-REF:481

Size / Tip:
6mm Wide X 20mm Deep,
Overall Length 140mm

Senn Green Retractor



TG-REF:482

Size / Tip:
6", double-ended,
6.0mm x 17.0mm and
9.0mm x 20.0mm blades

Davis Retractor



TG-REF:483

Size
7.125" (18.1cm)
8.25" (21cm)
, 9" (23cm)

**Lonescu Double-Ended
Leaflet Valve Retractor**



TG-REF:484

Size/Tip:
7-1/2" (193mm),
Double-Ended, 1-5/8"
(40mm) Wide and
1-1/4" (32mm)

**Goelet Retractor
Double Ended**



TG-REF:485

Size/Tip:
20x15 / 20x9
8"

**Double Ended
Retractor**





TG-REF:486
Size / Tip:
31x20/30x18
28x19/26x1
5 7/8"

Mayo-Collin Retractor Set



TG-REF:487
Blade Size (mm)
double-ended,
5.0mm and 13.0mm blades
8.0mm and 11.0mm blades
6.0mm and 9.0mm blades,

Leur Tracheal Retractor



TG-REF:488
Size / Tip:
4 1/4", #1, double-ended, 1/8" x 7/16"
and 1/4" x 13/16" blades
4 1/4", #2, double-ended, 1/4" x 1/2"
and 3/8" x 7/8" blades
4 1/4", #1, double-ended, 1/8" x 7/16"
and 1/4" x 13/16" blades

Crile Retractor



TG-REF:489
Size
4 1/2" double-ended, delicate
25.0mm x 10.0mm and
32.0mm x 13.0mm blades

Farabeuf Retractor Set



TG-REF:490
Size/Tip:
7-1/2" (193mm),
Double-Ended, 1-5/8"
(40mm) Wide and
1-1/4" (32mm)

**Jackson Tracheal
Retractor**



TG-REF:491
Size/Tip:
6 1/4", left, sharp
6 1/4", right, sharp

Bose Tracheal Retractor





TG-REF:492
Size / Tip:
5 1/2", double-ended,

**Children's Hospital
Retractor**



TG-REF:493
Size / Tip:
6 5/8"
double-ended
wide blades
large, 1" x 1 5/8"
small, 3/4" x 1"
medium, 7/8" x 1 5/8"

Roux Retractors Set Of 3



TG-REF:494
Size/Tip:
6", double-ended,
flat handle

Parker-Mott Retractor Set



TG-REF:495
Size/Tip:
6 1/4", double-ended

Parker-Tommy Retractor



TG-REF:496
Size/Tip:
6 1/4",
double-ended
3 sharp prong:
3 blunt prongs
8.0mm wide

Mathieu Finger Retractor



TG-REF:497
Size/Tip:
20 cm 26x46 mm/13x46 mm
26x45 mm/13x45 mm

Mathieu Retractor Set





TG-REF:498
Size / Tip:
8 1/4", double-ended

Army-Navy Retractor Set



TG-REF:499
Size / Tip:
9", 10.0mm wide blade,
flat 2-hole handle

Hohmann Retractor



TG-REF:500
Size/Tip:
5 1/2", angled, 19.0mm
x 45.0mm blade

Smillie Knee Retractor

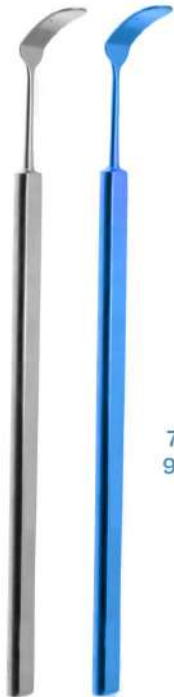

TG-REF:501
Size/Tip:
4 3/4",
thin curved
7.0mm wide blade
9.0mm wide blade
11.0mm wide

**Helveston inBarbie''
Tissue Retractor**



TG-REF:502
Size/Tip:
38 x 18 mm
20,5 cm

**Buchs Cheek
Soft Tissue Retractor**



TG-REF:503
Size/Tip:
140 mm 27 cm

**Polloson Retractor
Fenestrated**



TG-REF:504
Size / Tip:
11 3/4", double-ended

CRILE Hook and Dissector



TG-REF:505
Size / Tip:
Blunt 4 Prongs
Blade 5x11mm
6 7/8"

Klap Tendon Hook



TG-REF:506
Size/Tip:
6 1/4"
10x3mm blade

Cushing Vein Retractor



TG-REF:507
Size/Tip:
6 3/4", 13.0mm
x 13.0mm blade

Koenig Retractor



TG-REF:508

Tip / End:	Blade	Size
Sharp Prong 1	-	6 1/2"
Sharp Prong 2	7.5x7.5	6 1/2"
Sharp Prong 3	7.5x10.0	6 1/2"
Sharp Prong 4	7.5x14.0	6 1/2"
Blunt Prong 1		6 1/2"
Blunt Prong 2	6.8x7.5	6 1/2"
Blunt Prong 3	6.8x10.0	6 1/2"
Blunt Prong 4	6.8x14.0	6 1/2"

Hook Large Curved



TG-REF:509

Tip / End:	Blade	Size
Sharp Prong 1	-	6 1/2"
Sharp Prong 2	5.0x4.2	6 1/2"
Sharp Prong 3	5.0x7.0	6 1/2"
Sharp Prong 4	5.0x9.0	6 1/2"
Blunt Prong 1		6 1/2"
Blunt Prong 2	4.5x4.2	6 1/2"
Blunt Prong 3	4.5x7.0	6 1/2"
Blunt Prong 4	4.5x9.0	6 1/2"

Hook Small Curved





TG-REF:510
Blade: 10x10mm
Size: 6 7/8"

Cushing Kocher Retractor



Gil Vernet Retractor Malleable

TG-REF:511
Size / Tip:
14mm 12 1/2"
14mm 14"
14mm 16"



Ollier Retractor

TG-REF:512
Blade Size / Tip:
25mm 7 7/8"



Lahey Goiter Retractor

TG-REF:513
Blade Size / Tip:
24x8mm 7 7/8"



Meyerding Thumb Retractor



TG-REF:514

Blade:	End:	Size
A 1	18X7mm	7"
B 2	16x5mm	7"
C 3	7x4mm	7"
D 4	5x10mm	7"
E 5	11x4mm	7"
F 6	6x4mm	7"



Lahey Thyroid Retractor

TG-REF:515
Blade Size / Tip:
6mmx28mm 7 3/4"



TAHIR GROUP OF INDUSTRIES



+92-300-6669737



TAHIR GROUP OF INDUSTRIES



TGIND.COM



TAHIR GROUP OF INDUSTRIES



tgindsale@gmail.com



TG-REF:0510

Tip:	End:	Blade	Size
Sharp	1 Prong	..	8 3/4"
Blunt	1 Prong	..	8 3/4"
Sharp	2 Prong	9x8	8 3/4"
Sharp	3 Prong	9x13	8 3/4"
Sharp	4 Prong	9x19	8 3/4"
Sharp	6 Prong	9x29	8 3/4"
Sharp	8 Prong	9x40	8 3/4"
Semi S	2 Prong	8.5x8	8 3/4"
Semi S	3 Prong	8.5x13	8 3/4"
Semi S	4 Prong	8.5x19	8 3/4"
Semi S	6 Prong	8.5x29	8 3/4"
Semi S	8 Prong	8.5x40	8 3/4"
Blunt	2 Prong	8x8	8 3/4"
Blunt	3 Prong	8x13	8 3/4"
Blunt	4 Prong	8x19	8 3/4"
Blunt	6 Prong	8x29	8 3/4"
Blunt	8 Prong	8x40	8 3/4"

Volkman Retractors, Small



TG-REF:0512

Tip:	End:	Blade mm	Size
Sharp	2 Prong	20x11	8 3/4"
Sharp	3 Prong	20x18	8 3/4"
Sharp	4 Prong	20x26	8 3/4"
Sharp	6 Prong	20x40	8 3/4"
Blunt	2 Prong	20x11	8 3/4"
Blunt	3 Prong	20x18	8 3/4"
Blunt	4 Prong	20x26	8 3/4"
Blunt	6 Prong	20x40	8 3/4"

Volkman Retractors US



TG-REF:0513

Blade:	End:	Size
Semi S	8 Prongs	9 1/2"
Blunt	8 Prongs	9 1/2"

Koerte Retractors



TG-REF:0514

Tip: End: Blade S: L:
Blunt/4Prong/46x40mm/ 7 1/2"

Isreal Retractors (T Handle)



TG-REF:0515

Tip:	End:	Size:
Sharp / 3Prong		17 3/4"
Sharp / 4Prong		17 3/4"
Blunt / 4Prong		17 3/4"

Murphy Retractors (T Handle)





TG-REF:521
Blade End: Blade mm Size
Semi S 8 Prongs 28x40 11"

Koerte Wagner Retractors



TG-REF:522
Blade mm Size in
30X10 9"
40X10 9"
43X13 9"

Langenbeck Retractor



TG-REF:523
Blade mm Size in
25x6 8 1/2"
35x8 8 1/2"
35x11 8 1/2"
13x15 8 1/2"
41x15 8 1/2"
55x11 8 1/2"
70x14 8 1/2"
80x12 8 1/2"
80x16 8 1/2"

Kocher Langenbeck Retractor



TG-REF:524
Blade mm Size in
46x16 8 7/8"
55x22 8 7/8"
72x19 8 7/8"

Murphy Retractors (T Handle)



TG-REF:525

Tip	Blade End	Blademm	Size in
Blunt	4 Prongs	39x40	8 7/8"
Blunt	5 Prongs	47x51	8 7/8"
Blunt	6 Prongs	53x62	8 7/8"
Blunt	6 Prongs	70x70	8 7/8"

Isreal Retractors



TG-REF:526

Blade mm	Size in
24X8	7 7/8"

Lahey Goiter Retractors



TG-REF:527

Blade mm	Size in
40x12	8 1/4"
55x14	8 1/4"

Dockhorn Retractor



TG-REF:528

Blade mm	Size in
20x10	7 1/2"

McBurney Thyroid Retractor



TG-REF:529
Blade mm Size in
15X15 8 3/4"
20X22 8 1/3"
28X28 9 1/4"

Middeldorf Retractor



TG-REF:530
Blade mm Size in
28X22 8 7/8"

Greene Retractors



TG-REF:531
Blade mm Size in
100x30 9 3/4"
220x40 9 3/4"

Hoesel Retractor



TG-REF:532
Blade mm Size in
80x42 9 3/4"
80x50 9 3/4"
80x60 9 3/4"

Kocher Retractor



TG-REF:533
Blade mm Size in
66x10 8 1/4"

Kraemer Retractor



TG-REF:534
Tip Size in
SM 9 3/4"
LRG 9 3/4"

Richardson Eastman Retractors



TG-REF:535

Blade mm	Blade in	Length
23x20	1 x 3/4"	9 1/2"
30x29	1 1/4 x 1	1/8" 9 1/2"
37x37	1 1/2 x 1	1/2" 9 1/2"
47x20	2 x 3/4"	9 1/2"

Richardson Retractor



TG-REF:536

Blade mm	Blade in	Length
50x40	2 x 1/2"	10 1/4"
64x4	2 1/2 x 2"	10 1/4"
70x65	2 3/4 x 2 1/2"	10 1/4"
90x76	3 1/2 x 3"	10 1/4"

Kelly Retractor



TG-REF:537
Blade Sizemm Lengthin
130x38 10 1/4"

Sauerbruch Retractor



TG-REF:538
Blade Sizemm Blade End Lengthin
123 x45 Flex 11 5/8"
123 x64 Flex 11 5/8"
190X115 Flex 12 1/2"

Harrington Lung Retractor



TG-REF:539
Blade Sizemm Blade End Lengthin
195 x115 Flex 14 3/8"

Richardson Retractor



TG-REF:540
Blade Sizemm Lengthin
36x8 9 1/2"
60x12 10"
75x12 10 5/8"
120x12 11 12"

Zenker Retractors



TG-REF:541
Blade Sizemm Lengthin
130x38 10 1/4"

Deaver Retractor Flat Handle



TG-REF:542
Blade Sizemm Lengthin
25 1 12 1/4 "
38 1 1/2 12 1/4 "
50 2 12 "
75 3 12 1/4 "

Deaver Retractor Hollow Handle



TG-REF:543
Blade Sizemm Lengthin
75 3 12 1/2 "

Deaver Retractor Hollow Handle



TG-REF:544
Blade Sizemm Lengthin
25 1 9 1/4 "

Deaver Retractor Double Ended





TG-REF:545

Blade	Size	Length
Malleable	10	6 1/4 "
Malleable	13	7 "
Rigid	10	7 1/8 "
Rigid	13	7 1/8 "

Hasson "S" Retractors



TG-REF:546

Size	Length
47X57 / 93X157	9 "

Weinberg Vagotomy Retractor



TG-REF:547

Size	Length
53X80	9 3/4 "
72X82	10 1/4 "

Doyen Abdominal Retractors



TG-REF:548

Blade	Length
25mm	9 1/4 "

Mueller Retractor



TAHIR GROUP OF INDUSTRIES



+92-300-6669737



TAHIR GROUP OF INDUSTRIES



TGIND.COM



TAHIR GROUP OF INDUSTRIES



tgindsale@gmail.com



Blade Size	Length
124x60	11 1/2
174x60	13

Marks Pelvis Retractor



Blade Size	Length
178x60	13

Marks Pelvis Retractor (Continued)



Blade Size	Length
2 1/2" wide	14 1/2" long

Deaver Retractor Hollow Grip Handle



Blade Size	Length
1/25 mm,	12-1/4" 31 cm,
with fiber optic light guide	

Deaver Grip Retractor



TAHIR GROUP OF INDUSTRIES



+92-300-6669737



TAHIR GROUP OF INDUSTRIES



TGIND.COM



TAHIR GROUP OF INDUSTRIES



tgindsale@gmail.com



TG-REF:553
Blade mm in Length in
45mmx63mm 11 1/4"

Reverdin Spatula



TG-REF:554
Blade Size mm Blade Size in Length in
40/50 1 1/2 12"

Haberer Malleable Spatula



TG-REF:555
Blade Size mm Blade Size in Length in
17/25 3/4 7 7/8"

Tuffier Spatula Malleable

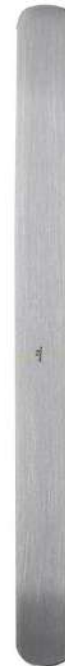

TG-REF:556

Blade mm	Blade Size	in Length in
5	1/8	8"
12	1/2	7 7/8"
17	3/4	7 7/8"
25	1	8"
25	1	9 3/4"
75	3	13"
20	3/4	13"
25	1	13"
30	1 1/4	13"
40	1 1/2	13"
50	1 1/2	13"
65	2 1/2	13"
100	4	13"

Ribbon Spatula Malleable



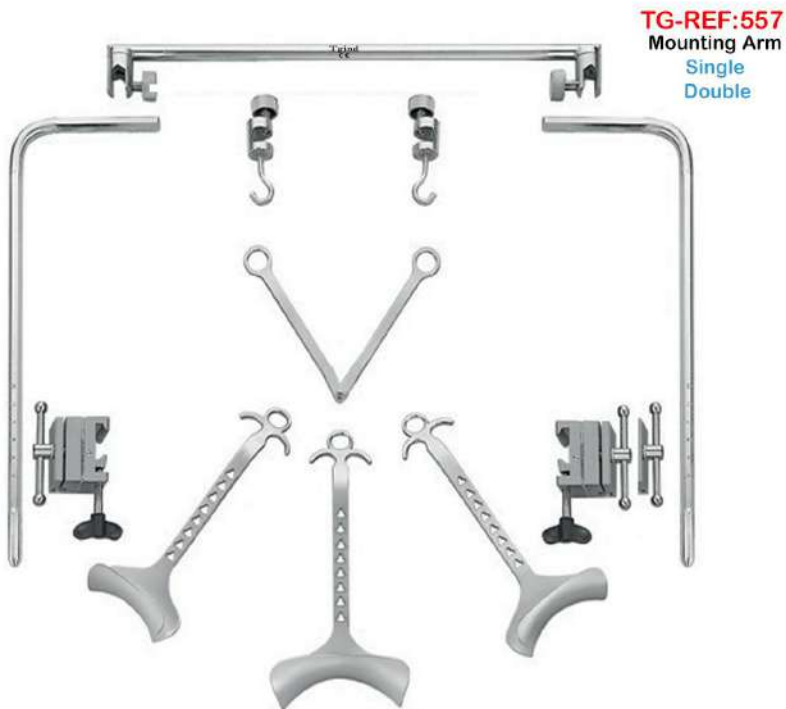

Rocharad Retractor Mounting Frame



Mayo Collin Appendectomy Retractor

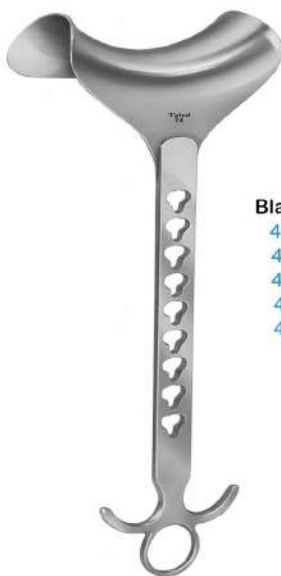

Rocharad Blade



Rocharad Fixation Device



TG-REF:561
Blade Size
20x25mm

Hertzler Abdominal Retractor



TG-REF:562
Blade Blade
55mm
38mm

Gosset Abdominal Retractor Small



TG-REF:563
Description
Set Complete
Spreader Only
Lateral Blade Pair 37 x62mm

Collin Abdominal Retarctor



TG-REF:564

Description	Lateral Blade
Balfour Retractor 200X155mm	60mm
Balfour Retractor 200X235mm	60mm
Balfour Retractor 200X265mm	90mm
Center Blade 47x80mm	
Center Blade 62x76mm	
Center Blade 80x80mm	

Balfour Abdominal Retarctor





TG-REF:561
Description
Center Blade 21x24mm



TG-REF:562
Description
Pair, 2 1/2" (64mm) Deep
Pair, 3 1/2" (89mm) Deep
Pair, 4" (102mm) Deep

Balfour Baby Abdominal Retarctor

**Balfour Side Blade
Solid F/Retractor**



TG-REF:563
Description
Pair, 2 1/2" (64mm) Deep
Pair, 3 1/2" (89mm) Deep
Pair, 4" (102mm) Deep



TG-REF:564
Blade Blademm
Malleable 171x51
Malleable 267x57

**Balfour Side Blade
Wire F/Retractor**

Dixon Blade Center



TAHIR GROUP OF INDUSTRIES



+92-300-6669737



TAHIR GROUP OF INDUSTRIES



TGIND.COM



TAHIR GROUP OF INDUSTRIES



tgindsale@gmail.com

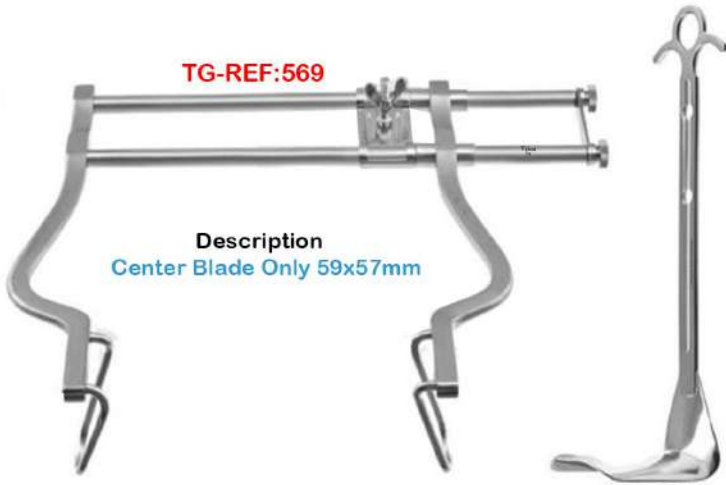

Gosset Abdominal Retractor Large



Balfour Abdominal Retractor Blade



Center Blade



Dixon Blade Center

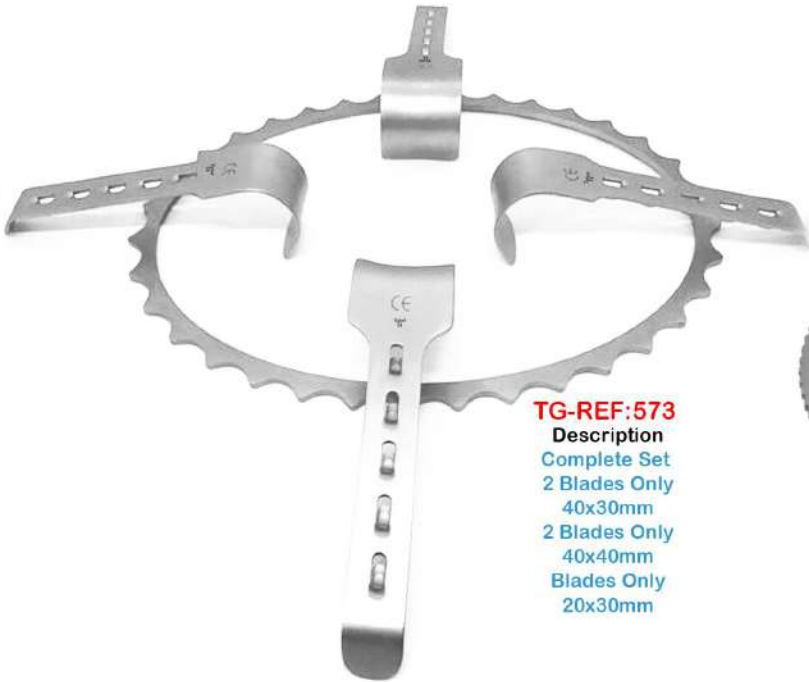

TG-REF:573
Description
Complete Set
2 Blades Only
40x30mm
2 Blades Only
40x40mm
Blades Only
20x30mm

TG-REF:574

Size	Width x Length (in)
Small	8 1/2 x 12"
Medium	10 1/2 x 15"
Large	12 1/2 x 18 1/2"



Denis-Browne Abdominal Retractor

Bookwalter-Style oval ring retractor, small,



TG-REF:575

Description

- Complete Set
- Segmented Medium Oval Ring
- Large Oval Ring
- Standrad Table Clamp 18"
- Horizontal Flex Bar W/ 360 Rotation 19 1/4"
- Horizontal Fixed Bar 15 1/2"
- Post Clamp For 1" Bar
- Non-Tilting Blade Clamp (2 each)
- Tilting Blade Clamp (6 each)
- Kelly Retractor Blade 2"x3" (2 each)
- Kelly Retractor Blade 2"x4"
- Kelly Retractor Blade 2"x5"
- Kelly Retractor Blade 2"x6"
- Malleable Blade 1 1/2"x 6"
- Malleable Retractor Blade 2"x 6"
- Malleable Retractor Blade 3"x 6"
- Balfour Bladder Blade 3" x 2 1/2"
- Harrington Sweetheart Blade 2 1/2" x 5"
- Gelpi Point Retractor Blade

Bookwalter Ring Retractor Box Set



TAHIR GROUP OF INDUSTRIES



+92-300-6669737



TAHIR GROUP OF INDUSTRIES



TGIND.COM



TAHIR GROUP OF INDUSTRIES



tgindsale@gmail.com



TG-REF:576

Size	Description	Width x Length
Small	Removable 4" Segments	8 1/2" x 14"
Medium	Removable 8" Segments	10 1/2" x 19 1/2"
Large	Removable 6" Segments	12 1/2" x 19 1/2"
X Large	Removable 6" Segments	16" x 22"



TG-REF:577

Size	Dimensions
Small Half Circle	Ø8 1/2", 21.3cm
Medium Half Circle	Ø10 1/2", 26.3cm
Large Half Circle	Ø12 1/2", 31.3cm

Bookwalter-Style Oval Segmented Ring

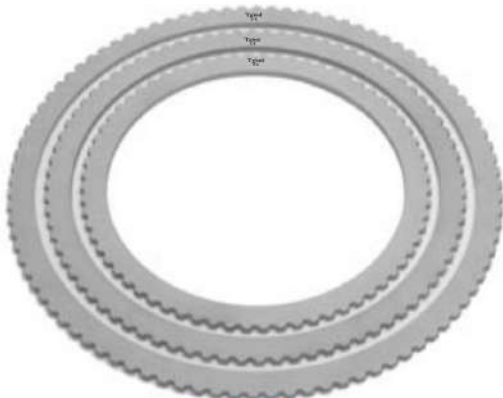

TG-REF:578

Size	Dimensions
Small Round Ring	Ø8 1/2", 21.3cm
Medium Round Ring	Ø10 1/2", 26.3cm
Large Round Ring	Ø12 1/2", 31.3cm

Round Ring

Segmented Round Ring

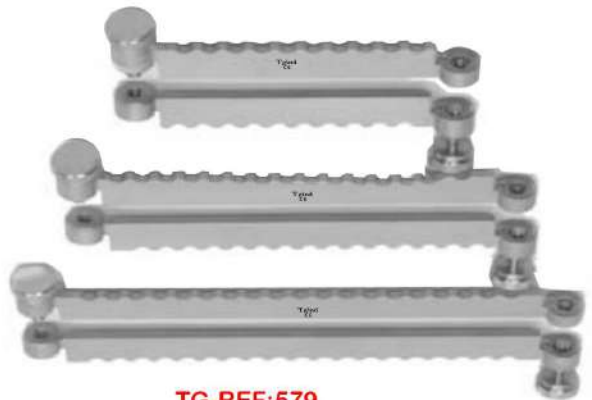

TG-REF:579

Size	Dimensions
Large Straight Segment	8", 20cm
Medium Straight Segment	6", 15cm
Small Straight Segment	4", 10cm

Segments For Oval Ring Pair





TG-REF:580
Size
14" x 15", 35cm x 37.5cm

Segmented Elliptical Ring



TG-REF:581
Size
9½" x 14½", 23.8cm x 36.3cm

Segmented Perineal Ring Notched



TG-REF:582
Size
12", 30cm

IMA Cross Bar

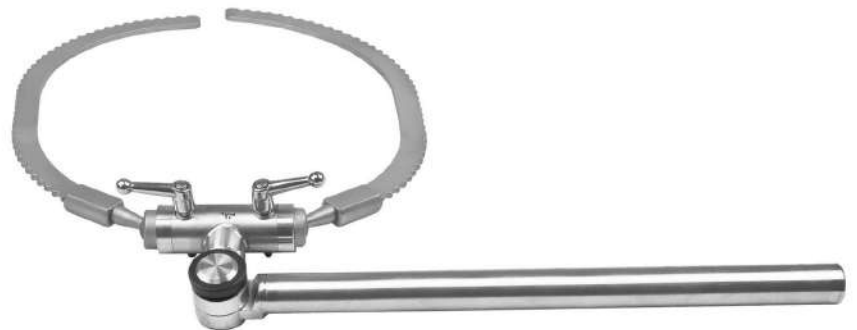

TG-REF:583
Size
Integrated Horizontal Bar Ring
measures 10½" x 14"
(26.3cm x 35cm) in closed position.

**Split Ring Frame with Integrated
Horizontal Bar Ring**





TG-REF:584
Standard Ratchet



TG-REF:585
Tilt Ratchet



TG-REF:586
Tilt & Swivel Clamp



TG-REF:587
Non-Tilt Blade Clamp





TG-REF:588
Post Clamp

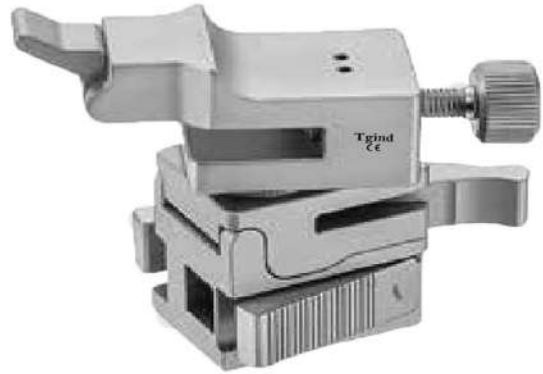

TG-REF:589
Multi Directional Blade Clamp



TG-REF:590
Twist Ratchet Adapter



TG-REF:591
IMA Ratchet





Working Length	Total Length
11 1/2"	18"
17"	24"

TG-REF:592
Flat Table Clamp



Lengthin
15 1/2
22

TG-REF:593
**Adaptor For Attaching
Handheld Retractor**



Lengthin
12"
14"

TG-REF:594
Vertical Extension Bar



Lengthin
15 1/2"
22"

TG-REF:595
Horizontal Fixed Bar



TAHIR GROUP OF INDUSTRIES



+92-300-6669737



TAHIR GROUP OF INDUSTRIES



TGIND.COM



TAHIR GROUP OF INDUSTRIES



tgindsale@gmail.com



TG-REF:597
BALFOUR BLADES
Description/Size
72018 3" x 258", 6.5cm x 7.5cm
72038 3½" x 2¼", 8.8cm x 6.9cm



TG-REF:598
BIG BOY BLADES
Ref. No. Description/Size
2" x 6½", 5cm x 16.3cm
3" x 6½", 7.5cm x 16.3cm



TG-REF:599
DEAVER BLADES
Description/Size
23" x 2¼", 1.7cm x 5.7cm
1" x 3½", 2.5cm x 8.8cm
1" x 5", 2.5cm x 12.5cm
3" x 10", 7.5cm x 25cm



TG-REF:600
FENCE BLADES
Description/Size
4" x 5", 10cm x 12.5cm
4" x 5" Overall, 10cm x 12.5cm
Each Malleable Finger is
38" x 5", .9cm x 12.5cm



TG-REF:601
GELPI HOOK



TG-REF:602
IMA HOOK



HARRINGTON BLADES ALSO CALLED "SWEETHEARTS"



TG-REF:603
Description/Size
1" x 55/8" x 2 1/2"
2.5 x 14 x 6.3cm



TG-REF:604
Description/Size
1/2" x 2 1/2" x 2"
1.3 x 6.3 x 5cm



TG-REF:605
Description/Size
2 1/2" x 55/8" x 3 1/2"
6.3 x 14 x 8.8cm



TG-REF:606
Description/Size
2 1/2" x 8" x 3 1/2"
6.3 x 20 x 8.8cm



TG-REF:607
Description/Size
3 1/2" x 10" x 4 1/2"
8.8 x 25 x 11.3cm

MEYERDING BLADES



TG-REF:608
Description/Size
2 3/8" x 2 1/3"
1.7cm x 5.8cm
Without Teeth



TG-REF:609
Description/Size
1" x 3 1/3"
2.5cm x 8.3cm
With Teeth



TG-REF:610
Description/Size
2 3/8" x 2 1/3"
1.7cm x 5.8cm
With Teeth

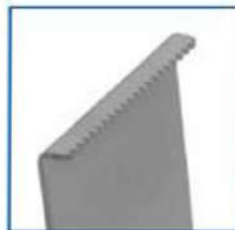

TG-REF:611
Description/Size
2" x 3 3/4"
5cm x 9.4cm
With Teeth



SCOVILLE HOOKS

TG-REF:612
Description/Size
Small
2", 5cm Depth



TG-REF:613
Description/Size
Large
3", 7.5cm Depth



KELLY RETRACTOR BLADES

TG-REF:614
Description/Size
1" x 1½"
2.5cm x 3.8cm



TG-REF:615
Description/Size
1" x 2½"
2.5cm x 6.3cm



TG-REF:616
Description/Size
1" x 3"
2.5cm x 7.5cm



TG-REF:617
Description/Size
2" x 1½"
5cm x 3.8cm



TG-REF:618
Description/Size
2" x 2"
5cm x 5cm



TG-REF:619
Description/Size
2" x 2½"
5cm x 6.3cm



TG-REF:620
Description/Size
2" x 3"
5cm x 7.5cm



TG-REF:621
Description/Size
2" x 3"
5cm x 7.5cm



TG-REF:622
Description/Size
2" x 4"
5cm x 10cm



TG-REF:623
Description/Size
2" x 5"
5cm x 12.5cm



TG-REF:624
Description/Size
2" x 6"
5cm x 15cm



TG-REF:625
Description/Size
2½" x 3"
6.3cm x 7.5cm



PROTECTED EDGE MALLEABLE RETRACTOR BLADES

TG-REF:626
Description/Size
1/2" x 4", 1.3cm x 10cm



TG-REF:628
Description/Size
1" x 5", 2.5cm x 12.5



TG-REF:630
Description/Size
2" x 6", 5cm x 15cm



TG-REF:632
Description/Size
2" x 10", 5cm x 25cm



TG-REF:634
Description/Size
3" x 8", 7.5cm x 20cm



TG-REF:636
Description/Size
3" x 12", 7.5cm x 30cm



TG-REF:638
Description/Size
4" x 10", 10cm x 25cm



TG-REF:640
Description/Size
6" x 9", 15cm x 22.5cm



TG-REF:627
Description/Size
3/4" x 4", 1.9cm x 10cm



TG-REF:629
Description/Size
1 1/2" x 6", 3.8cm x 15cm



TG-REF:631
Description/Size
2" x 8", 5cm x 20cm



TG-REF:633
Description/Size
3" x 6", 7.5cm x 15cm



TG-REF:635
Description/Size
3" x 10", 7.5cm x 25cm



TG-REF:637
Description/Size
4" x 8", 10cm x 20cm



TG-REF:639
Description/Size
4" x 12", 10cm x 30cm



TG-REF:641
Description/Size
6" x 12", 15cm x 30cm

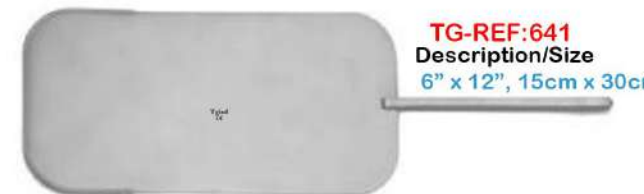

TAHIR GROUP OF INDUSTRIES



+92-300-6669737



TAHIR GROUP OF INDUSTRIES



TGIND.COM



TAHIR GROUP OF INDUSTRIES



tgindsale@gmail.com

RAKES HOOK RETRACTORS

TG-REF:642
Description/Size
3-Prong
2 3/8" x 3/4"
1.7cm x 1.9cm



TG-REF:643
Description/Size
4-Prong
3/4" x 1/3"
1.9cm x .8cm



TG-REF:644
Description/Size
6-Prong
1" x 1/3"
2.5cm x .8cm



TG-REF:645
Description/Size
3/4" x 1", 1.9cm x 2.5cm



RICHARDSON BLADES

TG-REF:646
Description/Size
3/4" x 2", 1.9cm x 5cm



TG-REF:647
Description/Size
Set of all 3
Richardson Blades



TG-REF:648
Description/Size
1" x 1 1/4", 2.5cm x 3.1cm



RECTAL BLADES

TG-REF:649
Description/Size
7/8" x 27/8"
2.2cm x 7.2cm



WILEY RENAL VEIN BLADE

TG-REF:650
Description/Size
7/8" x 37/8"
2.2cm x 9.7cm



TG-REF:651
Description/Size
1" x 7"
2.5cm x 17.5cm



VAGINAL BLADES

TG-REF:652
Description/Size
Lateral Blade
1" x 3"
2.5cm x 7.5cm



TG-REF:653
Description/Size
Posterior Blade
1" x 4 1/2"
2.5cm x 11.3cm



ST. MARKS BLADE

TG-REF:654
Description/Size
2 1/3" x 7"
5.8cm x 17.5cm



UROLOGY CARROLL BLADE

TG-REF:655
Description/Size
Malleable
1 1/2" to 3 1/4" x 7"
3.8cm to 8.1cm x 17.5cm



YU-HOLTGREW BLADE

TG-REF:656
Description/Size
2" x 6 1/8"
5cm x 15.3cm
Slot: 5/8" x 1 1/2"
1.5cm x 3.8cm



TAHIR GROUP OF INDUSTRIES



+92-300-6669737



TAHIR GROUP OF INDUSTRIES



TGIND.COM



TAHIR GROUP OF INDUSTRIES



tgindsale@gmail.com

HEAD AND NECK PROCEDURES

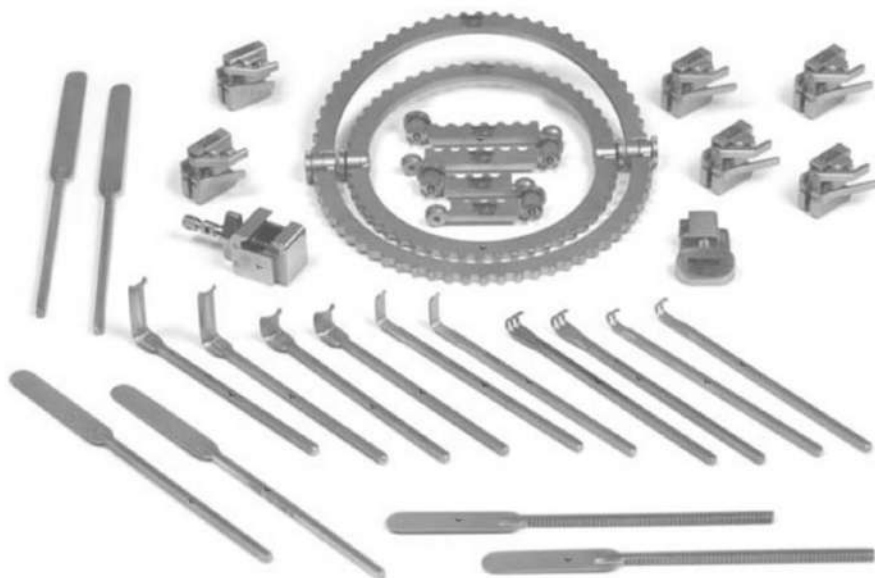

TG-REF:657
Description/Size

- X1 Mini-Clasper
- X1 Round Segments, 5"
- X1 Round Segments, 6½"
- X1 Straight Segments, 2"
- X1 Straight Segments, 3½"
- X6 Mini-Tilt Ratchets
- X1 Mini-Twist Ratchet
- X2 Blade, Kelly, 38" x 1¼"
- X2 Blade, Kelly, ½" x ½"
- X2 Blade, Malleable, ½" x 2"
- X2 Blade, Malleable, ½" x 2½"
- X2 Blade, Malleable, ½" x 4"
- X2 Blade, Senn-Miller Solid
- X2 2-Prong Hook, Blunt
- X2 3-Prong Hook, Blunt

SMALL INCISION SURGERY

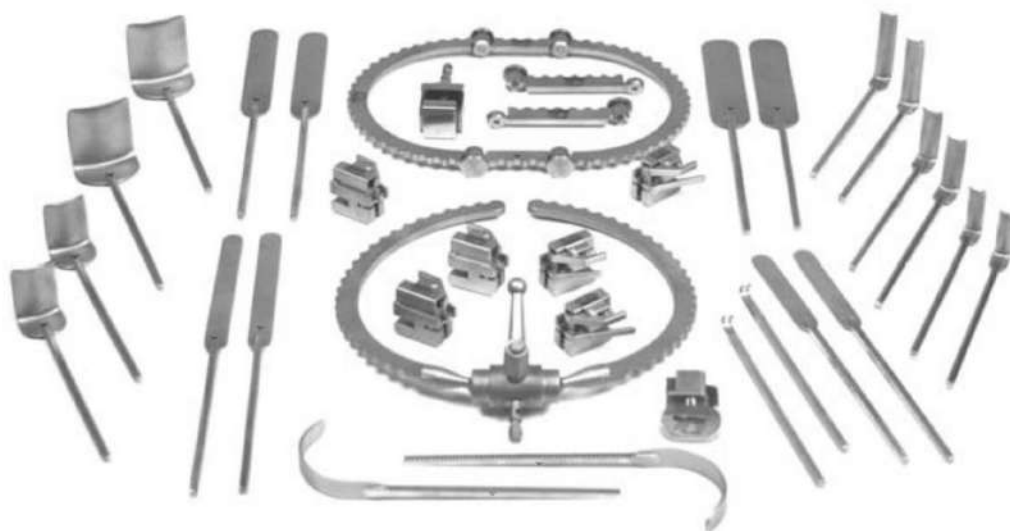

TG-REF:658
Description/Size

- x1 Mini-Clasper
- x1 Adjustable Split Ring, 7"
- x1 Seg Oval Ring, 5" x 7"
- x1 Straight Segments, 3½"
- x6 Mini-Tilt Ratchets
- x1 Mini-Twist Ratchet
- x2 Blade, Kelly, 38" x 1¼"
- x2 Blade, Kelly, ½" x 1½"
- x2 Blade, Kelly, ½" x 2"
- x2 Blade, Kelly, 1" x 1½"
- x2 Blade, Kelly, 1½" x 2"
- x2 Blade, Malleable, ½" x 2½"
- x2 Blade, Malleable, ½" x 4"
- x2 Blade, Malleable, 1" x 4"
- x2 Blade, Malleable, 1½" x 4"
- x2 2-Prong Hook, Blunt
- x2 Blade, Deaver, ½" x 2"

PERINEAL SURGERY INSTRUMENTS SET

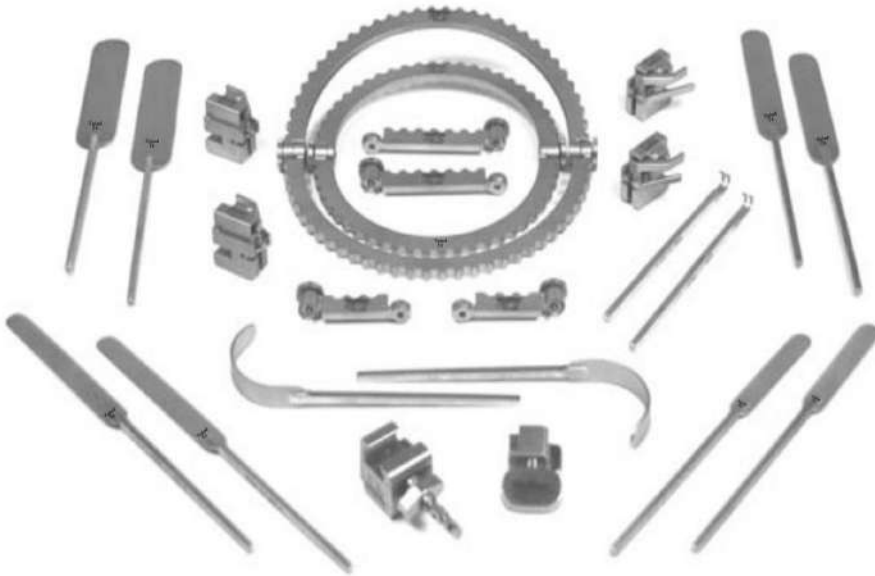

TG-REF:659

Description/Size

- x1 Mini-Clasper
- x1 Round Segments, 5"
- x1 Round Segments, 6½"
- x1 Straight Segments, 2"
- x1 Straight Segments, 3½"
- x4 Mini-Tilt Ratchets
- x1 Mini-Twist Ratchet
- x2 Blade, Malleable, ½" x 2½"
- x2 Blade, Malleable, ½" x 4"
- x2 Blade, Malleable, 1" x 4"
- x2 Blade, Malleable, 1½" x 4"
- x2 2-Prong Hook, Sharp
- x2 Blade, Deaver, ½" x 2"

HAND SURGERY INSTRUMENTS SET

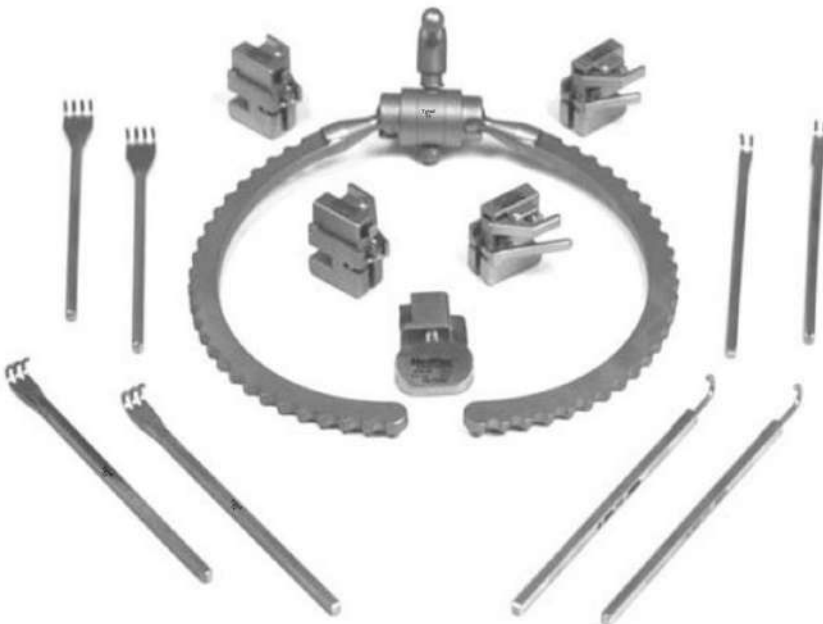

TG-REF:660

Description/Size

- x1 Adjustable Split Ring, 7"
- x4 Mini-Tilt Ratchets
- x1 Mini-Twist Ratchet
- x2 Single Hook, Sharp
- x2 Double Hook, Sharp
- x2 Triple Hook, Sharp
- x2 Quad Hook, Sharp
- x1 Adjustable Split Ring, 7"
- x4 Mini-Tilt Ratchets
- x1 Mini-Twist Ratchet
- x2 Single Hook, Blunt
- x2 Double Hook, Blunt
- x2 Triple Hook, Blunt
- x2 Quad Hook, Blunt



TAHIR GROUP OF INDUSTRIES



+92-300-6669737



TAHIR GROUP OF INDUSTRIES



TGIND.COM



TAHIR GROUP OF INDUSTRIES



tgindsale@gmail.com

BREAST SURGERY AND AXILLARY NODE DISSECTION SET

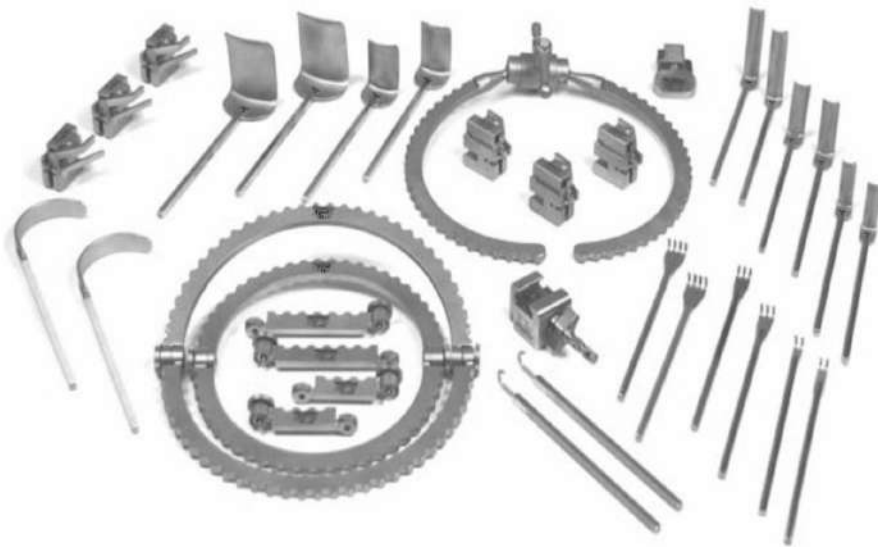

TG-REF:661

Description/Size

- x1 Adjustable Split Ring, 7"
- x1 Round Segments, 5"
- x1 Round Segments, 6½"
- x1 Straight Segments, 2"
- x1 Straight Segments, 3½"
- x1 Mini-Clasper
- x2 Blade, Kelly, 3/8" x 1¼"
- x2 Blade, Kelly, ½" x 1½"
- x2 Blade, Kelly, ½" x 2"
- x2 Blade, Kelly, 1" x 1½"
- x2 Blade, Kelly, 1½" x 2"
- x2 Blade, Deaver, ½" x 2"
- x2 Single Hook, Sharp
- x2 Double Hook, Sharp
- x2 Triple Hook, Sharp
- x2 Quad Hook, Sharp

STARTER SYSTEM FOR SMALL INCISION SURGERY INSTRUMENTS SET

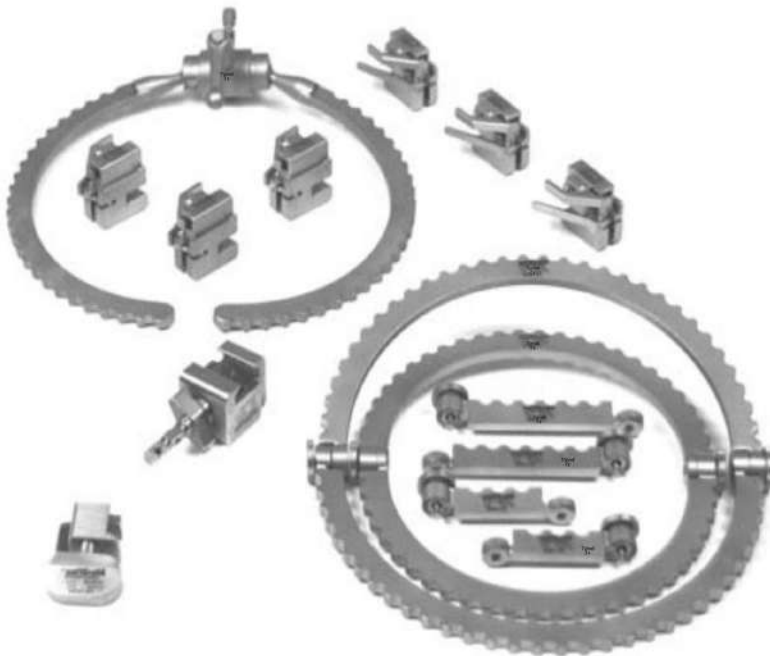

TG-REF:662

Description/Size

- x1 Mini-Clasper
- x1 Adjustable Split Ring, 7"
- x1 Round Segments, 5"
- x1 Round Segments, 6½"
- x1 Straight Segments, 2"
- x1 Straight Segments, 3½"
- x6 Mini-Tilt Ratchets
- x1 Mini-Twist Ratchet
- x6 Mini-Tilt Ratchets
- x1 Mini-Twist Ratchet



TAHIR GROUP OF INDUSTRIES



+92-300-6669737



TAHIR GROUP OF INDUSTRIES



TGIND.COM



TAHIR GROUP OF INDUSTRIES



tgindsale@gmail.com

CASPER CERVICAL RETRACTOR SET



TG-REF:663

Description/Size

- X1 Transversal Basic Cervical Retractor
- X1 Longitudinal Basic Counter Retractor
- X5 Lateral Serrated Blades
- X5 Blunt Blades
- X5 Medial Toothed Blades

Mis Retractor System Tubular Retractors With Sterilization Box Titanium Coated

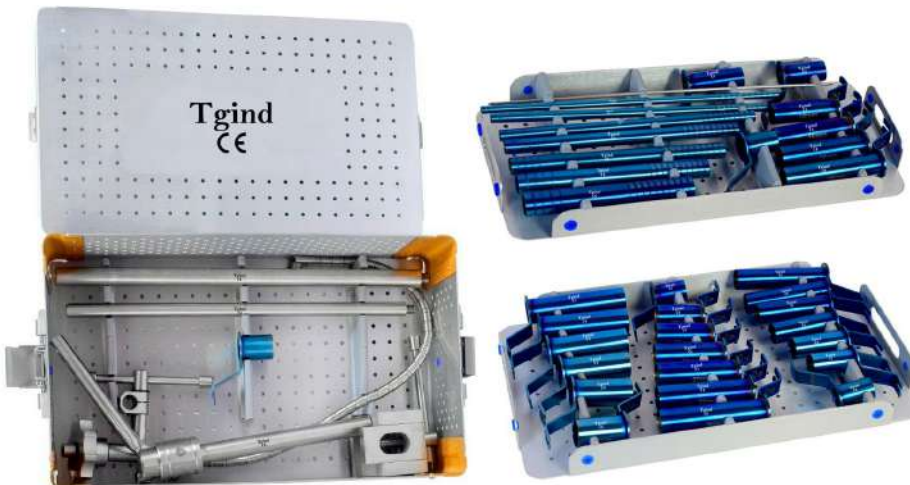

TG-REF:664

Name	Diamitor	Length
Neupsy Key	12-14 mm	30
Neupsy Key	12-14 mm	40
Neupsy Key	12-14 mm	50
Neupsy Key	12-14 mm	60
Neupsy Key	12-14 mm	70
Neupsy Key	12-14 mm	80
Neupsy Key	12-14 mm	90
Neupsy Key	14-16 mm	30
Neupsy Key	14-16 mm	40
Neupsy Key	14-16 mm	50
Neupsy Key	14-16 mm	60
Neupsy Key	14-16 mm	70
Neupsy Key	14-16 mm	80
Neupsy Key	14-16 mm	90
Neupsy Key	16-18 mm	30
Neupsy Key	16-18 mm	40
Neupsy Key	16-18 mm	50
Neupsy Key	16-18 mm	60
Neupsy Key	16-18 mm	70
Neupsy Key	16-18 mm	80
Neupsy Key	16-18 mm	90
Neupsy Key	18-20 mm	30
Neupsy Key	18-20 mm	40
Neupsy Key	18-20 mm	50
Neupsy Key	18-20 mm	60
Neupsy Key	18-20 mm	70
Neupsy Key	18-20 mm	80
Neupsy Key	18-20 mm	90
Dilators	6 mm	
Dilators	8 mm	
Dilators	10 mm	
Dilators	12 mm	
Dilators	14 mm	
Dilators	16 mm	
Dilators	18 mm	
Tubular Flexible Arm		
Table clamp Set		

Bookwalter Kit Retractor System Set Box



TG-REF:665

Description/Size

- 1 Post Coupling Balfour Retractor
- Horizontal Flex Bar
- Harrington Retractor
- Medium Oval Ring
- Segmented Ring
- Gelpi Retractor
- Malleable Retractor 2 (2"x6"51mmx152mm)
- Malleable Retractor 1 (3"x6"76mmx152mm)
- Kelly Retractors 2 (2"x3"/51mmx76mm)
- Kelly Retractors 1 (2"x4"/51mmx110mm)
- Kelly Retractors 1 (2"x5"/51mmx127mm)
- Kelly Retractors 1 (2"x6"/51mmx152mm)
- 6 Tilt Ratchet Mechanisms
- 2 Ratchet Mechanisms

Leyla Brain Retractor Neurosurgery Surgical



TG-REF:666

Description/Size

- 2 x Socket Joints
- 2 x Coupling Head
- 1 x Holding Rod
- 2 x Flexible arms with Fix Base
- 2 x Flat Spatulas with Holders



TAHIR GROUP OF INDUSTRIES



+92-300-6669737



TAHIR GROUP OF INDUSTRIES



TGIND.COM



TAHIR GROUP OF INDUSTRIES



tgindsale@gmail.com

100

Tischler Standard and Mini-Tischler Set Of 8



Up Tip - Mini Tischler

Bite Size: 4.2mm x 2.3mm
Length: 20cm/25cm



TG-REF:A-667

Up Tip - Tischler Standard

Bite Size: 7mm x 3mm
Length: 20cm



TG-REF:A-668

**Left-Angled Tip
Tischler Standard**

Bite Size: 7mm x 3mm
Length: 20cm



TG-REF:A-672

Down Tip - Mini Tischler

Bite Size: 4.2mm x 2.3mm
Length: 20cm



TG-REF:A-669

**Right-Angled Tip
Tischler Standard**

Bite Size: 4.2mm x 2.3mm
Length: 20cm



TG-REF:A-673

Down Tip - Tischler Standard

Bite Size: 7mm x 3mm
Length: 20cm



TG-REF:A-670

**Right-Angled Tip
Tischler Mini**

Bite Size: 7mm x 3mm
Length: 20cm



TG-REF:A-674

**Left-Angled Tip
Tischler Mini**

Bite Size: 4.2mm x 2.3mm
Length: 20cm



TG-REF:A-671

Tischler, Medium Standard & Extra-Long Forceps Set Of 2

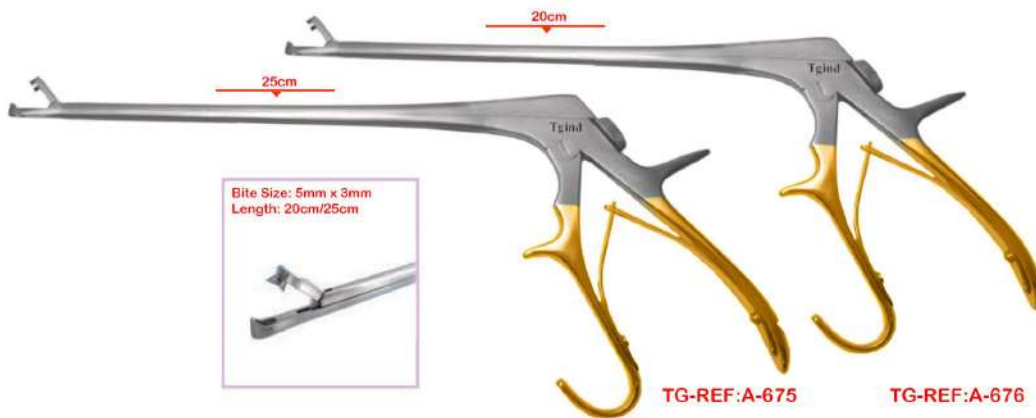

Bite Size: 5mm x 3mm
Length: 20cm/25cm



TG-REF:A-675

TG-REF:A-676



TAHIR GROUP OF INDUSTRIES



+92-300-6669737



TAHIR GROUP OF INDUSTRIES



TGIND.COM



TAHIR GROUP OF INDUSTRIES



tgindsale@gmail.com

Rainbow Kevorkian Biopsy Tischler Forceps Standard & Extra-Long



Bite Size: 9mm x 3mm
Length: 20cm/25cm

T-REF: 00160

Black/Gold Apex Biopsy Tischler Forceps Standard & Extra-Long



Bite Size: 7mm x 3mm
Length: 20cm/25cm

T-REF: 00161

T-REF: 00162

TG-REF:A-672

TG-REF:A-673

TG-REF:A-674

Rotating Biopsy Punches Forceps Standard Tip Straight & Mini Tip



Rotatable

Removable Handle

Mini-Tischler, Up

Bite Size: 4.2mm x 2.3mm
Length: 21cm



T-REF: 00163

Mini-Tischler, Down

Bite Size: 4.2mm x 2.3mm
Length: 21cm



T-REF: 00164

Tischler, Standard Down

Bite Size: 7mm x 3mm
Length: 21cm



T-REF: 00165

Tischler, Standard Up

Bite Size: 7mm x 3mm
Length: 21cm



T-REF: 00166

Kevorkian Tip Straight

Bite Size: 5mm x 3mm
Length: 21cm



T-REF: 00167

Oval Tip Straight

Bite Size: 9mm x 3mm
Length: 21cm



T-REF: 00168



TAHIR GROUP OF INDUSTRIES



+92-300-6669737



TAHIR GROUP OF INDUSTRIES



TGIND.COM



TAHIR GROUP OF INDUSTRIES



tgindsale@gmail.com

100-B

Kerrison Rongeurs

TGIND
Instruments

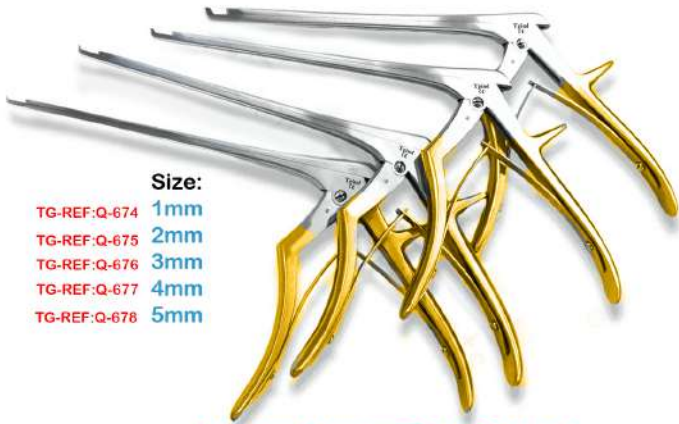

Size:
 TG-REF:Q-674 1mm
 TG-REF:Q-675 2mm
 TG-REF:Q-676 3mm
 TG-REF:Q-677 4mm
 TG-REF:Q-678 5mm

Kerrison Rongeurs Gold Coated

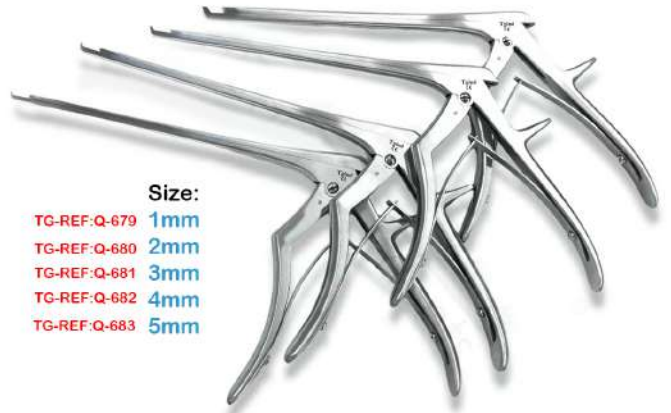

Size:
 TG-REF:Q-679 1mm
 TG-REF:Q-680 2mm
 TG-REF:Q-681 3mm
 TG-REF:Q-682 4mm
 TG-REF:Q-683 5mm

Kerrison Rongeurs 45 Degree

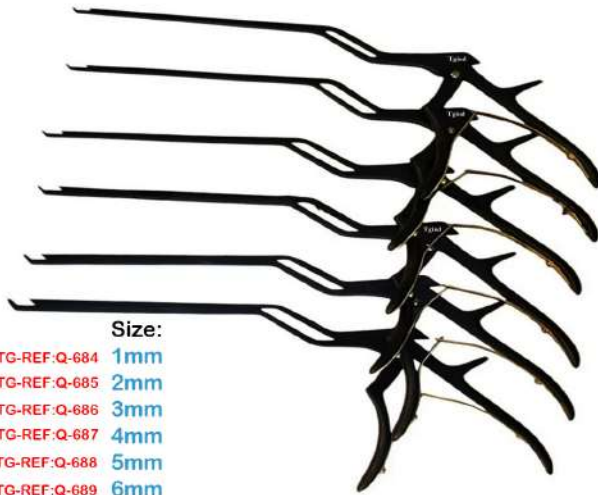

Size:
 TG-REF:Q-684 1mm
 TG-REF:Q-685 2mm
 TG-REF:Q-686 3mm
 TG-REF:Q-687 4mm
 TG-REF:Q-688 5mm
 TG-REF:Q-689 6mm

**Kerrison Rongeur Bayonet Angled
45 Degree Angled Matte Black**

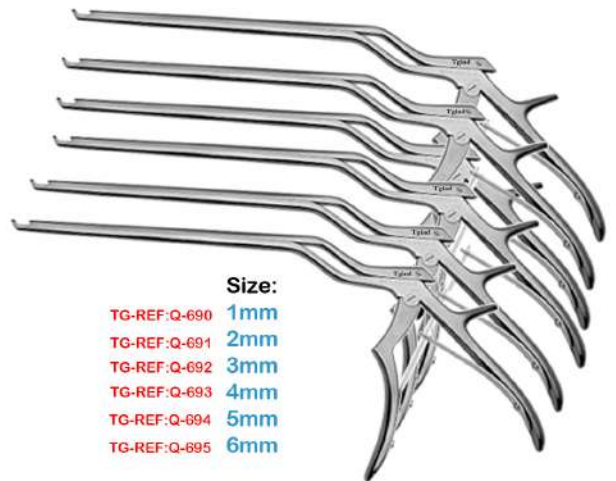

Size:
 TG-REF:Q-690 1mm
 TG-REF:Q-691 2mm
 TG-REF:Q-692 3mm
 TG-REF:Q-693 4mm
 TG-REF:Q-694 5mm
 TG-REF:Q-695 6mm

**Kerrison Rongeur Bayonet Angled
45 Degree Angled**



Size:
 TG-REF:Q-696 1mm
 TG-REF:Q-697 2mm
 TG-REF:Q-698 3mm
 TG-REF:Q-699 4mm
 TG-REF:Q-700 5mm

**Kerrison Rongeurs Double Action With Lock
Black /Gold Coated**



Size:
 TG-REF:Q-701 1mm
 TG-REF:Q-702 2mm
 TG-REF:Q-703 3mm
 TG-REF:Q-704 4mm
 TG-REF:Q-705 5mm

**Kerrison Rongeurs Double Action With Lock
Titanium Blue Gold Coated**



TAHIR GROUP OF INDUSTRIES



+92-300-6669737



TAHIR GROUP OF INDUSTRIES



TGIND.COM



TAHIR GROUP OF INDUSTRIES



tgindsale@gmail.com

100-C



TG-REF:667
Size / Tip:
3 3/8",
1x1 sharp prongs

Spring Wire Retractor



TG-REF:668
Size / Tip:
5",small, 1x1 prongs

Spring Wire Retractor

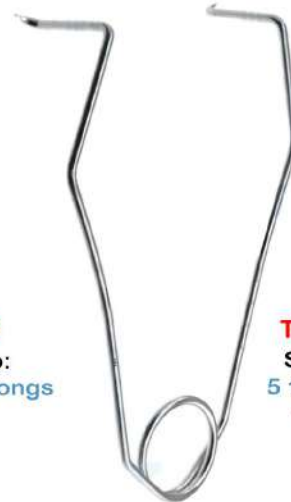

TG-REF:669
Size / Tip:
5 1/8",medium,
1x1 prongs

Spring Wire Retractor

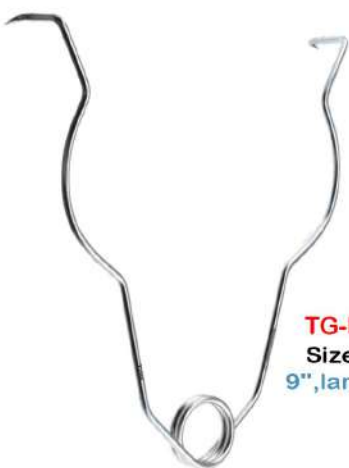

TG-REF:670
Size / Tip:
9",large prongs

Spring Wire Retractor



TG-REF:671
Size / Tip:
4 1/2",solid blades

Vascular Spring Wire Retractor



TG-REF:672
Size / Tip:
4 1/2",size #3,
medium, 1 prong blade
4 1/2",size #4,
medium, 4 prong blade

Greishaber Wire Retractor

Self Retaining Retractor

TG-REF:673

Tip Blade End Lengthin
Sharp 3x4 Prongs 2 3/4"



Finsen Retractor

TG-REF:674

Tip Blade End Lengthin
Blunt 2x3 Prongs 3"



Finsen Modified Retractor

TG-REF:675

Tip Blade End Lengthin
Sharp 3x4 Prongs 2 3/4"



Finsen Screw Retractor

TG-REF:676

Tip Blade End Lengthin
Sharp 3x3 Prongs 2"

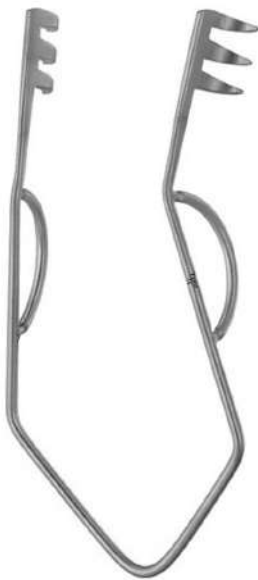

Parsonnet Epicardial Retractor

TG-REF:677

Tip Blade End Lengthin
Sharp 4x4 Prongs 2 3/4"
Sharp 4x4 Prongs 4"



**ALM Retractor
Thumb-Screw Tension**

TG-REF:678

Tip Blade End Lengthin
Blunt 4x4 Prongs 2 3/4"
Blunt 4x4 Prongs 4"



**ALM Retractor
Thumb-Screw Tension**



TAHIR GROUP OF INDUSTRIES



+92-300-6669737



TAHIR GROUP OF INDUSTRIES



TGIND.COM



TAHIR GROUP OF INDUSTRIES



tgindsale@gmail.com

Self Retaining Retractor



Weitlaner Self Retaining Retractor



Weitlaner Self Retaining Retractor

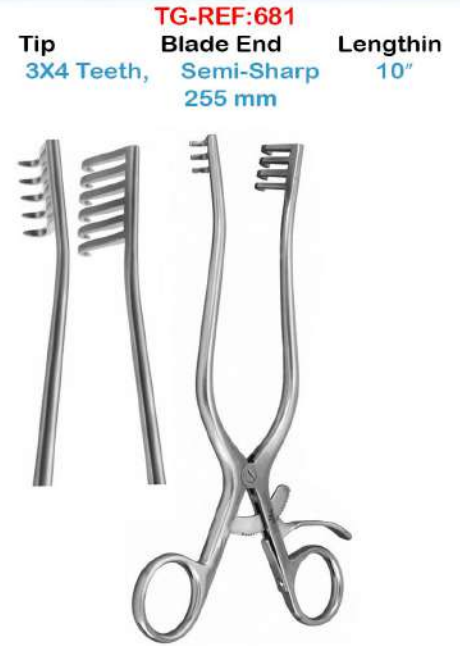

Weitlaner Self Retaining Retractor



Weitlaner Self Retaining Retractor



Weitlaner Self Retaining Retractor



Weitlaner Self Retaining Retractor



Weitlaner Self Retaining Retractor



Weitlaner Self Retaining Retractor



Weitlaner Self Retaining Retractor

Self Retaining Retractor

TG-REF:685

Tip
BLUNT
Blade End
130 mm,
Lengthin
5 1- 8"



Weitlaner Self Retaining Retractor

TG-REF:686

Tip
Sharp
Blade End
130 mm,
Lengthin
5 1- 8"



Weitlaner Self Retaining Retractor

TG-REF:687

Tip
BLUNT
Blade End
165 mm,
Lengthin
6 1 2"



Weitlaner Self Retaining Retractor

TG-REF:689

Tip
BLUNT
Blade End
130 mm,
Lengthin
5 1 8"



Weitlaner Self Retaining Retractor

TG-REF:690

Tip
BLUNT
Blade End
110 mm,
Lengthin
4 3- 8"



Weitlaner Self Retaining Retractor

TG-REF:691

Tip
SHARP
Blade End
165 mm,
Lengthin
6 1-2"

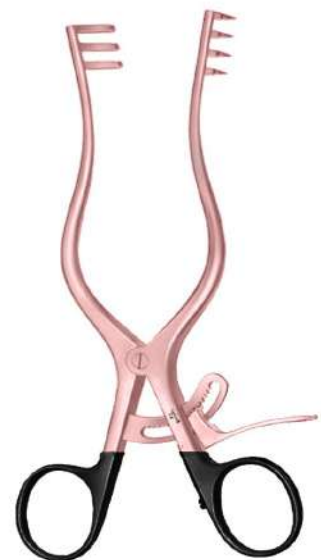

Weitlaner Self Retaining Retractor



TAHIR GROUP OF INDUSTRIES



+92-300-6669737



TAHIR GROUP OF INDUSTRIES



TGIND.COM



TAHIR GROUP OF INDUSTRIES



tgindsafe@gmail.com

Self Retaining Retractor

TG-REF:692

Tip 3x4 SHARP Blade End 130 mm, Lengthin 5 1/8



Weitlaner Self Retaining Retractor

TG-REF:693

Tip SHARP Blade End 110 mm, Lengthin 4 3/8"



Weitlaner Self Retaining Retractor

TG-REF:694

Tip SEMI-SHARP Blade End 165 mm, Lengthin 6 1/2"



Weitlaner Self Retaining Retractor

TG-REF:695

Tip Semi-sharp3x4 Blade End 130 mm, Lengthin 5 1-8"

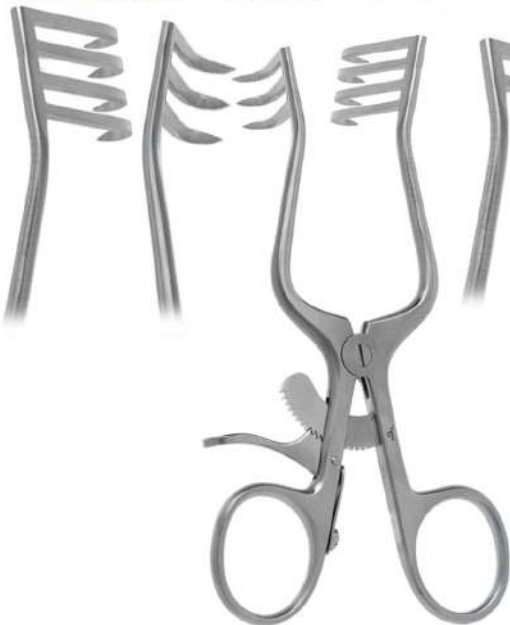

Weitlaner Self Retaining Retractor

TG-REF:696

Tip Semi-sharp2x3 Blade End 110 mm Lengthin 4 3-8"



Weitlaner Self Retaining Retractor

TG-REF:697

Tip sharp3x4 Blade End 165mm, Lengthin 6 1/2"



Weitlaner Self Retaining Retractor



TAHIR GROUP OF INDUSTRIES



+92-300-6669737



TAHIR GROUP OF INDUSTRIES



TGIND.COM



TAHIR GROUP OF INDUSTRIES



tgindsale@gmail.com

Self Retaining Retractor

TG-REF:697

Tip: 3x3 blunt
Blade End: 12.0mm Long
Length: 4 1/4"
Prongs: 35.0mm Spread



Wullstein Weitlaner Self Retaining Retractor

TG-REF:698

Tip: 3x3 blunt
Blade End: 14.0mm Long
Length: 5 1/8"
Prongs: 35.0mm Spread



Wullstein Weitlaner Self Retaining Retractor

TG-REF:699

Tip: 3x3 blunt
Blade End: 14.0mm Long
Length: 6"
Prongs: 35.0mm Spread

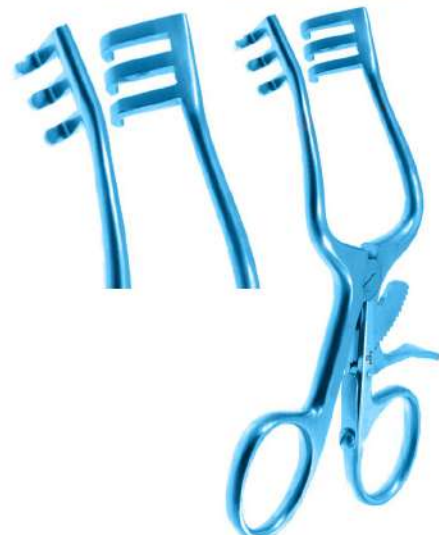

Wullstein Weitlaner Self Retaining Retractor

TG-REF:700

Tip: 3x3 Sharp
Blade End: 12.0mm Long
Length: 4 1/4"
Prongs: 35.0mm Spread



Wullstein Weitlaner Self Retaining Retractor

TG-REF:701

Tip: 3x3 Sharp
Blade End: 12.0mm Long
Length: 5 1/8"
Prongs: 35.0mm Spread



Wullstein Weitlaner Self Retaining Retractor

TG-REF:702

Tip: 3x3 Sharp
Blade End: 12.0mm Long
Length: 6"
Prongs: 35.0mm Spread



Wullstein Weitlaner Self Retaining Retractor



TAHIR GROUP OF INDUSTRIES



+92-300-6669737



TAHIR GROUP OF INDUSTRIES



TGIND.COM



TAHIR GROUP OF INDUSTRIES



tgindsale@gmail.com

Self Retaining Retractor

Size TG-REF:703
2 blunt prongs on right shaft
13.0mm long, solid 10.0mm x 20mm blade
Left shaft, 45.0mm spread



Bellucci Wullstein Self Retaining Retractor

Size TG-REF:704
2 blunt prongs on left shaft
13.0mm long, solid 10.0mm x 20mm blade
on right shaft, 45.0mm spread



Bellucci Wullstein Self Retaining Retractor

Size TG-REF:705
7 1/2", angled, 4x4 blunt prongs



Adson Self-Retaining Cerebellar Retractor

TG-REF:706
Tip 7x7 Sharp Prongs
Blade End: 70mm
Length: 11"



Mikimon Cerebellar Retractor

TG-REF:707
Size:
max. Opening: 225 mm / 10 "
max. Opening: 200 - 250 mm

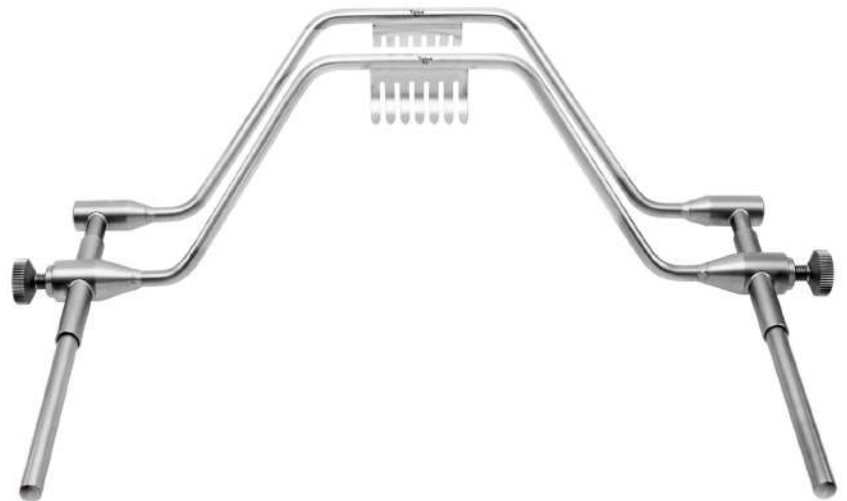

Abdominal Retractor Mahorner Thyroid

Self Retaining Retractor

TG-REF:708

Width close 35mm Width open 112mm Length 155mm



Jolls Thyroid Retractor

Size **TG-REF:709**
6",4x4 Sharp prongs



Millson Retractor

Size **TG-REF:710**
6",4x4 Blunt prongs



Millson Retractor

Size **TG-REF:711**
6 3/4", 2 blunt prongs



Mayo-Adams Appendectomy Retractor

Size **TG-REF:712**
12", sharp points



Wiltse-Gelpi self-retaining retractor

Size **TG-REF:713**
7" Sharp With Ball Stops



GELPI perineal retractor



TAHIR GROUP OF INDUSTRIES



+92-300-6669737



TAHIR GROUP OF INDUSTRIES



TGIND.COM



TAHIR GROUP OF INDUSTRIES



tgindsale@gmail.com



TG-REF:714

Tip	Length
Sharp	3 1/2"
Sharp	5 1/4"
Sharp	6 7/8"
Sharp	7 1/4"
Blunt	4 1/2"

Gelpi Vignal Retractor

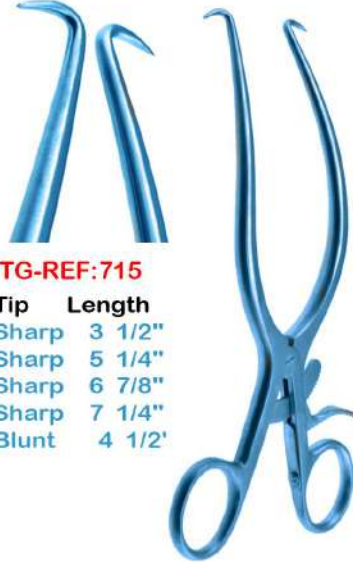

TG-REF:715

Tip	Length
Sharp	3 1/2"
Sharp	5 1/4"
Sharp	6 7/8"
Sharp	7 1/4"
Blunt	4 1/2"

Gelpi Vignal Retractor

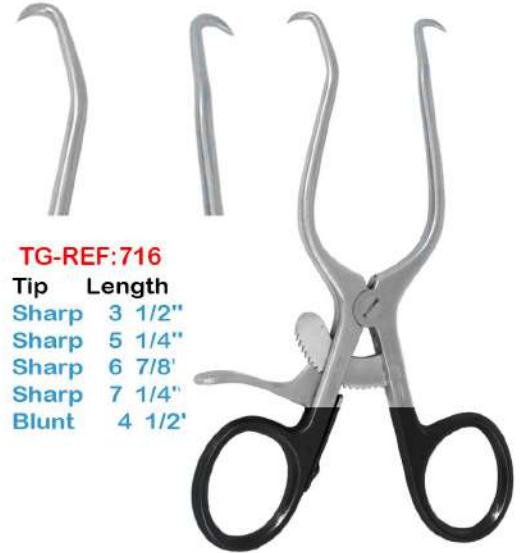

TG-REF:716

Tip	Length
Sharp	3 1/2"
Sharp	5 1/4"
Sharp	6 7/8"
Sharp	7 1/4"
Blunt	4 1/2"

Gelpi Vignal Retractor



TG-REF:717

Description	Blademm	Length 7"
Complete		
Center Blade Small	19x16	
Center Blade Medium	25x16	
Center Blade Large	32x16	
Center Blade X Large	76x16	
Side Blade Pair 4 Prong	25x25	
Side Blade Pair 4 Prongs	19x16	
Side Blade Pair 4 Prongs	19x16	
Frame Only		

Henly Retractor



TG-REF:718

Tip	Length
Children Sharp	4"
Adult Sharp	5 1/2"

Debakey Fremur Retractor

TG-REF:719
Tip Length
Blunt 7"



Jackson Burrows Retractor



TG-REF:720
Tip Length
Sharp 4x4 4"
Blunt 4x4 4"

Heiss Self-Retaining Retractor



TG-REF:721
Size:
6 3/4", 2 1/2" x 1"
wide blade on left side,
single hook on right side

Markham-Meyerding Hemilaminectomy Retractor

TG-REF:722
Size:
6 3/4", 2 1/2" x 1"
wide blade on Right side,
single hook



Markham-Meyerding Hemilaminectomy Retractor

TG-REF:723
Size:
7", 1 1/4" x 1"
7", 1 5/8" x 1"
2"x1"
2 1/4"x1"
7 1/2", 1 1/4"x1"
7 1/2", 2 1/8"x1"
7 1/2", 2 3/8"x3/4"
with teeth



Meyerding Retractor

TG-REF:724
Size:
7", 1 1/4" x 1"
7", 1 5/8" x 1"
2"x1"
2 1/4"x1"
7 1/2", 1 1/4"x1"
7 1/2", 2 1/8"x1"
7 1/2", 2 3/8"x3/4"
with teeth



Meyerding Retractor

TG-REF:725

Item	Lengthmm
Complete Set	
Spreader Only	
Center Blade	
Side Blade Pair	70mm
Side Blade Pair	90mm
Side Blade Pair	93mm
Side Blade Pair	150mm



Parks Rectal Spreader

TG-REF:724



ST Marks Modified Girona Perineal Retractor



TG-REF:726
Lengthin
8 7/8"

CZERNY Rectal Speculum



TG-REF:727
Blade Size:
58x23

BUIE-SMITH Anal Retractors

TG-REF:728

Size	Blade Size	Length
Small	70x19mm	10 3/4"
Medium	82x29mm	10 3/4"
Large	97x38	11 5/8"

Sawyer Retractor



TG-REF:729

Blade Size	Lengthmm
64x24mm	8 1/4"
n76x35mm	8 1/4"
76x32mm	8 1/4"

Hill Ferguson Retractor

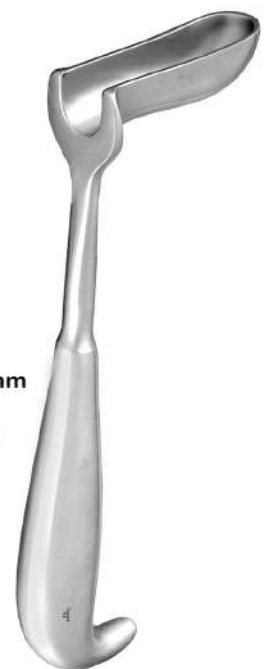



TG-REF: 730
Length
8 1/2"

Mathieu Rectal Spreader



TG-REF: 731
Size
3 1/4" Long 1 1/8"

Fansler Ives Rectal Speculum



TG-REF: 732
Size
23 cm ø 55 x 65 mm

FANSLER Anoscope Rectom



TG-REF: 733
Size:
8"

Pratt Rectal Speculum



TG-REF: 734
Size
6", 3 1/2" long x 5/8" diameter
fenestrated blades

Sims Speculum Fenestrated



TG-REF: 735
Size
6", 3 1/2" long x 5/8" diameter
Solid blades

Sims Speculum Solid



TG-REF: 730
Length
8 1/2"

Mathieu Rectal Spreader



TG-REF: 731
Size
3 1/4" Long 1 1/8"

Fansler Ives Rectal Speculum



TG-REF: 732
Size
23 cm ø 55 x 65 mm

FANSLER Anoscope Rectom



TG-REF: 733
Size:
8"

Pratt Rectal Speculum



TG-REF: 734
Size
6", 3 1/2" long x 5/8" diameter
fenestrated blades

Sims Speculum Fenestrated



TG-REF: 735
Size
6", 3 1/2" long x 5/8" diameter
Solid blades

Sims Speculum Solid



TG-REF:736
Length
small, 2 1/2" long x 7/8" diameter



TG-REF:737
Size
large, 2 1/2" long x 1 1/4" diameter



TG-REF:738
Size
Small, 2 1/4" long x 9/16" diameter
Large, 3 1/2" long x 7/8" diameter
medium, 2 5/8" long x 11/16" diameter

Chelsea-Eaton Anal Speculum

Chelsea-Eaton Anal Speculum

Hirschman Rectal Anoscope Speculum



TG-REF:739
Size
Small, 3 1/2" long x 1" diameter tapers to 1/2"
Medium, 4" long x 1" diameter tapers to 5/8"
Large, 4 3/4" long x 1 1/4" diameter tapers to 3/4"

Brinkerhoff rectal speculum



TG-REF:740

Kelly Sphincteroscope



TG-REF:741

Diameter	Workingmm	Length
21mm	54mm	6 1/4"
22mm	140mm	5 1/2"
25mm	50mm	6 1/4"

Kelly Sphincteroscope



TG-REF:736
Length
7.5"

McGivney Hemorrhoid Forceps



TG-REF:737
Size
9"

Stewart Crypt Hook



TG-REF:738
Size
6.75"

Rosser Crypt Hook



TG-REF:739
Size
6", double-ended,
curved tips,

Barr Fistula Probe



TG-REF:740
Size
8 1/4", narrow
crypt hook

Pratt Fistula Probe



TG-REF:741
Size
12 3/4"

**Rudd Hemorrhoid
Ligator Rectal**





TG-REF:742

Size

8"-7"-6"-5 1/2"-5"-4 1/2"
with tongue
tie and plain end

Grooved Director



TG-REF:743

Size

8"-7"-6"-5 1/2"-5"-4 1/2"
with tongue
tie and probe end

Grooved Director



TG-REF:744

Size

5 3/4"
Curved

Doyen Director



TG-REF:745

Size

6 1/4"

Nelaton Director



TG-REF:746

Size

Straight

**Lockhart-Mummery
fistula probe**



TG-REF:747

Size

45° curved

**Lockhart-Mummery
fistula probe**



TG-REF:748

Size

90° curved

**Lockhart-Mummery
fistula probe**



TG-REF:749

Size

retrograde curved

**Lockhart-Mummery
fistula probe**



TAHIR GROUP OF INDUSTRIES



+92-300-6669737



TAHIR GROUP OF INDUSTRIES



TGIND.COM



TAHIR GROUP OF INDUSTRIES



tgindsale@gmail.com



TG-REF:750
Tip Length
Small 9 1/2"
Medium 9 1/2"
Large 9 1/2"

Ferguson Gall Stone Ccoop



TG-REF:751
Tip Length
6mm 11 1/4"
7mm 11 1/4"
8mm 11 1/4"
9mm 11 1/4"

Desjardins Gall Stone Probes



TG-REF:752
Tip Length
1 12 3/8"
2 12 3/8"
3 12 3/8"
4 12 3/8"
5 12 3/8"
6 12 3/8"
7 12 3/8"
8 12 3/8"
9 12 3/8"
10 12 3/8"
11 12 3/8"
12 12 3/8"
13 12 3/8"

Bake Bile-Duct Dilators



TG-REF:753
Tip Length
2.8mm 12 3/4"
3.4mm 12 3/4"
5.5mm 12 3/4"
6.7mm 12 3/4"
8.0mm 12 3/4"
11.0mm 12 3/4"
15.0mm 12 3/4"

Leur-Koerte Scoops, Malleable Shaft



TG-REF:754
Tip Length
3.8mm 11 1/4"
4.3mm 11 1/4"
6.8mm 11 1/4"

Probe With Eye

TG-REF:755
Tipmm Tip Length
5mm Malleable 13"



Mayo Gall Duct Probe



TG-REF:756
Tip Length
3/4 mm
5/6 mm
7/8 mm
9/10 mm
11/12 mm
13/14 mm
15/16 mm
17/18 mm
19mm/20mm
21mm/22mm

10 Pieces Set of Hegar Uterine Dilators



TG-REF:757

Tip	Length
Small	9 1/2"
Medium	9 1/2"
Large	9 1/2"

Ferguson Gall Stone Ccoop



TG-REF:758

Tip	Length
6mm	11 1/4"
7mm	11 1/4"
8mm	11 1/4"
9mm	11 1/4"

Desjardins Gall Stone Probes



TG-REF:759

Tip Length	
1	12 3/8"
2	12 3/8"
3	12 3/8"
4	12 3/8"
5	12 3/8"
6	12 3/8"
7	12 3/8"
8	12 3/8"
9	12 3/8"
10	12 3/8"
11	12 3/8"
12	12 3/8"
13	12 3/8"

Bake Bile-Duct Dilators

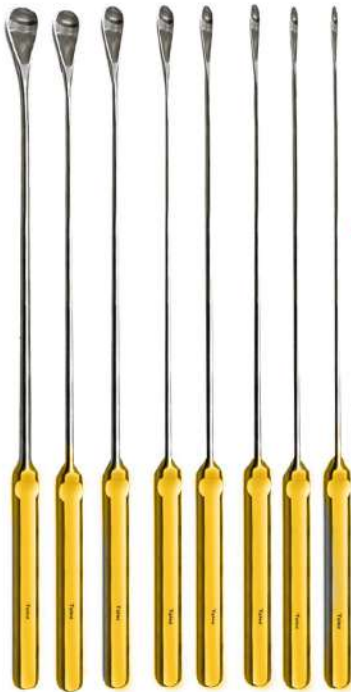

TG-REF:760

Tip	Length
2.8mm	12 3/4"
3.4mm	12 3/4"
5.5mm	12 3/4"
6.7mm	12 3/4"
8.0mm	12 3/4"
11.0mm	12 3/4"
15.0mm	12 3/4"

Leur-Koerte Scoops, Malleable Shaft



TG-REF:761

Tip	Length
3.8mm	11 1/4"
4.3mm	11 1/4"
6.8mm	11 1/4"

Desjardins Gall Duct Probes

TG-REF:762

Tip	Length
5mm	Malleable
	13"



Mayo Gall Duct Probe

TG-REF:763

Tip Sizes:	
3/4 mm	13/14 mm
5/6 mm	15/16 mm
7/8 mm	17/18 mm
9/10 mm	19mm/20mm
11/12 mm	21mm/22mm



Set Of 10 Hegar Uterine Dilators Multicolor

Scalpel Handle

TGIND
Instruments



TG-REF:764
Size:
5 1/2"



TG-REF:765
Size:
8"
9"



TG-REF:766
Size:
7"



TG-REF:767
Size:
8 1/4"



TG-REF:768
Size:
8"
9"

Corwin Knife Handle

Landot Scalpel Handle

Casper Scalpel Handle

Transspenoidal Scalpel Handle

Landot Scalpel Handle



TG-REF:769
#3 Scalpel Handle
12.5cm
Blade Size 10,
11,12,13,15,17



TG-REF:770
#3 Scalpel Handle
Graduated 12.75cm
Blade Size 10,
11,12,13,15,17



TG-REF:771
#4 Scalpel Handle
Graduated 12.75cm
With Scale



TG-REF:772
#4 Scalpel Handle
12.75cm Blade
Blade Size 18,
20,21,22,23,24
,25,60,70



TG-REF:773
#4 Scalpel Handle
Graduated 12.75cm
Blade Size 18,
20,21,22,23,24
,25,60,70



TG-REF:774
#4LA Scalpel Handle
21cm
Blade Size 18,
20,21,22,23,24
,25,60,70



TAHIR GROUP OF INDUSTRIES



+92-300-6669737



TAHIR GROUP OF INDUSTRIES



TGIND.COM



TAHIR GROUP OF INDUSTRIES



tgindsale@gmail.com

Scalpel Handle

TGIND
Instruments



TG-REF:775
#3-#4 Scalpel Handle
12.5cm
Double Ended
16cm



TG-REF:776
Scalpel Handle
3L Long 21cm
Blade Size 10,
11,12,15,17



TG-REF:777
#7 Scalpel Handle
16.5cm
Blade Size 10,
11,12,13,15,17



TG-REF:778
Scalpel Handle
Fig.10-17
12.5cm
Solid



TG-REF:779
Scalpel Handle
4L Long 21cm
Blade Size 18,
20,21,22,23,24
,25,60,70



TG-REF:780
Scalpel Handle
#3LA Long Angled
20.25cm
Blade Size 10,
11,12,15,17



TG-REF:781
Knife Handle
(Smooth) for
Blade Nos 60 & 70



TG-REF:782
Siegel Round
Scalpel Handle
#3 with adjustable Tip
16cm
Blade Size 10,
11,12,13,15,17



TG-REF:783
Siegel Round
Scalpel Handle
#4 with adjustable Tip
16cm
Blade Size 18,
20,21,22,23,24
25,60,70



TG-REF:784
Round Knurled
Scalpel Handle
12.7cm
Blade Size 50,60,70



TG-REF:785
Round Knurled
Scalpel Handle
12.7cm
Blade Size 50,60,70



TG-REF:786
Round Knurled
Scalpel Handle
11cm
Blade Size 50,60,70



TG-REF:787
Round Knurled
Scalpel Handle
13.5cm
Blade Size 50,60,70



TG-REF:788
Beaver
Handle



TAHIR GROUP OF INDUSTRIES



+92-300-6669737



TAHIR GROUP OF INDUSTRIES



TGIND.COM



TAHIR GROUP OF INDUSTRIES



tgindsale@gmail.com

119

Scalpel Handle



TG-REF:789
Round Knurled
Scalpel Handle
12cm



TG-REF:790
#3RK Kaye
Round Scalpel
Handle 15cm
Blade Size:10,11
12,13,15,17



TG-REF:791
#3RK Crowin
Round Scalpel
Handle 14.5cm
Blade Size:10,11
12,15,17



TG-REF:792
#4RK Crowin
Round Scalpel
Handle 14.5cm
Blade Size:18,20,
21,22,23,24,25,60,0



TG-REF:793
#3RC Scalpel
Handle
14cm
Blade Size 10,
11,12,13,15,17



TG-REF:794
4L Long Scalpel
Handle
21cm
Blade Size 18,
20,21,22,23,24
,25,60,70



TG-REF:795
Scalpel Handle
15cm
Blade Size 10-17
With Round
Hollow Handle



TG-REF:796
Scalpel Handle



TG-REF:797
Scalpel Grip



TG-REF:798
Bever Handle



TG-REF:799
Round
Scalpel Handle
#3 Double Head
Blade Size 10,
11,12,13,15,17



TG-REF:800
Scalpel Plastic
Handle
#8 Blade Size 18,20,21
22,23,24,25,60,70



TG-REF:801
Collin Scalpel
Handle
#9 Blade Size
10,11,12,13,15,17



Fig. 10 Fig. 11
Blade Sizes



Fig. 12 Fig. 15



TG-REF:802
Scalpel Plastic
Handle



TG-REF:803
Scalpel Plastic
Handle #5
#5 Blade Size
10,11,12,13,15,17



TG-REF:804
Scalpel Plastic
Handle #6
#6 Blade Size
18,20,21,22,23,24
25,60,70



Fig. 20



Fig. 22



Scalpel Handle

TGIND
Instruments



TG-REF:805
Cole-Parmer Dissecting
Blade Remover For
Blade Handle



TG-REF:806
Troutman Chirs
Blade Breaker & Holder
With Push-Pul Lock 9cm



TG-REF:807
Troutman Chirs
Blade Breaker & Holder
Angled With Push-Pul Lock 9cm



TG-REF:808
Blade Holder Blade
Breaker & Holder
With Ratchet Lock
13cm



TG-REF:809
Castroviejo Blade
Breaker & Holder
With Push-Pull
Lock 13cm



TG-REF:810
Razor Blade
Breaker & Holder
With Push-Pull
Lock 13cm



Dieffenbach
16cm
TG-REF:811



Fig-1 16cm
Fig-2 16cm
Fig-3 16cm
Fig-4 16cm
Fig-5 16cm



Fig-6 16cm
Fig-7 16cm
Fig-8 16cm
Fig-9 16cm
Fig-10 16cm



Fig-15
16cm



Fig-16
16cm



TAHIR GROUP OF INDUSTRIES



+92-300-6669737



TAHIR GROUP OF INDUSTRIES



TGIND.COM



TAHIR GROUP OF INDUSTRIES



tgindsale@gmail.com

121

Scalpel Blades

TGIND
Instruments



TG-REF:812
Sterile Scalpel
Blade #6
Stainless Steel



TG-REF:813
Sterile Scalpel
Blade #10
Stainless Steel



TG-REF:814
Sterile Scalpel
Blade #10A
Stainless Steel



TG-REF:815
Sterile Scalpel
Blade #11
Stainless Steel



TG-REF:816
Sterile Scalpel
Blade #11P
Stainless Steel



TG-REF:817
Sterile Scalpel
Blade #E11
Stainless Steel



TG-REF:818
Sterile Scalpel
Blade #12
Stainless Steel



TG-REF:819
Sterile Scalpel
Blade #13
Stainless Steel



TG-REF:820
Sterile Scalpel
Blade #15
Stainless Steel



TG-REF:821
Sterile Scalpel
Blade #15A
Stainless Steel



TG-REF:822
Sterile Scalpel
Blade #17
Stainless Steel



TG-REF:823
Sterile Scalpel
Blade #18
Stainless Steel



TG-REF:824
Sterile Scalpel
Blade #20
Stainless Steel



TG-REF:825
Sterile Scalpel
Blade #21
Stainless Steel



TG-REF:826
Sterile Scalpel
Blade #22
Stainless Steel



TG-REF:827
Sterile Scalpel
Blade #23
Stainless Steel



TG-REF:828
Sterile Scalpel
Blade #24
Stainless Steel



TG-REF:829
Sterile Scalpel
Blade #25
Stainless Steel



TG-REF:830
Sterile Scalpel
Blade #36
Stainless Steel



TG-REF:831
Sterile Scalpel
Blade #40
Stainless Steel



TG-REF:832
Sterile Scalpel
Blade #60
Stainless Steel



TG-REF:833
Sterile Scalpel
Blade #70
Stainless Steel



TAHIR GROUP OF INDUSTRIES



+92-300-6669737



TAHIR GROUP OF INDUSTRIES



TGIND.COM



TAHIR GROUP OF INDUSTRIES



tgindsale@gmail.com

Dissecting Knives



TG-REF:834
Collin Dissecting
Knives
Blade Handle
13cm,16cm,19cm
22cm,28cm



TG-REF:835
Catlin Dissecting
Knives
Blade Handle
16cm,19cm
22cm



TG-REF:836
Liston Dissecting
Knives
Blade Handle
16cm,19cm
22cm



TG-REF:837
Langenbeck Dissecting
Knives
Blade Handle
12cm



TG-REF:838
Amputation
Knife
29cm



TG-REF:839
Amputation
Knife
32.5cm



TG-REF:840
Catlin Amputation
Knife
29cm



TG-REF:841
Resection Knife
18cm



TG-REF:842
Langenbeck
Amputation
18cm



TG-REF:843
Langenbeck
Amputation
18cm



TG-REF:844
Dieffenbach
Dissecting Knives
13cm



TG-REF:845
Dieffenbach
Dissecting Knives
13cm



TG-REF:846
Simon Dissecting
Knives
23.5cm



Fig:1



Fig:2



Fig:3



Fig:4



Dissecting Knives



TG-REF:847
Autopsy Knives
25.5cm



TG-REF:848
Walb Dissecting
Knives
11cm



TG-REF:849
Walb Dissecting
Knives
14cm



TG-REF:850
Walb Dissecting
Knives
17cm



TG-REF:851
Virchow
Dissecting Knives
16cm



TG-REF:852
Virchow
Dissecting Knives
20cm



TG-REF:853
Virchow
Dissecting Knives
24cm



TG-REF:854
Ayre Cone Knife
13.5cm



TG-REF:855
Cone Knife
23cm



TG-REF:856
Segnod
Myomatome
27cm



TG-REF:857
Olivecrona
Trigeminal Knife
20.5cm



TG-REF:858
Trigeminal Knife
23cm



TG-REF:859
Flowler
Tonsil Knife
20cm



TG-REF:860
Abraham
Tonsil Knife
21.5cm



TG-REF:861
Brunings
Tonsil Knife
21.5cm



TAHIR GROUP OF INDUSTRIES



+92-300-6669737



TAHIR GROUP OF INDUSTRIES



TGIND.COM



TAHIR GROUP OF INDUSTRIES



tgindsale@gmail.com

TG-REF:862
Size
31cm



**Satterlee Amputation
& Resection**

TG-REF:863
Size
27cm
30cm



**Charriere Amputation
Resection**

TG-REF:864
Size
35cm



**Bone Saws Charriere
Amputation**

TG-REF:865
Size:
6"



Bone Saw Angled

TG-REF:866
Size
18cm



**Bergmann Plaster
Of-Paris Saw**

TG-REF:867
Size
23cm



Langenbeck Metacarpal



TAHIR GROUP OF INDUSTRIES



+92-300-6669737



TAHIR GROUP OF INDUSTRIES



TGIND.COM



TAHIR GROUP OF INDUSTRIES



tgindsale@gmail.com

Suction Tube

TGIND
Instruments

TG-REF:868
Size
9", 23 French,
curved



Pool suction Tube

TG-REF:669
Size
9" 30 French,
straight



Pool suction Tube

TG-REF:870
Size
12" 30 French,
Straight



Pool suction Tube

TG-REF:871
Size
8", 17 French,
pediatric, curved



Pool suction Tube

TG-REF:872
Size:
9 1/2"
angled 75°
working length 170mm
thumb plate with cutoff
7 French
8 French
9 French
10 French
11 French
12 French



Frazier Suction Tube

TG-REF:873
Size:
6"
angled 90°
working length 75mm
thumb plate with cutoff



Frazier Suction Tube

TG-REF:874
Size:
6"
angled 90°
working length 170mm
thumb plate with cutoff



Frazier Suction Tube



TAHIR GROUP OF INDUSTRIES



+92-300-6669737



TAHIR GROUP OF INDUSTRIES



TGIND.COM



TAHIR GROUP OF INDUSTRIES



tgindsale@gmail.com

126

TG-REF:875

Size
7"
4 French
5 French
6 French
7French
8 French
12 French
14 French
15 French
16 French
18 French
angled, working
length 100mm,
thumb plate
with cutoff hole



Frazier Suction Tube

TG-REF:676

Size
10",
7 French
8 French
9 French
10 French
11French
12 French
angled, working
length 180mm,
thumb plate
with cutoff hole



Frazier Suction Tube

TG-REF:877

Size
12 1/2",
7 French
9 French
11 French
angled, working
length 180mm,
thumb plate
with cutoff hole



Frazier Suction Tube

TG-REF:879

Size:
6 1/8"
3 French
5 French
angled working
length 90mm
angled, working
with cutoff hole



House-Baron Suction Tube

TG-REF:880

Size:
20 gauge
22 gauge
24 gauge
angled, working
length 78mm
angled working
length 90mm
angled, working
with cutoff hole
Schuknecht suction tube



Schuknecht Suction Tube

TG-REF:881

Size:
7"
8French
9 French
10 French
11 French
12French
13 French
14French
angled working
length 100mm
angled, working
with cutoff hole



Schuknecht Suction Tube



Suction Tube

TGIND
Instruments

TG-REF:882

Size
5 1/2"
2.5 x 4.0 French,
4.0 x 5.0 French
angled, working
length 95mm,
thumb plate with cutoff

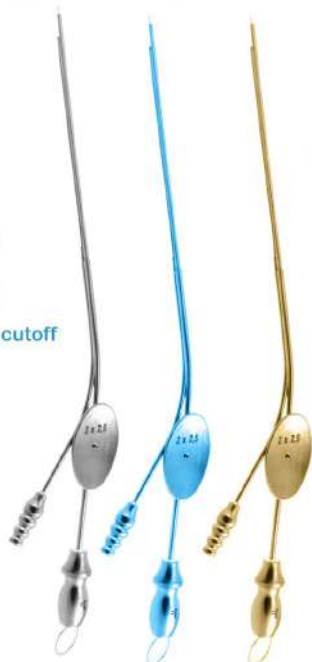

House Suction Irrigator

TG-REF:683

Size
8 1/2",
12 French,
15 French,
angled 20°
thumb plate
with cutoff hole

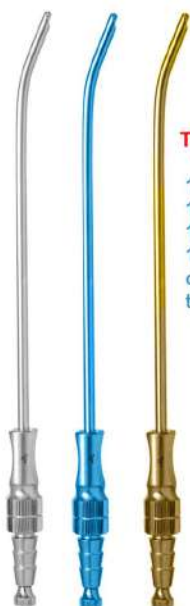

Adson Suction Tube

TG-REF:884

Size
10 French, working length 150mm
12 French, working length 140mm
14 French, working length 125mm
15 French, working length 150mm
curved,
thumb plate with cutoff



Adson Suction Tube

TG-REF:885

Size:
6 3/4"
9 French
angled,
working length 120mm
thumb plate with cutoff



Barnes Suction tube

TG-REF:886

Size:
4 French
5 French
6 French
angled,
working length 50mm
thumb plate
with cutoff hole



Barnes Suction Tube

TG-REF:881

Size:
6"
18 gauge angled,
20 gauge angled,
22 gauge angled,
working length
150mm
thumb plate
with cutoff hole



Bellucci Suction Tube



TAHIR GROUP OF INDUSTRIES



+92-300-6669737



TAHIR GROUP OF INDUSTRIES



TGIND.COM



TAHIR GROUP OF INDUSTRIES



tgindsale@gmail.com

128

TG-REF:882

Size
5 1/2"
2.5 x 4.0 French,
4.0 x 5.0 French
angled, working
length 95mm,
thumb plate with cutoff



Brackman Suction Tube

TG-REF:683

Size
6 1/8"
4x5 French angled
5x7 French angled
7 French angled
working length 105mm
offset holes
thumb plate with cutoff hole



Brackman Suction Tube

TG-REF:884

Size
6 1/4"
3 French
4 French
5 French
6 French
strongly angled
working length 100mm
thumb plate with cutoff hole



Ferguson-Frazier Suction Tube

TG-REF:885

Size:
7"
5 French, angled
6 French, angled
7 French, angled
8 French, angled
9 French, angled
10 French, angled
12 French, angled
working length 100mm
thumb plate
with cutoff hole



Frazier Calibrated Suction Tube

TG-REF:886

Size:
8"
5 French, angled
6 French, angled
7 French, angled
8 French, angled
9 French, angled
10 French, angled
12 French, angled
working length 150mm
thumb plate
with cutoff hole



Ferguson-Frazier Suction Tube

TG-REF:887

Size:
10"
6 French, angled
7 French, angled
8 French, angled
9 French, angled
10 French, angled
11 French, angled
12 French, angled
14 French, angled
working length 200mm
thumb plate
with cutoff hole



Bellucci Suction Tube



TAHIR GROUP OF INDUSTRIES



+92-300-6669737



TAHIR GROUP OF INDUSTRIES



TGIND.COM



TAHIR GROUP OF INDUSTRIES



tgindsale@gmail.com

TG-REF:888

Size
5 1/2"
3 French angled
5 French angled
6 French angled
7 French angled
8 French angled
9 French angled
11 French angled
12 French angled
working length 50mm,
thumb plate
with cutoff hole



Frazier Suction Tube

TG-REF:689

Size
10"
3 French straight
5 French straight
6 French straight
7 French straight
8 French straight
9 French straight
11 French straight
12 French straight
14 French straight
15 French straight
working length 180mm,
thumb plate with
round cutoff hole



Frazier Suction Tube

TG-REF:890

Size
10"
3 French straight
5 French straight
6 French straight
7 French straight
8 French straight
9 French straight
11 French straight
12 French straight
14 French straight
15 French straight
working length 180mm,
thumb plate with
Slotted cutoff hole



Frazier Suction Tube

TG-REF:891

Size
10"
3 French angled
5 French angled
6 French angled
7 French angled
8 French angled
9 French angled
11 French angled
12 French angled
14 French angled
15 French angled
working length 180mm,
thumb plate with
round cutoff hole



Frazier Suction Tube

TG-REF:892

Size
10"
3 French angled
5 French angled
6 French angled
7 French angled
8 French angled
9 French angled
11 French angled
12 French angled
14 French angled
15 French angled
working length 180mm,
thumb plate with
Slotted cutoff hole



Frazier Suction Tube

TG-REF:893

Size:
10"
6 French, angled
7 French, angled
8 French, angled
9 French, angled
10 French, angled
11 French, angled
12 French, angled
14 French, angled
working length 200mm
thumb plate
with cutoff hole



Peck suction tube



TG-REF:894

Size
10"
3 French angled
5 French angled
6 French angled
7 French angled
8 French angled
9 French angled
11 French angled
12 French angled
14 French angled
15 French angled
working length 180mm,
thumb plate with
Slotted cutoff hole



Frazier Suction Tube

TG-REF:695

Size
10"
3 French straight
5 French straight
6 French straight
7 French straight
8 French straight
9 French straight
11 French straight
12 French straight
14 French straight
115 French straight
working length 180mm,
thumb plate with
round cutoff hole



Frazier Suction Tube

TG-REF:896

Size
10"
3 French straight
5 French straight
6 French straight
7 French straight
8 French straight
9 French straight
11 French straight
12 French straight
14 French straight
115 French straight
working length 180mm,
thumb plate with
Salloted cutoff hole



Frazier Suction Tube

TG-REF:897

Size:
7 1/2", long, curved shaft,
multi-hole artaumatic tip,
working length 125mm
5 1/2", short, curved shaft,
multi-hole artaumatic tip,
working length 75mm



Pacifico suction tube

TG-REF:898

Size:
4"
20 gauge angled
22 gauge angled
24 gauge angled
working length 75mm



Guilford-Wright suction

TG-REF:899

Size:
4 1/8"
20 gauge, straight
22 gauge, straight



**House suction tube
with obturator**



TAHIR GROUP OF INDUSTRIES



+92-300-6669737



TAHIR GROUP OF INDUSTRIES



TGIND.COM



TAHIR GROUP OF INDUSTRIES



tgindsale@gmail.com

TG-REF:900
Size
11" angled
11 3/4" angled



Vascular/Thoracic suction tube

TG-REF:901
Size
5 3/4" long curved
2.5mm diameter bulbous tip
3.0mm diameter bulbous tip
4.0mm diameter bulbous tip
5 3/4" short curved
2.5mm diameter bulbous tip



Sinus Suction Tube

TG-REF:902
Size
10"
3 French straight
5 French straight
6 French straight
7 French straight
8 French straight
9 French straight
11 French straight
12 French straight
14 French straight
115 French straight
working length 180mm,
thumb plate with
Salloted cutoff hole



Rosen Suction Tube

TG-REF:903
Size:
12" Adult
14" Adult
16" Adult
18" Adult



Yankauer suction tube

TG-REF:904
Size:
18 gauge diameter tube
20 gauge diameter tube
straight shaft
1.9mm long three-prong tip,
squeeze action handle



Intraocular Foreign Body Forceps

TG-REF:905
Size:
133.0cm length
45.0cm length
5.0mm diameter,
with luer fitting



Suction/irrigation tube



TAHIR GROUP OF INDUSTRIES



+92-300-6669737



TAHIR GROUP OF INDUSTRIES



TGIND.COM



TAHIR GROUP OF INDUSTRIES



tgindsale@gmail.com

TG-REF:906

Size
3.0mm
4.2mm
6.0mm



Andrews suction tube

TG-REF:907

Size
19 French, straight
24 French, straight



Anthony suction tube

TG-REF:908

Size
10"
6 French, angled



Anthony suction tube

TG-REF:909

Size:
11 1/2",
angled,
5.0mm tip



**Brompton Vascular
Suction Tube**

TG-REF:910

Size:
12", angled,
working length 180mm,
round perforated end



**Cooley Vascular Graft
Suction Tube**

TG-REF:911

Size:
Diameter 3.0mm, Length 21cm,
6mm Diameter Tip With
Distal opening 4 Side
Opening Mounted On a Short
3mm Outside Diameter tube



Morse Andrews Suction Tube



TAHIR GROUP OF INDUSTRIES



+92-300-6669737



TAHIR GROUP OF INDUSTRIES



TGIND.COM



TAHIR GROUP OF INDUSTRIES



tgindsate@gmail.com

Suction Tube

TGIND
Instruments



TG-REF:912
Size
13"
angled 30°, left vent
angled 30°, right vent

Cooley Sump Suction Tube



TG-REF:913
Size
12" angled
working length 180mm
round perforated end

Cooley Vascular Suction Tube



TG-REF:914
Size
6 1/4"
angled, set of 2

Cottle Suction Tube



TG-REF:915
Size:
6 3/4",
3 French, angled
working length 110mm,
5 French, angled
working length 110mm,
6 1/8", 7 French, angled
working length 90mm,
6 3/4", 7 French, angled,
working length 110mm,
thumb plate with cutoff hole

Cottle Suction Tube



TG-REF:916
Size:
6" working length 100mm
8" working length 204mm

DeBakey-Adson Suction Tube



TG-REF:917
Size:
11"
center opening,
lateral slots

DeBakey Suction Tube



TAHIR GROUP OF INDUSTRIES



+92-300-6669737



TAHIR GROUP OF INDUSTRIES



TGIND.COM



TAHIR GROUP OF INDUSTRIES



tgindsale@gmail.com

Suction Tube

TGIND
Instruments



TG-REF:918
Size
9", curved,
removable tip



**Andrews-Pynchon
Suction Tube**



TG-REF:919
Size
8 5/8", 7 French,
working length 220mm



Jako laryngeal Suction Tube



TG-REF:920
Size
9"
6 French
10 French
11 French
12 French
angled working
length 146.0mm
thumb plate with cuto

Poppen Suction Tube

TG-REF:921
Size:
7"
size #1
size #2
malleable tube
working length 30mm
thumb plate
with cutoff hole



Kahn-Frazier suction tube

TG-REF:922
Size:
6"working length 100mm
8"working length 204mm

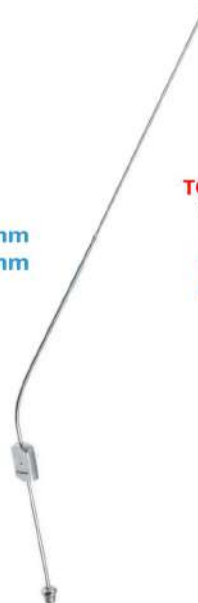

DeBakey-Adson Suction Tube

TG-REF:923
Size:
11"
center opening,
lateral slots



DeBakey Suction Tube



TAHIR GROUP OF INDUSTRIES



+92-300-6669737



TAHIR GROUP OF INDUSTRIES



TGIND.COM



TAHIR GROUP OF INDUSTRIES



tgindsale@gmail.com

135

TG-REF:924

Size
2.0mm O.D.
2.5mm O.D.
3.0mm O.D.



Kleinsasser laryngeal suction tube

TG-REF:925

Size
5 French, angled
working length 115mm
working length 165mm
working length 230mm
thumb plate with cutoff hole



Multi-hole Suction Tube

TG-REF:926

Size
7 French, angled
working length 115mm
working length 165mm
working length 230mm
thumb plate with cutoff hole



Multi-hole Suction Tube

TG-REF:927

Size:
7 1/4"
3 French, angled
4 French, angled
5 French, angled
6 French, angled
7 French, angled
8 French, angled
9 French, angled
10 French, angled
11 French, angled
working length 137mm



Fukushima Tapered Teardrop Suction Tube

TG-REF:928

Size:
8 1/4"
3 French, angled
4 French, angled
5 French, angled
6 French, angled
7 French, angled
8 French, angled
9 French, angled
10 French, angled
11 French, angled
working length 159mm



Fukushima Tapered Teardrop Suction Tube

TG-REF:929

Size:
10", small, angled
10 1/2", medium, angled
10 3/4", large, angled
6.0mm diameter



Intra-cardiac Suction Tube



TAHIR GROUP OF INDUSTRIES



+92-300-6669737



TAHIR GROUP OF INDUSTRIES



TGIND.COM



TAHIR GROUP OF INDUSTRIES



tgindsate@gmail.com

TG-REF:930

Size:
9 1/4"
3 French, angled
4 French, angled
5 French, angled
6 French, angled
7 French, angled
8 French, angled
9 French, angled
10 French, angled
11 French, angled
12 French, angled
working length 178mm



**Fukushima Tapered
Teardrop Suction Tube**

TG-REF:931

Size:
10 1/4"
3 French, angled
4 French, angled
5 French, angled
6 French, angled
7 French, angled
8 French, angled
9 French, angled
10 French, angled
11 French, angled
12 French, angled
working length 203mm



**Fukushima Tapered
Teardrop Suction Tube**

TG-REF:932

Size:
7"
3 French, Malleable
4 French, Malleable
5 French, Malleable
6 French, Malleable
7 French, Malleable
8 French, Malleable
9 French, Malleable
10 French, Malleable
11 French, Malleable
12 French, Malleable
working length 120mm



**Fukushima Tapered
Teardrop Suction Tube**

TG-REF:933

Size:
8 1/4"
3 French, Malleable
4 French, Malleable
5 French, Malleable
6 French, Malleable
7 French, Malleable
8 French, Malleable
9 French, Malleable
10 French, Malleable
11 French, Malleable
working length 153mm



**Fukushima Tapered
Teardrop Suction Tube**

TG-REF:934

Size:
8 3/4"
3 French, Malleable
4 French, Malleable
5 French, Malleable
6 French, Malleable
7 French, Malleable
8 French, Malleable
9 French, Malleable
10 French, Malleable
11 French, Malleable
12 French, Malleable
working length 159mm



**Fukushima Tapered
Teardrop Suction Tube**

TG-REF:935

Size:
9 1/2"
3 French, Malleable
4 French, Malleable
5 French, Malleable
6 French, Malleable
7 French, Malleable
8 French, Malleable
9 French, Malleable
10 French, Malleable
11 French, Malleable
12 French, Malleable
working length 178mm



**Fukushima Tapered
Teardrop Suction Tube**



TAHIR GROUP OF INDUSTRIES



+92-300-6669737



TAHIR GROUP OF INDUSTRIES



TGIND.COM



TAHIR GROUP OF INDUSTRIES



tgindsale@gmail.com

TG-REF:936
Size:
12 1/2", curved



O'Grady coronary artery suction tube

TG-REF:937
Size:
5 French, angled,
working length 125mm
working length 146mm
thumb plate with cutoff hole



McCulloch-type suction tube

TG-REF:938
Size:
7 French, angled,
working length 125mm
working length 146mm
thumb plate with cutoff hole



McCulloch-type suction tube

TG-REF:939
Size:
9 French, angled,
working length 125mm
working length 146mm
thumb plate with cutoff hole



McCulloch-type suction tube

TG-REF:940
Size:
12 French, angled,
working length 125mm
working length 146mm
thumb plate with cutoff hole



McCulloch-type suction tube

TG-REF:941
Size:
11"
4 French, angled
5 French, angled
6 French, angled
7 French, angled
8 French, angled
9 French, angled
working length 222mm



Fukushima Tapered Teardrop Suction Tube

TG-REF:943

Size:
7 1/2", angled
size #1 & #2
working length 64mm
fluted fixed tip



Pediatric Suction Tube

TG-REF:949

Size:
5 1/2"
16 gauge, curved
18 gauge, curved
thumb plate with cutoff hole



Pribram suction tube

TG-REF:950

Size:
3 French, angled
4 French, angled
5 French, angled
6 French, angled
7 French, angled
8 French, angled
9 French, angled
10 French, angled
11 French, angled
12 French, angled
working length 150mm



Fukushima teardrop suction tube

TG-REF:951

Size:
3 French, angled
4 French, angled
5 French, angled
6 French, angled
7 French, angled
8 French, angled
9 French, angled
10 French, angled
11 French, angled
12 French, angled
working length 180mm



Fukushima teardrop suction tube

TG-REF:952

Size:
3 French, angled
4 French, angled
5 French, angled
6 French, angled
7 French, angled
8 French, angled
9 French, angled
10 French, angled
11 French, angled
12 French, angled
working length 200mm



Fukushima teardrop suction tube

TG-REF:953

Size:
7"
4 French, angled
5 French, angled
6 French, angled
7 French, angled
8 French, angled
9 French, angled
10 French, angled
working length 120mm



Fukushima Tapered Teardrop Suction Tube



TAHIR GROUP OF INDUSTRIES



+92-300-6669737



TAHIR GROUP OF INDUSTRIES



TGIND.COM



TAHIR GROUP OF INDUSTRIES



tgindsale@gmail.com

Suction Tube

TGIND
Instruments

TG-REF:954

Size:
6"

3 French, angled shaft,
straight atraumatic tip,
working length 80mm



Merz Suction Tube

TG-REF:955

Size:
8"

3 French, angled shaft
angled up atraumatic tip
working length 125mm



Merz Suction Tube

TG-REF:956

Size:
6"

5 French, angled shaft,
straight atraumatic tip,
working length 80mm



Merz Suction Tube

TG-REF:957

Size:
8"

5 French, angled shaft,
angled up atraumatic tip,
working length 125mm



Merz Suction Tube

TG-REF:958

Size:
7"

5 French, angled shaft,
angled up atraumatic tip,
working length 125mm



Merz Suction Tube

TG-REF:959

Size:
8"

7 French, angled shaft,
angled down atraumatic tip,
working length 125mm



Merz Suction Tube



TAHIR GROUP OF INDUSTRIES



+92-300-6669737



TAHIR GROUP OF INDUSTRIES



TGIND.COM



TAHIR GROUP OF INDUSTRIES



tgindsale@gmail.com

140

Suction Tube

TGIND
Instruments

TG-REF:954

Size:
8"

7 French, angled shaft
angled up atraumatic tip
working length 125mm



Merz Suction Tube

TG-REF:955

Size:
8"

7 French, angled shaft
angled down atraumatic tip
working length 125mm



Merz Suction Tube

TG-REF:956

Size:
8"

10 French angled shaft
angled up atraumatic tip
working length 125mm



Merz Suction Tube

TG-REF:957

Size:
8"

10 French, angled shaft
angled down atraumatic tip
working length 125mm



Merz Suction Tube

TG-REF:958

Size:
6"

12 French, angled shaft
straight atraumatic tip
working length 80mm



Merz Suction Tube

TG-REF:959

Size:
3"

angled shaft
straight atraumatic tip
working length 180mm



Merz Suction Tube



TAHIR GROUP OF INDUSTRIES



+92-300-6669737



TAHIR GROUP OF INDUSTRIES



TGIND.COM



TAHIR GROUP OF INDUSTRIES



tgindsale@gmail.com

141

Suction Tube

TGIND
Instruments

TG-REF:960

Size:
10"
angled 45°, detachable tip



TG-REF:961

Size:
11 3/4"angled



TG-REF:962

Size:
11",angled



Vascular Suction Tube

Vascular/Thoracic Suction Tube

Vascular/Thoracic suction tube

TG-REF:963

Size:
11",angled



TG-REF:964

Size:
1.5mm diameter atraumatic tip,
angled, working length
130mm
180mm
222mm



TG-REF:965

Size:
2.0mm diameter atraumatic tip,
angled, working length
130mm
150mm
180mm
222mm



Vascular/Thoracic suction tube

Yasargil suction tube

Merz Suction Tube



TAHIR GROUP OF INDUSTRIES



+92-300-6669737



TAHIR GROUP OF INDUSTRIES



TGIND.COM



TAHIR GROUP OF INDUSTRIES



tgindsate@gmail.com

Suction Tube

TGIND
Instruments

TG-REF:967

Size:
3.5mm diameter atraumatic tip,
angled, working length
130mm
150mm
180mm
222mm



Yasargil suction tube

TG-REF:968

Size:
5 French, bayonet,
7 French, bayonet,
9 French, bayonet,
left finger control



Neuro suction tube

TG-REF:969

Size:
5 French, bayonet,
7 French, bayonet,
9 French, bayonet,
left finger control



Neuro suction tube

TG-REF:970

Size:
5 French, bayonet,
7 French, bayonet,
9 French, bayonet,
right finger control



Neuro Suction Tube

TG-REF:971

Size:
8 French, angled
14 French, angled



Sachs Brain Suction Tube

TG-REF:972

Size:
8 1/4", angled,
tapered tip to
1.0mm diameter
2.0mm diameter
3.0mm diameter
4.0mm diameter



Vascular suction tube



TAHIR GROUP OF INDUSTRIES



+92-300-6669737



TAHIR GROUP OF INDUSTRIES



TGIND.COM



TAHIR GROUP OF INDUSTRIES



tgindsale@gmail.com

143

TG-REF:973

Size:
replacement stylet, 20 gauge
replacement stylet, 22 gauge



Schuknecht suction tube

TG-REF:974

Size:
26 gauge, angled,
working length 78mm,
thumb plate
with cutoff hole



Schuknecht Suction Tube

TG-REF:975

Size:
11",
curved, 2.5mm
diameter, 4.0mm tip
curved, 4.0mm
diameter, 7.0mm tip
curved, 5.0mm
diameter, 9.0mm tip
curved, 8.0mm
diameter, 13.0mm tip



Vascular Suction Tube

TG-REF:970

Size:
replacement stylet,
24 gauge



Schuknecht Suction Tube

TG-REF:977

Size:
12 1/4", angled,
8.0mm diameter
10.0mm diameter
12.0mm diameter



Senning Vascular Suction Tube

TG-REF:978

Size:
5 3/4", short,
3 French, straight,
navy, working length 88mm



**Fukushima Teardrop
Suction Tube**



TAHIR GROUP OF INDUSTRIES



+92-300-6669737



TAHIR GROUP OF INDUSTRIES



TGIND.COM



TAHIR GROUP OF INDUSTRIES



tgindsale@gmail.com

Suction Tube

TGIND
Instruments

TG-REF:979

Size:
5 3/4",short,
4 French, straight,
Red working length 88mm



Fukushima Teardrop
Suction Tube

TG-REF:980

Size:
5 3/4",short,
5 French, straight,
Green, working length 88mm



Fukushima Teardrop
Suction Tube

TG-REF:981

Size:
5 3/4",short,
6 French, straight,
Gray, working length 88mm



Fukushima Teardrop
Suction Tube

TG-REF:982

Size:
5 3/4",short,
7 French, straight,
Gold working length 88mm



Fukushima Teardrop
Suction Tube

TG-REF:983

Size:
5 3/4",short,
8 French, straight,
Purple working length 88mm



Fukushima Teardrop
Suction Tube

TG-REF:984

Size:
5 3/4",short,
9 French, straight,
Black working length 88mm



Fukushima Teardrop
Suction Tube



TAHIR GROUP OF INDUSTRIES



+92-300-6669737



TAHIR GROUP OF INDUSTRIES



TGIND.COM



TAHIR GROUP OF INDUSTRIES



tgindsale@gmail.com

145



TG-REF:985
Size:
7",
Straight
Curved
beveled blades blunt tips

Church Artery Scissors



TG-REF:986
Size:
7 1/4",
curved blades,
blunt tips,

Cooley Cardio Scissors



TG-REF:987
Size:
7",
angled 45°
Superior-Cut blades,
sharp tips,
black ring handle

**Diethrich Coronary
Artery Scissors**



TG-REF:982
Size:
9",slightly curved,
serrated blades
, ring handle

Diethrich Valve Scissors



TG-REF:983
Size:
11",angled 45° blades,
blunt tips, ring handle

DeBakey Vascular Scissors



TG-REF:984
Size:
7",micro fine,
angled 45° blades,
angled 90° blades,
sharp tips,
round handle

**Jacobson Microsurgical
Scissors**





TG-REF:991
Size:
6 3/4",
straight rounded blades,
blunt tips, ring handle

Lincoln Vascular Scissors



TG-REF:992
Size:
4", straight blades,
ring handle

Wire Cutting Scissors



TG-REF:993
Size:
5", angled 60° blades,
sharp tips, ring handle

Peripheral Vascular Scissors



TG-REF:994
Size:
7 1/4",
angled 25° blades,
angled 45° blades,
angled 60° blades
sharp tips

Vascular/Artery Scissors



TG-REF:995
Size:
7",
Delicate angled 25° blades,
Delicate angled 45° blades,
Delicate angled 60° blades
Delicate angled 90° blades
Delicate angled 105° blades
Delicate angled 125° blades
Sharp tips

Vascular/Artery Scissors



TG-REF:996
Size:
7",
Extra Delicate angled 25°
Extra Delicate angled 45°
Extra Delicate angled 60°
Extra Delicate angled 90°
Extra Delicate angled 105°
Extra Delicate angled 125°
Sharp tips

Vascular/Artery Scissors





TG-REF:997
Size:
5 3/4",
angled 115° blades
sharp tips,
ring handle

Beall Circumflex Scissors



TG-REF:998
Size:
6 3/4",
angled 25°
angled 45°
angled 60°
angled 90°
angled 25°
delicate,
10.0mm blades,
sharp tips,

Beall Coronary Scissors



TG-REF:999
Size:
10",
delicate, straight
beveled blades,
blunt tips,
ring handle

Church artery scissors



TG-REF:1000
Size:
10",
delicate, curved
beveled blades,
blunt tips,
ring handle

Church artery scissors



TG-REF:1001
Size:
9",
angled 30° blades,
blunt tips,
ring handle

Cooley Arteriotomy Scissors



TG-REF:1002
Size:
7 1/4",
angled
30° 12.0mm blades,
blunt tips,
ring handle

Cooley Arteriotomy Scissors





TG-REF:1003
Size:
9",
10 3/4"
angled 30°
blades, blunt tips



Cooley Arteriotomy Scissors



TG-REF:1004
Size:
9"
curved blades,
blunt tips,
ring handle



Cooley Cardio Scissors



TG-REF:1005
Size:
7 1/2",
curved Superior-Cut
blades, blunt tips,
black ring handle



Cooley Cardio Scissors



TG-REF:1006
Size:
12",
curved blades,
blunt tips,
ring handle



Cooley Cardio Scissors



TG-REF:1007
Size:
6 3/4",
angled 25°,
12.0mm blades,
sharp tips,
flat handle



Coronary Artery Scissors



TG-REF:1008
Size:
6 3/4",
angled 25°,
12.0mm blades,
sharp tips,
flat handle
titanium blue



Coronary Artery Scissors



TAHIR GROUP OF INDUSTRIES



+92-300-6669737



TAHIR GROUP OF INDUSTRIES



TGIND.COM



TAHIR GROUP OF INDUSTRIES



tgindsale@gmail.com



TG-REF:1009
Size:
6 3/4", angled 25°,
12.0mm blades,
sharp tips,
with ball tip on
upper blade,
flat handle



TG-REF:1010
Size:
6 3/4", angled 45°,
12.0mm blades,
sharp tips,
with ball tip on
lower blade,
flat handle



TG-REF:1011
Size:
6 3/4",
angled 60°,
12.0mm blades,
sharp tips,
flat handle



Coronary Artery Scissors

Coronary Artery Scissors

Coronary Artery Scissors



TG-REF:1012
Size:
6 3/4",
angled 45°,
12.0mm blades,
sharp tips,
flat handle



TG-REF:1013
Size:
6 3/4",
angled 60°,
12.0mm blades,
sharp tips,
flat handle
titanium blue



TG-REF:1014
Size:
6 3/4",
angled 60°,
12.0mm blades,
sharp tips,
flat handle

Coronary Artery Scissors

Coronary Artery Scissors

Coronary Artery Scissors



TAHIR GROUP OF INDUSTRIES



+92-300-6669737



TAHIR GROUP OF INDUSTRIES



TGIND.COM



TAHIR GROUP OF INDUSTRIES



tgindsale@gmail.com



TG-REF:1015

Size:
6 3/4", angled 90°,
12.0mm blades,
sharp tips,
flat handle



Coronary Artery Scissors



TG-REF:1016

Size:
6 3/4",
angled 90°,
12.0mm blades,
sharp tips,
flat handle
titanium blue



Coronary Artery Scissors



TG-REF:1017

Size:
6 3/4",
angled 90°,
12.0mm blades,
sharp tips,
with ball tip on
lower blade
flat handle



Coronary Artery Scissors



TG-REF:1018

Size:
6 3/4", angled 120°,
12.0mm blades,
sharp tips,
flat handle



Coronary Artery Scissors



TG-REF:1019

Size:
6 3/4", angled 120°,
12.0mm blades,
sharp tips,
flat handle
titanium blue



Coronary Artery Scissors



TG-REF:1020

Size:
6 3/4", angled 120°,
12.0mm blades,
sharp tips,
with ball tip on
lower blade
flat handle



Coronary Artery Scissors



TAHIR GROUP OF INDUSTRIES



+92-300-6669737



TAHIR GROUP OF INDUSTRIES



TGIND.COM



TAHIR GROUP OF INDUSTRIES



tgindsale@gmail.com



TG-REF:1021

Size:

12",
curved blades,
blunt tips,
ring handle

Craford Lung Scissors



TG-REF:1022

Size:

7",
angled 25° blades,
sharp tips,
ring handle

**Diethrich Coronary
Artery Scissors**



TG-REF:1023

Size:

7",
angled 25°
Superior-Cut blades,
sharp tips,
black ring handle

**Diethrich Coronary
Artery Scissors**



TG-REF:1024

Size:

7"
angled 25°
Superior-Cut blades,
micro serrated
lower blade,
sharp tips,
frosted ring handle

**Diethrich Coronary
Artery Scissors**



TG-REF:1025

Size:

7",
angled 25° TC blades,
sharp tips,
gold ring handle

**Diethrich Coronary
Artery Scissors**



TG-REF:1026

Size:

7",
angled 25° TC blades,
sharp tips,
micro serrated
lower blade,
sharp tips,
gold ring handle

**Diethrich Coronary
Artery Scissors**



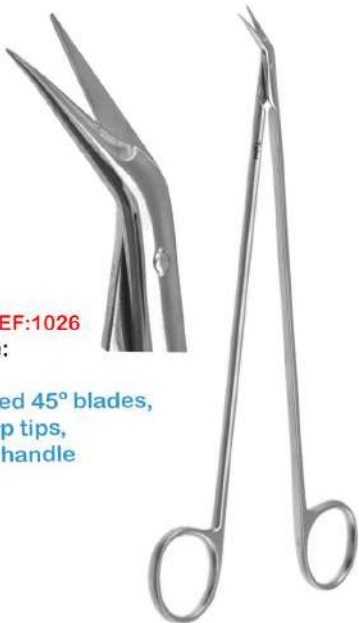

TG-REF:1026

Size:
7",
angled 45° blades,
sharp tips,
ring handle

**Diethrich Coronary
Artery Scissors**



TG-REF:1027

Size:
7",
angled 45°
Superior-Cut blades,
micro serrated
lower blade,
sharp tips,
frosted ring handle

**Diethrich Coronary
Artery Scissors**



TG-REF:1028

Size:
7",
angled 45° blades,
sharp tips,
ring handle
black ring handle

**Diethrich Coronary
Artery Scissors**



TG-REF:1029

Size:
7",angled 45°
TC blades,
micro serrated
lower blade,
sharp tips,
gold ring handle

**Diethrich Coronary
Artery Scissors**



TG-REF:1030

Size:
7",angled 45°
TC blades,
sharp tips,
gold ring handle

**Diethrich Coronary
Artery Scissors**



TG-REF:1031

Size:
7",
angled 60° blades,
sharp tips,
ring handle

**Diethrich Coronary
Artery Scissors**



TAHIR GROUP OF INDUSTRIES



+92-300-6669737



TAHIR GROUP OF INDUSTRIES



TGIND.COM



TAHIR GROUP OF INDUSTRIES



tgindsale@gmail.com



TG-REF:1032
Size:
7"
angled 60°
Superior-Cut blades,
micro serrated
lower blade,
sharp tips,
frosted ring handle

**Diethrich Coronary
Artery Scissors**



TG-REF:1033
Size:
7"
angled 60°
Superior-Cut blades
sharp tips,
black ring handle

**Diethrich Coronary
Artery Scissors**



TG-REF:1034
Size:
7"
angled 60°
TC blades,
sharp tips,
gold ring handle

**Diethrich Coronary
Artery Scissors**



TG-REF:1035
Size:
7"
angled 60°
Superior-Cut blades,
micro serrated
lower blade,
sharp tips,
frosted ring handle

**Diethrich Coronary
Artery Scissors**



TG-REF:1036
Size:
7"
angled 90° blade
sharp tips,
ring handle

**Diethrich Coronary
Artery Scissors**



TG-REF:1037
Size:
7"
angled 90°
Superior-Cut blades,
micro serrated
lower blade,
sharp tips,
frosted ring handle

**Diethrich Coronary
Artery Scissors**





TG-REF:1038
Size:
7",
angled 125° blades,
sharp tips,
ring handle,
with stabilizer bar



**Diethrich Coronary
Artery Circumflex Scissors**



TG-REF:1039
Size:
7",
angled 120° blades,
sharp tips,
ring handle



**Diethrich Coronary
Artery Scissors**



TG-REF:1040
Size:
7", angled 120°
Superior-Cut blades,
micro serrated
lower blade,
sharp tips,
frosted ring handle



**Diethrich Coronary
Artery Scissors**



TG-REF:1041
Size:
angled 120° blades,
sharp tips,
black ring handle



**Diethrich Coronary
Artery Scissors**



TG-REF:1042
Size:
7",
angled 120°
TC blades,
sharp tips,
gold ring handle



**Diethrich Coronary
Artery Circumflex Scissors**



TG-REF:1043
Size:
7",
angled 120°
TC blades,
micro serrated
lower blade,
sharp tips,
gold ring handle



**Diethrich Coronary
Artery Scissors**





TG-REF:1044
Size:
7"
angled 90°
Superior-Cut blades
sharp tips,
Titanium blue

**Diethrich Coronary
Artery Scissors**



TG-REF:1045
Size:
7"
angled 90°
Superior-Cut blades
sharp tips,
black ring handle

**Diethrich Coronary
Artery Scissors**



TG-REF:1046
Size:
7"
angled 90°
TC blades,
sharp tips,
gold ring handle

**Diethrich Coronary
Artery Scissors**



TG-REF:1047
Size:
7"
angled 90° TC
Superior-Cut blades,
micro serrated
upper blade,
sharp tips,
gold ring handle

**Diethrich Coronary
Artery Scissors**



TG-REF:1048
Size:
7"
angled 90° blades,
sharp tips,
ring handle,
with stabilizer bar
Titanium Color

**Diethrich Coronary
Artery Circumflex Scissors**



TG-REF:1049
Size:
7"
angled 90° TC
Superior-Cut blades,
sharp tips,
Titanium Gold

**Diethrich Coronary
Artery Scissors**



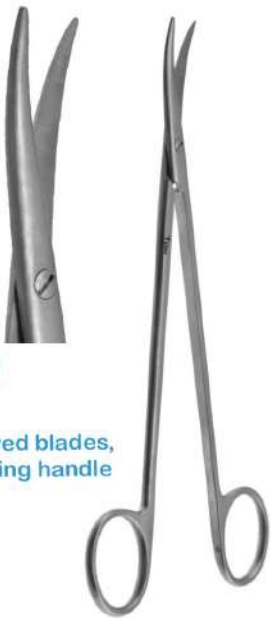

TG-REF:1050
Size:
6 3/4",
slightly curved blades,
blunt tips, ring handle

DeBakey Endarterectomy Scissors



TG-REF:1051
Size:
9", fully curved,
serrated blades,
ring handle

Diethrich Valve Scissors



TG-REF:1052
Size:
7",
fully curved blades,
blunt tips,
ring handle

DeBakey Endarterectomy Scissors



TG-REF:1053
Size:
7 1/2",
long, curved blades
blunt tips,
ring handle

DeBakey Endarterectomy Scissors



TG-REF:1054
Size:
6 3/4"
angled 25° blades,
blunt tips,
ring handle

DeBakey Vascular Scissors



TG-REF:1055
Size:
6 3/4",
angled 45° blades,
blunt tips, ring handle

DeBakey Vascular Scissors





TG-REF:1056
Size:
6 3/4", curved Superior-Cut
blades, micro serrated
lower blade, blunt tips,
frosted ring handle

Endarterectomy Scissors



TG-REF:1057
Size:
6 3/4", curved shanks,
angled 55° blades,
sharp tips, ring handle

**Favaloro Coronary
Artery Scissors**



TG-REF:1058
Size:
6 3/4", curved shanks,
delicate, angled 130°
blades, sharp tips,
ring handle

**Favaloro Coronary
Artery Scissors**



TG-REF:1059
Size:
angled 25° Superior-Cut
blades, micro serrated
lower blade,
frosted ring handle

**Hegemann Peripheral
Vascular Scissors**



TG-REF:1060
Size:
8", standard,
angled 25° blades,
sharp tips,
round handle

Jacobson Microsurgical Scissors



TG-REF:1061
Size:
8", standard,
angled 45° blades,
sharp tips,
round handle

**Jacobson Microsurgical
Scissors**





TG-REF:1062
Size:
8", standard, angled 60°
blades, sharp tips,
round handle



**Jacobson Microsurgical
Scissors**



TG-REF:1063
Size:
8", standard, angled 90°
blades, sharp tips,
round handle



**Jacobson Microsurgical
Scissors**



TG-REF:1064
Size:
8", standard, angled 120°
blades, sharp tips,
round handle



**Jacobson Microsurgical
Scissors**



TG-REF:1065
Size:
6 3/4", angled 25° on
flat 12.0mm blades,
sharp tips, flat handle



**Jacobson Microsurgical
Scissors**



TG-REF:1066
Size:
6 3/4", angled 60° on
flat 12.0mm blades,
sharp tips, flat handle



**Jacobson Microsurgical
Scissors**



TG-REF:1067
Size:
6 3/4", angled 90° on
flat 12.0mm blades,
sharp tips, flat handle



**Jacobson Microsurgical
Scissors**





TG-REF:1068
Size:
6 3/4", fine, angled 25°
blades, sharp tips,
round handle

**Jacobson Microsurgical
Scissors**



TG-REF:1069
Size:
6 3/4", fine, angled 45°
blades, sharp tips,
round handle

**Jacobson Microsurgical
Scissors**



TG-REF:1070
Size:
6 3/4", fine, angled 60°
blades, sharp tips,
round handle

**Jacobson Microsurgical
Scissors**



TG-REF:1071
Size:
6 3/4", fine, angled 60°
blades, sharp tips,
round handle

**Jacobson Microsurgical
Scissors**



TG-REF:1072
Size:
6 3/4", fine,
angled 120° blades,
sharp tips, round handle

**Jacobson Microsurgical
Scissors**



TG-REF:1073
Size:
6 1/4", nano blades,
angled 25°, sharp tips,
flat handle

**Jacobson Microsurgical
Scissors**





TG-REF:1074
Size:
10 1/4", curved,
serrated blades,
blunt tips,

Ligature Scissors



TG-REF:1075
Size:
6 3/4"
10"
curved rounded
blades, blunt tips,
ring handle

Lincoln Vascular Scissors



TG-REF:1076
Size:
10", straight rounded
blades, blunt tips,
ring handle

Lincoln Vascular Scissors



TG-REF:1077
Size:
11", angled on side shanks
, fully curved blades,
blunt tips, ring handle

Litwak Valve Scissors



TG-REF:1078
Size:
6 3/4", fine,
angled 120° blades,
sharp tips, round handle

Litwak Valve Scissors



TG-REF:1079
Size:
7", angled 25° blades,
sharp tips, flat handle

**Jacobson Microsurgical
Dissecting Scissors**





TG-REF:1080

Size:
10"
12"
straight,
serrated TC jaws,
gold ring handle



**DeBakey Vascular
Needle Holder**



TG-REF:1081

Size:
10 1/2",
curved shanks,
curved, serrated
grooved jaws,
ring handle



Johnson Needle Holder



TG-REF:1082

Size:
14", heavy, straight,
serrated TC jaws,
gold ring handle



Nolan Needle Holder,



TG-REF:1083

Size:
single-action,
5.0mm diameter,
330.0mm
working length,
straight, serrated
TC jaws,
ring handle with
ratchet catch



**In-Line Needle Holder,
Non-Rotatable**



TG-REF:1084

Size:
single-action,
5.0mm diameter,
330.0mm
working length,
Left Curved,
serrated TC jaws,
ring handle with
ratchet catch



**In-Line Needle Holder,
Non-Rotatable**



TG-REF:1085

Size:
single-action,
5.0mm diameter,
330.0mm
working length,
right Curved,
serrated TC jaws,
ring handle with
ratchet catch



**In-Line Needle Holder,
Non-Rotatable**



TAHIR GROUP OF INDUSTRIES



+92-300-6669737



TAHIR GROUP OF INDUSTRIES



TGIND.COM



TAHIR GROUP OF INDUSTRIES



tgindsale@gmail.com

Cardiovascular Needle Holder



TG-REF:1086

Size:
14"
working length 235.0mm,
3.0mm diameter shaft, curved,
fine, serrated TC jaws,
round squeeze handle



**Minimally Invasive
Heart Needle Holder**



TG-REF:1087

Size:
14"
working length 235.0mm,
5.0mm diameter shaft, curved,
fine, serrated TC jaws,
round squeeze handle



**Minimally Invasive
Heart Needle Holder**



TG-REF:1088

Size:
14"
working length 235.0mm,
3.0mm diameter shaft, straight,
fine, serrated TC jaws,
round squeeze handle



**Minimally Invasive
Heart Needle Holder**



TG-REF:1089

Size:
14"
working length 235.0mm,
5.0mm diameter shaft, straight,
fine, serrated TC jaws,
round squeeze handle



**Minimally Invasive
Heart Needle Holder**



TG-REF:1090

Size:
Short Straight jaws w/TC Inserts,
w/Lock, 5mm Shaft, 6.75" (17cm)
Working Length,
Round Squeeze Handle,
Stainless Steel, 11.75" (30cm)



**MIS Debaquey
Needle Holder**



TG-REF:1091

Size:
Curved TC Coated jaws, w/Lock,
3mm Shaft, 6.75" (17cm)
Working Length,
Round Squeeze Handle,
Stainless Steel, 11.75" (30cm)



MIS CABG Needle Holder



TAHIR GROUP OF INDUSTRIES



+92-300-6669737



TAHIR GROUP OF INDUSTRIES



TGIND.COM



TAHIR GROUP OF INDUSTRIES



info@tgind.com



TG-REF:1092
Size:
Straight jaws w/TC Inserts,
w/Lock, 5mm Shaft, 6.75"
(17cm) Working Length,
Round Squeeze Handle,
Stainless Steel, 11.75" (30cm)



**MIS Debakey
Needle Holder**



TG-REF:1093
Size:
Straight Diamond Dust jaws,
w/Lock, 5mm Shaft, 10"
(25cm) Working Length,
Round Squeeze Handle,
Stainless Steel, 14" (35.5cm)



**MIS Debakey
Needle Holder**



TG-REF:1094
Size:
Straight Dust Coated jaws,
w/Lock, 3mm Shaft,
6.75" (17cm) Working Length,
Round Squeeze Handle,
Stainless Steel, 11.75" (30cm)



**MIS CABG
Needle Holder**



TG-REF:1095
Size:
Curved Diamond Dust coated
w/Lock, 5mm Shaft, 6.75"
(17cm) Working Length,
Round Squeeze Handle,
Stainless Steel, 11.75" (30cm)



**MIS Debakey
Needle Holder**



TG-REF:1096
Size:
Curved jaws w/TC Inserts,
w/Lock, 5mm Shaft, 6.75"
(17cm) Working Length,
Round Squeeze Handle,
Stainless Steel, 11.75" (30cm)



**MIS Debakey
Needle Holder**



TG-REF:1097
Size:
Curved jaws w/TC Inserts,
w/Lock, 5mm Shaft, 11"
(28cm) Working Length,
Round Squeeze Handle,
Stainless Steel, 16" (40.5cm)



**MIS Debakey
Needle Holder**



Cardiovascular Needle Holder



TG-REF:1098
Size:
Curved jaws w/TC Inserts,
w/Lock, 5mm Shaft, 11"
(28cm) Working Length,
Round Squeeze Handle,
Stainless Steel, 16" (40.5cm)



MIS Heavy Needle Holder



TG-REF:1099
Size:
Straight Diamond Dust jaws,
w/Lock, 5mm Shaft, 10"
(25cm) Working Length,
Round Squeeze Handle,
Stainless Steel, 14" (35.5cm)



MIS Heavy Needle Holder



TG-REF:1100
Size:
Straight 2x3 DeBakey tips,
5mm Shaft, 6.75"
(17cm) Working Length,
Round Squeeze Handle,
Stainless Steel, 11.75" (30cm)



MIS DeBakey Forceps



TG-REF:1101
Size:
Straight 2x3 DeBakey tips,
5mm Shaft, 10" (25cm)
Working Length,
Round Squeeze Handle,
Stainless Steel, 14" (35.5cm)



MIS DeBakey Forceps



TG-REF:1102
Size:
Straight Atraumatic tips,
5mm Shaft, 6.75"
(17cm) Working Length,
Round Squeeze Handle,
Stainless Steel, 11.75" (30cm)



MIS Resano Forceps



TG-REF:1103
Size:
Short Straight Atraumatic tips,
5mm Shaft, 6.75"
(17cm) Working Length,
Round Squeeze Handle,
Stainless Steel, 11.75" (30cm)



MIS Resano Forceps





Size:
Straight TC coated jaws,
w/Lock, Inside spring,
Round Handle,
Stainless Steel,
5" (13cm)
TG-REF:1104

Glasser Needle Holder



Size:
Curved TC coated jaws,
w/Lock, Inside spring,
Round Handle,
Stainless Steel, 7" (18cm)
TG-REF:1105

MIS Russian Forceps



Size:
Straight jaws
w/TC inserts,
Left-Handed,
Stainless Steel,
6" (15cm)
TG-REF:1106

Microvascular Needle Holder



Size:
7 1/4",
straight,
smooth TC jaws,
flat handle,
with lock
TG-REF:1107

**Spencer Coronary
Needle Holder**

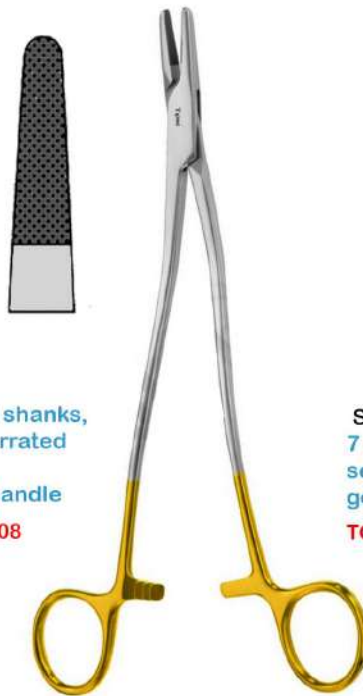

Size:
9", curved shanks,
curved, serrated
TC jaws,
gold ring handle
TG-REF:1108

Wertheim Needle Holder



Size:
7 3/4", straight,
serrated TC jaws,
gold offset ring handle
TG-REF:1109

Rubio Needle Holder



Cardiovascular Needle Holder



Size:
4 3/4",
curved shanks,
spoon curved,
2.4cm long x 8.0mm
deep serrated jaws,
ring handle
TG-REF:1110

Glasser Needle Holder



Size:
6 1/4",
straight shanks,
straight, 3.0cm
long atraumatic jaws,
ring handle
TG-REF:1111

**Cooley Patent
Ductus Clamp**



Size:
5", neonatal,
curved shanks,
angled,
3.8cm long
atraumatic jaws,
ring handle
TG-REF:1112

Cooley Vascular Carotid Clamp



Size:
5", neonatal,
curved shanks,
angled, 4.0cm
long atraumatic
jaws, ring handle
TG-REF:1113

Cooley Vascular Clamp



Size:
9", curved shanks
curved, serrated
TC jaws,
gold ring handle
TG-REF:1115

**Cooley-Derra
Anastomosis Clamp**

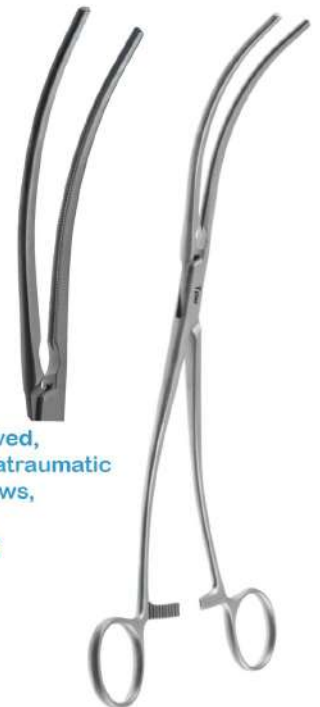

Size:
10 1/2", curved,
8.5cm long atraumatic
1x2 teeth jaws,
ring handle
TG-REF:1116

**DeBakey Aortic
Aneurysm Camp**



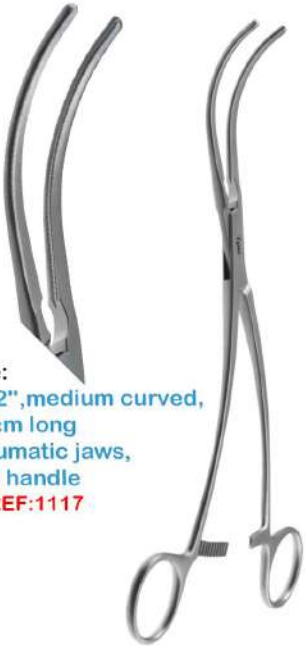

Size:
9 1/2", medium curved,
6.4cm long
atraumatic jaws,
ring handle
TG-REF:1117

DeBakey-Bahnson Clamp



Size:
6 1/4",
straight shanks,
straight, 3.0cm
long atraumatic jaws,
ring handle
TG-REF:1118

**DeBakey-Derra
Anastomosis Clamp**



Size:
8 3/4",
straight, 5.5cm
long atraumatic jaws,
ring handle
TG-REF:1119

Glover Coarctation Clamp



Size:
10 1/2",
angled shanks,
straight,
atraumatic jaws,
ring handle
TG-REF:1120

Glover Coarctation Clamp



Size:
6 3/4", small,
curved jaws,
4.0mm diameter
ring handle
TG-REF:1121

**Javid Carotid Bypass
Shunt Clamp**



Size:
6", curved shanks,
angled, 5.0cm long
serrated jaws,
ring handle
TG-REF:1122

Kartchner Carotid Clamp



Cardiovascular Clamp



Size:
7 1/2"
angled 30°
7.0cm long
atraumatic jaws,
ring handle
TG-REF:1123

Leland-Jones Peripheral Vascular Clamp



Size:
7 1/2"
angled shanks,
angled,
6.4cm long
atraumatic jaws,
ring handle
TG-REF:1124

Cooley Renal Artery Clamp

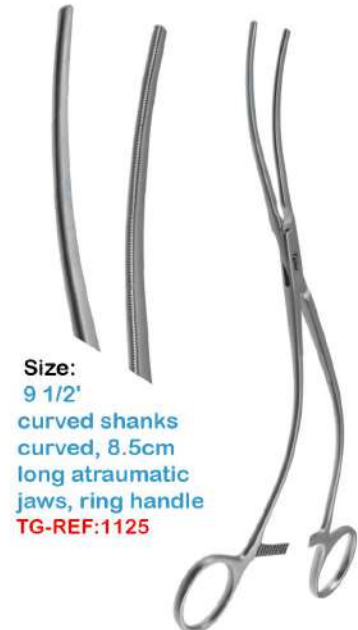

Size:
9 1/2"
curved shanks
curved, 8.5cm
long atraumatic
jaws, ring handle
TG-REF:1125

Zanger Abdominal Aorta Clamp



Size:
2 5/8", straight,
3.0cm long
atraumatic jaws,
spring handle,
adjustable
tension screw
TG-REF:1126

Cooley Bulldog Clamp



Size:
3 1/8", curved,
4.0cm long
atraumatic jaws,
spring handle,
adjustable
tension screw
TG-REF:1127

Cooley Bulldog Clamp



Size:
3 3/4"
curved,
4.5cm long
atraumatic jaws,
cross-action handle
TG-REF:1128

DeBakey Bulldog Clamp



Size:
5 1/8",
curved shanks,
angled 45°,
4.0cm long
atraumatic jaws,
ring handle
TG-REF:1129

DeBakey Bulldog Clamp



Size:
9 1/4"
angled 60°,
4.0cm long
atraumatic jaws,
ring handle
TG-REF:1130

DeBakey Multi-Purpose Clamp



Size:
9 1/2"
angled 60°
6.5cm long
atraumatic jaws,
ring handle
TG-REF:1131

**DeBakey Clamp
Multi-Purpose**



Size:
4 1/2",
straight,
4.4cm long
atraumatic jaws,
cross-action handle
TG-REF:1132

**Gregory inSoft"
Bulldog Clamp**



Size:
4 3/4",
curved left,
atraumatic jaws,
cross-action handle
TG-REF:1133

**Gregory "Soft"
Bulldog Clamp**



Size:
4 3/4"
curved right
atraumatic jaws
cross-action handle
TG-REF:1134

**Gregory "Soft"
Bulldog Clamp**



Cardiovascular Clamp



Size:
1 1/2" straight,
atraumatic
serrated jaws,
cross-action handle
TG-REF:1135

**Johns Hopkins Bulldog
Clamp**



Size:
1 1/2"
curved, atraumatic
serrated jaws,
cross-action handle
TG-REF:1136

**Johns Hopkins Bulldog
Clamp**



Size:
2"
curved, atraumatic
serrated jaws,
cross-action handle
TG-REF:1137

**Johns Hopkins Bulldog
Clamp**



Size:
straight jaws,
slight incurved tips,
for vein or artery
diameter size 1.0mm
2.25mm, ebonized finish
TG-REF:1138

**Microsurgical Artery
Approximator Clamps,
With Frame**



Size:
straight jaws
slight incurved tips
for vein or artery
diameter size 0.4mm
1.0mm, ebonized finish
TG-REF:1139

**Microsurgical Artery
Approximator Clamps,
Without Frame**



Size:
slight incurved tips,
for vein or artery
diameter size 0.4mm - 1.0mm,
ebonized finish,
sold as a pair
TG-REF:1140

**Microsurgical Artery
Clamps Single Clamps
Straight Jaws**

Cardiovascular Clamp



Size:
slight incurved tips
for vein or artery
diameter size 0.6mm
- 1.5mm, matte finish,
sold as a pair
TG-REF:1141

**Microsurgical Artery Clamps
Single Clamps,
Straight Jaws**



Size:
straight jaws,
for vein or artery
diameter
size 1.5mm - 3.5mm,
ebonized finish
TG-REF:1142

**Microsurgical Hand Applied
Approximator Clamps
Without Frame**



Size:
for vein or artery
diameter size 1.5mm - 3.5mm,
matte finish, sold as a pair
TG-REF:1143

**Microsurgical Hand Applied
Single Clamps
Straight Jaws**



Size:
for vein or artery
diameter size 1.5mm - 3.5mm,
matte finish, sold as a pair
titanium coated
TG-REF:1145

**Microsurgical Hand Applied
Single Clamps
Straight Jaws**



Size:
straight jaws
slight incurved tips
for vein or artery
diameter size 0.4mm
1.0mm, titanium coated
TG-REF:1146

**Microsurgical Artery
Approximator Clamps,
Without Frame**



Size:
slight incurved tips,
for vein or artery
diameter size 0.4mm - 1.0mm,
ebonized finish,
sold as a pair titanium coated
TG-REF:1147

**Microsurgical Artery
Clamps Single Clamps
Straight Jaws**





Size:
10 1/4"
curved shanks
angled, 3.2cm
long x 9.0mm
deep cross-serrated
jaws, ring handle
TG-REF:1148

**Satinsky Vena Cava
Clamp**



Size:
7 1/2"
angled shanks,
angled,
6.4cm long
atraumatic jaws,
ring handle
TG-REF:1149

**Crafoord (Coller)
Artery Clamp Forceps**



Size:
9 1/2"
curved shanks
curved, 8.5cm
long atraumatic
jaws, ring handle
TG-REF:1150

**Gregory Suture Stay
Clamp Forceps**

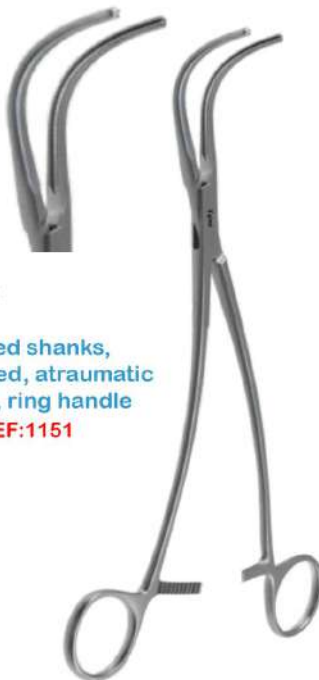

Size:
9",
angled shanks,
curved, atraumatic
jaws, ring handle
TG-REF:1151

Bahnon Aortic Clamp



Size:
8"
1)angled shanks,
angled, 3.0cm
2)long x 8.0mm
angled, 4.5cm
3)long x 8.0mm
angled, 5.5cm
long x 8.0mm
deep atraumatic jaw
ring handle
TG-REF:1152

Bailey Aorta Clamp



Size:
8"
8 1/4"
6.0cm long
6.7cm long
acutely angled
atraumatic jaws
ring handle
TG-REF:1153

Beck Aorta Clamp





Size:
6",
large
small
curved,
2.5cm long
3.0cm long
atraumatic jaws
ring handle
TG-REF:1154

Beck-Cooley Vascular Clamp



Size:
6 3/4",
angled, 2.5cm
long x 6.0mm deep
atraumatic jaws.
ring handle
TG-REF:1155

Beck Miniature Aorta Clamp



Size:
4 1/4"
angled shanks
angled, thin
3.0cm long x 6.0mm
deep serrated jaws
ring handle
TG-REF:1156

Calman Carotid Clamp



Size:
6"
small curved shanks
curved, 1.5cm long x 5.0mm
medium curved shanks
curved, 1.8cm long x 6.0mm
large curved shanks
curved, 2.1cm long x 7.0mm
deep serrated jaws
ring handle
TG-REF:1160

Castaneda Anastomosis Clamp



Size:
5"
curved shanks,
angled 90°, 3.5cm
long serrated jaws,
ring handle
TG-REF:1161

**Castaneda Multi-Purpose
Clamp**



Size:
5"
curved shanks,
angled 30°, 3.5cm long
serrated jaws,
ring handle
TG-REF:1162

**Castaneda Multi-Purpose
Clamp**



Size:
5"
neonatal
curved shanks
straight
3.5cm long
serrated jaws
ring handle
TG-REF:1163



Castaneda Multi-Purpose Clamp

Size:
5"
straight shanks,
spoon curved,
serrated jaws,
ring handle
TG-REF:1164



Castaneda Clamp

Size:
12",
angled 60° shanks,
curved, atraumatic
2x3 teeth jaws,
ring handle
TG-REF:1165



Cherry Supraceliac Clamp

Size:
9 5/8"
large, angled left,
atraumatic jaws,
ring handle
TG-REF:1166



Cleveland Cunic Renal Clamp

Size:
9 5/8"
large, angled right
atraumatic jaws
ring handle
TG-REF:1167



Cleveland Cunic Renal Clamp

Size:
6 1/2"
1) standard, angled
2.0cm long x 6.0mm
2) angled shanks,
angled, 1.9cm long
x 7.3mm deep
3) side angled 30°,
1.8cm long x 7.0mm
4) angled, calibrated,
2.2cm x 7.0mm
5) angled, calibrated
deep atraumatic jaws
ring handle
TG-REF:1168



Cooley Anastomosis Clamps





Size:
7 1/2"
curved shanks
slightly curved
6.4cm long
atraumatic jaw
ring handle
TG-REF:1169

Cooley Aortic Clamp



Size:
8"
10"
curved/angled,
7.5cm long x 1.7cm
pediatric, curved shanks,
angled, 4.7cm long X 1.3cm
deep atraumatic jaws,
ring handle
TG-REF:1170

Cooley Aorta Clamp



Size:
10 1/4"
curved,
7.6cm
atraumatic jaws
ring handle
TG-REF:1171

**Cooley Aortic Aneurysm
Clamp**



Size:
9 1/2"
curved shanks
angled
4.9cm long x 1.3cm
deep atraumatic jaws
ring handle
TG-REF:1172

**Cooley Auricular Appendage
Forceps**



Size:
6 1/2"
1) large, acutely curved,
4.5cm long x 2.0cm
2) medium, acutely curved
3.8cm long x 1.5cm
deep atraumatic jaws,
ring handle
TG-REF:1173

Cooley Aorta Clamp



Size:
5 1/4"
pediatric,
straight,
3.0cm long
atraumatic jaws,
ring handle
TG-REF:1175

Cooley Clamp





Size:
5 1/4"
pediatric,
spoon curved,
3.3cm long
atraumatic jaws,
ring handle
TG-REF:1176

Cooley Clamp



Size:
5 1/4"
pediatric
angled 25°
3.0cm long
atraumatic jaws
ring handle
TG-REF:1177

Cooley Clamp



Size:
10 1/4"
curved,
7.6cm
atraumatic jaws
ring handle
TG-REF:1178

Cooley Clamp



Size:
5 1/4"
pediatric, angled
3.3cm long x 5.0mm
deep atraumatic jaws
ring handle
TG-REF:1179

Cooley Clamp



Size:
6 3/4",
straight
shanks, straight
4.0cm long
atraumatic jaws
ring handle
TG-REF:1180

Cooley Coarctation Clamp



Size:
6 3/4"
spoon curved
5.0cm long
atraumatic jaws
ring handle
TG-REF:1181

Cooley Coarctation Clamp





Size:
6 3/4"
8 3/4"
1) 4.0cm long
2) 5.5cm long
angled shanks
straight
atraumatic jaws
ring handle
TG-REF:1182

Cooley Coarctation Clamps



Size:
6 3/4"
8 3/4"
1) 4.0cm long
2) 5.5cm long
straight shanks
straight
atraumatic jaws
ring handle
TG-REF:1183

Cooley Coarctation Clamp



Size:
1) 8 1/2"
5.5cm long
2) 10"
6.6cm long
angled shanks
straight
atraumatic jaws
ring handle
TG-REF:1184

Cooley Lliac Clamp



Size:
6 1/2"
angled 30°
3.2cm long
atraumatic jaws
ring handle
TG-REF:1185

**Cooley Multi-Purpose
Clamp**



Size:
6 3/4",
straight
shanks, straight
4.0cm long
atraumatic jaws
ring handle
TG-REF:1186

**Cooley Multi-Purpose
Clamp**



Size:
5 1/2"
angled 90°,
3.2cm long
atraumatic jaws,
ring handle
TG-REF:1187

**Cooley Multi-Purpose
Clamp**





Size:
6 3/4"
8 3/4"
1) 4.0cm long
2) 5.5cm long
angled shanks
straight
atraumatic jaws
ring handle
TG-REF:1189

Cooley Multi-Purpose Clamp



Size:
8"
1) 3.2cm long x 1.6cm
2) 3.8cm long x 1.9cm
curved, calibrated
deep atraumatic jaws
ring handle
TG-REF:1190

Cooley Multi-Purpose Clamp



Size:
1) 8 1/2"
5.5cm long
2) 10"
6.6cm long
angled shanks
straight
atraumatic jaws
ring handle
TG-REF:1191

Cooley Lliac Clamp



Size:
5 1/2"
angled 90°, 25.0mm long
angled 90°, 17.0mm long
angled 90°, 35.0mm long
long atraumatic jaws
ring handle
TG-REF:1192

Cooley Multi-Purpose Clamp



Size:
6 3/4",
straight
shanks, straight
4.0cm long
atraumatic jaws
ring handle
TG-REF:1193

Cooley Occlusion Clamp



Size:
1) 7 3/4"
angled 2.2cm
long x 7.0mm
2) 8 1/2"
angled, 3.5cm
long x 8.0mm
deep atraumatic
jaws, ring handle
TG-REF:1194

Cooley Partial Occlusion Clamp





Size:
6 1/4"
angled shanks,
straight, 3.0cm
long atraumatic
jaws, ring handle
TG-REF:1195

Cooley Patent Ductus Clamp



Size:
8"
straight shanks
straight,
3.0cm long,
atraumatic jaws,
ring handle
TG-REF:1196

Cooley Patent Ductus Clamp



Size:
6 1/2"
angled 55°,
3.5cm long
atraumatic jaws
ring handle
TG-REF:1197

**Cooley Peripheral
Vascular Clamp**



Size:
6 1/2"
curved, 3.0cm
long atraumatic
jaws, ring handle
TG-REF:1198

**Cooley Peripheral
Vascular Clamp**



Size:
6 3/4"
1)angled 55°
4.5cm
2)angled 45°
4.5cm
3)angled 55°
6.0cm
long atraumatic jaws
ring handle
TG-REF:1199

**Cooley Peripheral
Vascular Clamp**



Size:
6 3/4"
straight, 4.5cm
long atraumatic jaws
ring handle
TG-REF:1200

**Cooley Peripheral
Vascular Clamp**





Size:
5 3/4"
angled 15°
Angled 30°
angled 45°
atraumatic jaws
ring handle
TG-REF:1201

**Dardik Multi-purpose
Clamp**



Size:
5 3/4"
straight
atraumatic jaws
ring handle
TG-REF:1202

**Dardik Multi-purpose
Clamp**



Size:
5 3/4"
angled 90°
atraumatic jaws
ring handle
TG-REF:1203

**Dardik Multi-purpose
Clamp**



Size:
1) 10 1/2"
angled/curved
5.0cm long
2) 9"
angled/curved
5.5cm long
atraumatic jaws
ring handle
TG-REF:1204

**DeBakey inSidewinder
Aorta Clamp**



Size:
7 1/4"
curved shanks
curved, 7.6cm
long atraumatic
jaws, ring handle
TG-REF:1205

**DeBakey Aortic Exclusion
Clamp**



Size:
9 1/2"
curved, 7.5cm
long atraumatic
1x2 teeth jaws
ring handle
TG-REF:1206

**DeBakey Aortic Aneurysm
Clamp**





Size:
8"
angled, 3.8cm
long x 6.0mm
deep atraumatic
jaws, ring handle
TG-REF:1207

**Cooley Vena Cava
Clamp**



Size:
6 1/2"
small, angled,
2.0cm long x 9.0mm deep
medium, angled,
2.9cm long x 11.0mm deep
atraumatic jaws
ring handle
TG-REF:1208

**Cooley-Derra Anastomosis
Clamp**



Size:
9 1/4"
curved, 7.0mm long
atraumatic 2x3 teeth jaws
ring handle
TG-REF:1209

**Crafoord Coarctation
Vascular Clamp**



Size:
1) 13"
angled shanks
curved, atraumatic
ring handle
2) 14"
curved, atraumatic
ring handle
TG-REF:1210

**Crawford Thoraco/abdominal
Aneurysm Clamp**



Size:
1) 6 3/4"
small, angled, 1.3cm
2) 6 3/4"
medium, angled, 1.9cm
3) 7 1/4"
large, angled, 2.5cm
long atraumatic jaws,
ring
TG-REF:1211

**Dale inFem-Pop"
Anastomosis
Clamp**

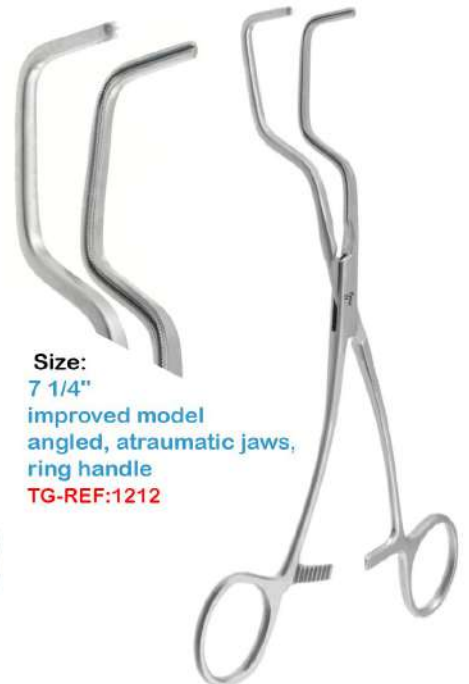

Size:
7 1/4"
improved model
angled, atraumatic jaws,
ring handle
TG-REF:1212

**Dale inFem-Pop"
Anastomosis
Clamp**





Size:
5 3/4"
angled 15°
Angled 30°
angled 45°
atraumatic jaws
ring handle
TG-REF:1213

**Dardik Multi-purpose
Clamp**



Size:
5 3/4"
straight
atraumatic jaws
ring handle
TG-REF:1214

**Dardik Multi-purpose
Clamp**



Size:
5 3/4"
angled 90°
atraumatic jaws
ring handle
TG-REF:1215

**Dardik Multi-purpose
Clamp**



Size:
1) 10 1/2"
angled/curved
5.0cm long
2) 9"
angled/curved
5.5cm long
atraumatic jaws
ring handle
TG-REF:1216

**DeBakey inSidewinder
Aorta Clamp**



Size:
7 1/4"
curved shanks
curved, 7.6cm
long atraumatic
jaws, ring handle
TG-REF:1217

**DeBakey Aortic Exclusion
Clamp**



Size:
1) 9 1/2" 8.6cm
long atraumatic
fully curved
8.6cm long atraumatic
1x2 teeth jaws
3) clamp, 12"
curved, 10.0cm
long atraumatic 2x3
4) clamp, 13"
curved, 12.0cm
long atraumatic 2x3
ring handle
TG-REF:1218

**DeBakey Aortic Aneurysm
Clamp**





Size:
1) 6 3/4" actulay curved
2) 9 5/8" small actulay curved
3) 10" large actulay curved 7.0cm long
TG-REF:1219

DeBakey Clamp

Size:
1) 9" straight 5.5cm long atraumatic jaws
2) 9" angled shanks straight, 5.5cm atraumatic jaws
3) 6 1/2" straight 4.5cm long atraumatic jaws
TG-REF:1220



DeBakey Coarctation Clamp

Size:
6 1/2" angled shanks straight 4.5cm long atraumatic jaws
TG-REF:1221



DeBakey Mini Coarctation Clamp



Size:
6 1/4" straight pediatric atraumatic jaws ring handle
TG-REF:1222

DeBakey Patent Ductus Clamp



Size:
6 1/4" angled shanks straight pediatric atraumatic jaws ring handle
TG-REF:1223

DeBakey Patent Ductus Clamp



Size:
6 3/4" pediatric spoon curved atraumatic jaws ring handle
TG-REF:1224

DeBakey Patent Ductus Clamp





Size:
10"
curved shanks
angled atraumatic
jaws, ring handle
TG-REF:1225

DeBakey Renal Artery Clamp



Size:
8"
curved shanks,
curved, 7.6cm
long atraumatic jaws
ring handle
TG-REF:1226

DeBakey Peripheral Vascular Clamp

Size:
1) 7 3/4"
angled, 3.5cm
long x 11.0mm deep
2) 9 3/4"
angled, 4.8cm
long x 16.0mm
3) 10"
angled, 5.5cm
long x 15.0mm deep
4) 10"
angled, 6.0cm
long x 14.0mm deep
5) 11"
angled, 7.5cm
long x 17.0mm deep
atraumatic jaws
ring handle
TG-REF:1227



DeBakey Tangential Occlusion Clamp



Size:
1) 9"
acute curved
6.0cm long
2) 9 1/2"
medium curved
3) 10"
slightly curved,
7.6cm long
atraumatic jaws
ring handle
TG-REF:1228

DeBakey-Bahnson Clamp



Size:
1) 6 3/4"
curved, 4.0cm
2) 7"
curved 6.0cm long
3) 7 7/8"
straight, 6.0cm long
atraumatic jaws
TG-REF:1229

DeBakey-Bainbridge Vascular Clamp

Size:
1) 4 3/4"
curved shanks
angled #1, 1.4mm wide
2) 4 3/4"
curved shanks
angled #2 1.4mm wide
3) 4 3/4"
curved shanks,
angled #3, 1.4mm wide
4) 4 3/4" curved shanks
angled, 1.4mm wide
TG-REF:1230

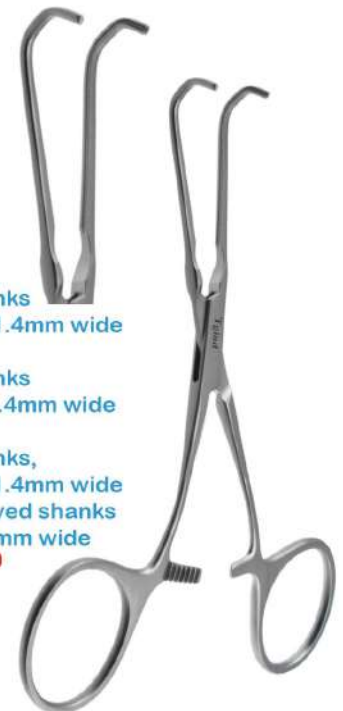

DeBakey-Castaneda Anastomosis Clamp





Size:
4 3/4"
curved shanks, angled
1.4mm wide atraumatic
jaws, ring handle
TG-REF:1231

DeBakey-Castaneda Clamp



Size:
4 3/4"
straight shanks,
straight, 1.4mm wide
atraumatic jaws
ring handle
TG-REF:1232

DeBakey-Castaneda Clamp



Size:
4 3/4"
curved shanks
straight, 1.4mm wide
atraumatic jaws, ring
TG-REF:1233

DeBakey-Castaneda Clamp



Size:
4 3/4"
curved shanks
acute curved, 1.4mm
wide atraumatic jaws,
ring handle
TG-REF:1234

DeBakey-Castaneda Clamp



Size:
4 3/4"
curved shanks
slightly curved
1.4mm wide
atraumatic jaws
ring handle
TG-REF:1235

DeBakey-Castaneda Clamp



Size:
4 3/4"
curved shanks
curved, 1.4mm
wide atraumatic jaws
ring handle
TG-REF:1236

DeBakey-Castaneda Clamp





Size:
4 3/4"
curved shanks
angled 45°
1.4mm wide
atraumatic jaws
ring handle
TG-REF:1237

DeBakey-Castaneda Clamp



Size:
4 3/4"
curved shanks
angled 90°
1.4mm wide
atraumatic jaws
ring handle
TG-REF:1238

DeBakey-Castaneda Clamp



Size:
6 1/2"
1)small, angled
1.5cm long x 9.0mm deep
3)large, angled, 2.5cm long
x 15.0mm deep
atraumatic jaws
ring handle
TG-REF:1239

**DeBakey-Derra Anastomosis
Clamp**



Size:
7 3/4"
1)small, angled,
20.0mm long x 14.0mm deep
2)medium, angled, 25.0mm
long x 16.0mm deep
3)large, angled, 28.0mm
long x 15.0mm deep
longitudinal serrated
jaws, ring handle
TG-REF:1240

Derra Vena Cava Clamp



Size:
8 1/4"
angled shanks
straight, atraumatic
jawsring handle
TG-REF:1241

Demos Tibial Artery Clamp



Size:
10 1/4"
curved, 5.7cm long jaws
1.5cm long atraumatic
serrations ring handle
TG-REF:1242

**DeBakey-Semb Ligature
Carrier Clamp**



Size:
6"
curved shanks
angled, thin
3.0cm long x 8.0mm deep
serrated jaws
ring handle
TG-REF:1243



Example Carotid Clamp

Size:
11"
1) half curved
2) fully curved
atraumatic jaws
ring handle
TG-REF:1244



Favaloro-Semb Ligature Carrier Clamp

Size:
1) 9 3/4"
curved, 7.5cm
2) 12"
curved, 10.0cm
3) 12 1/4"
curved, 12.0cm
atraumatic jaws
TG-REF:1245



Fitzgerald Aortic Aneurysm Clamp

Size:
5"
angled jaws
ring handle
TG-REF:1246



**Fogarty Safe Jaw Clamp
TC**

Size:
6 1/2"
straight jaws
ring handle
TG-REF:1247



**Fogarty Safe Jaw Clamp
TC**

Size:
8 1/2"
curved shanks
angled jaws
ring handle
TG-REF:1248



**Fogarty Safe Jaw Clamp
TC**





Size:
9"
angled
4.7cm long x 7.0mm
deep atraumatic jaws
ring handle
TG-REF:1249

Glover Atrial Appendage Clamp



Size:
8 1/2"
spoon curved,
6.2cm long
atraumatic jaws
ring handle
TG-REF:1250

Glover Anastomosis Clamp



Size:
1) 7 1/4"
curved
right angled
4.0cm long
2) 8" right angled
4.0cm long
8 1/4" standard
curved, 4.5cm
3) 9 1/2" long,
curved, 5.7cm
atraumatic jaws
ring handle
TG-REF:1251

Glover Clamps



Size:
1) 8 3/4"
angled shanks
straight, 5.5cm
2) 10 1/2"
angled shanks
straight, 7.5cm
TG-REF:1252

Glover Coarctation Clamp



Size:
1) 8 3/4"
straight, 5.5cm
2) 10 1/2"
straight, 7.5cm
TG-REF:1253

Glover Coarctation Clamp



Size:
8 1/2"
curved
5.0cm long
atraumatic jaws
ring handle
TG-REF:1254

Glover Cooley Clamp





Size:
8 3/4"
angled shanks
straight, 5.5cm
long atraumatic jaws
ring handle
TG-REF:1255

Glover Coarctation Clamp



Size:
10 1/2"
straight
atraumatic jaws
ring handle
TG-REF:1256

Glover Coarctation Clamp



Size:
1) 9 1/2"
long
spoon curved
5.3cm
2) 10 1/2"
straight
atraumatic jaws
ring handle
TG-REF:1257

Glover Clamps



Size:
1) 8 1/2"
curved, 5.0cm
2) 9 1/2",
curved, 7.0cm
TG-REF:1258

Glover Cooley Clamp



Size:
1) 8"
angled shanks
straight
3.0mm long
atraumatic jaws
ring handle
TG-REF:1259

**Glover Patent Ductus
Clamp**



Size:
1) 9 1/2"
angled shanks
curved
4.5cm long
atraumatic
2) 10 1/2"
angled shanks
curved, 6.4cm
2x3 teeth jaws
ring handle
TG-REF:1260

**Grant Abdominal Aorta
Clamp**





Size:
4 5/8"
angled, 6.4cm
long atraumatic
jaws, 12.0mm distal tip
cross-action handle
TG-REF:1255

**Gregory Carotid Bulldog
Clamp**



Size:
4 3/4"
angled 45°, 7.0cm
long atraumatic jaws
cross-action handle
TG-REF:1256

**Gregory Internal Carotid
Bulldog Clamp**



Size:
1) 5"
extra small
angled/curved
atraumatic jaws
ring handle
2) 6 1/2"
small, angled/curved
4.4cm atraumatic jaws
ring handle
TG-REF:1257

Gregory Profunda Clamp



Size:
1) 7 1/2"
large
angled/curved
2) 7"
medium
angled/curved
6.2cm atraumatic
jaws, ring handle
TG-REF:1258

Gregory Profunda Clamp



Size:
1) 10", #1, curved
2) 10", #2, curved,
4.8cm long
3) 10", #3, curved,
6.4cm long
4) 10", #4, curved,
atraumatic jaws
TG-REF:1259

Harken Auricle Clamp



Size:
8"
double angled
7.0cm long
TG-REF:1260

**Henly Subclavian Artery
Clamp**





Size:
4 5/8"
angled, 6.4cm
long atraumatic
jaws, 12.0mm distal tip
cross-action handle
TG-REF:1261

**Howard-DeBakey Aortic
Aneurysm Clamp**



Size:
4 3/4"
angled 45°, 7.0cm
long atraumatic jaws
cross-action handle
TG-REF:1262

**Howard-DeBakey Aortic
Aneurysm Clamp**



Size:
7 1/8"
small,
curved jaws,
6.0mm diameter
ring tips
TG-REF:1263

**Javid Carotid Bypass
Shunt Clamp**



Size:
8"
angled shanks
curved, 4.5cm
wide x 1.9cm
deep atraumatic
jaws, ring handle
TG-REF:1264

**Kay Aortic Anastomosis
Clamp**

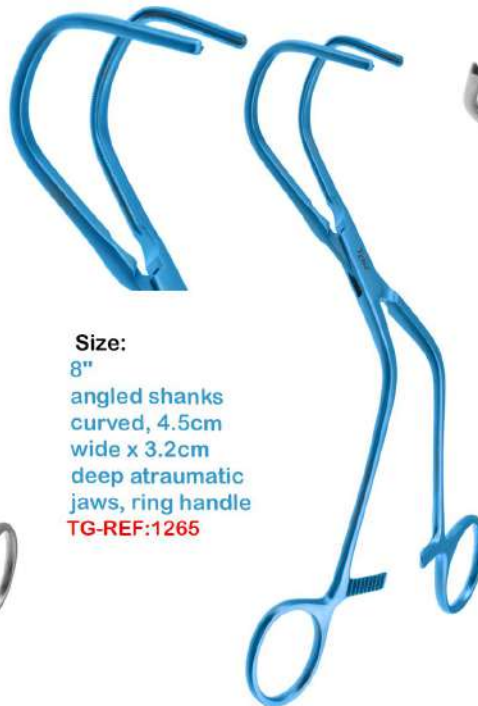

Size:
8"
angled shanks
curved, 4.5cm
wide x 3.2cm
deep atraumatic
jaws, ring handle
TG-REF:1265

**Kay Aortic Anastomosis
Clamp**



Size:
5 1/2"
angled left
2.3cm long
atraumatic jaws
ring handle
TG-REF:1266

Kitzmiller-Cooley Clamp



Size:
5 1/2"
angled left
2.3cm long
atraumatic jaws
ring handle
TG-REF:1267

Kitzmiller-Cooley Clamp



Size:
5 1/2"
angled right
2.3cm long
atraumatic jaws
ring handle
TG-REF:1268

Kitzmiller-Cooley Clamp



Size:
5 1/2"
angled right
2.3cm long
atraumatic jaws
ring handle
TG-REF:1269

Kitzmiller-Cooley Clamp



Size:
8 1/4"
angled shanks
curved, atraumatic
jaws, ring handle
TG-REF:1270

**Lambert-Kay Aortic Anastomosis
Clamp**



Size:
1) 8 1/2"
right angled
2) 9 1/4"
curved shanks
double angled
atraumatic jaws
ring handle
TG-REF:1271

Lee Bronchus Clamp



Size:
1) 7 1/2"
straight
7.0cm long
2) angled 15°
7.0cm long
atraumatic jaws
ring handle
TG-REF:1272

**Leland-Jones Peripheral
Vascular Clamp**



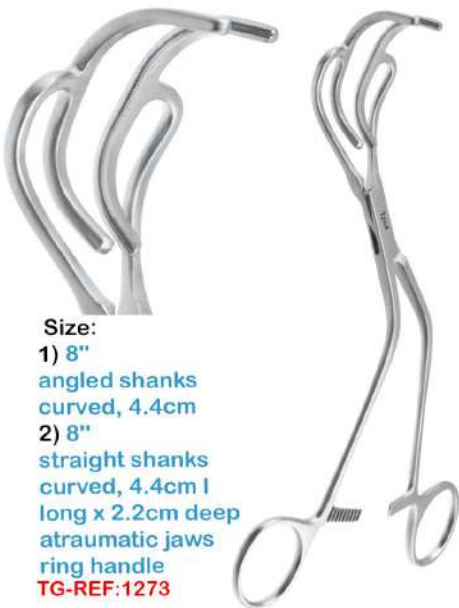

Size:
1) 8"
angled shanks
curved, 4.4cm
2) 8"
straight shanks
curved, 4.4cm l
long x 2.2cm deep
atraumatic jaws
ring handle
TG-REF:1273

Lemole-Strong Aorta Clamp



Size:
1) 8 1/4"
angled, 6.4cm
2) 10"
angled, 7.0cm
long atraumatic 2x3
teeth jaws, ring handle
TG-REF:1274

**Morris Ascending Aorta
Clamps**



Size:
4 3/4"
pediatric straight
shanks straight
atraumatic jaws
ring handle
titanium
TG-REF:1275

Microvascular Clamp



Size:
4 3/4"
pediatric
straight shanks
1) angled 45°
2) angled 60°
atraumatic jaws
ring handle
titanium
TG-REF:1276

Microvascular Clamps



Size:
4 3/4"
pediatric
straight shanks
angled, 6.0mm
atraumatic jaws
ring handle
titanium
TG-REF:1277

Microvascular Clamps



Size:
4 3/4"
pediatric
slightly angled
shanks, straight
atraumatic jaws
ring handle
titanium
TG-REF:1278

Microvascular Clamps



Size:
10 3/8"
angled shanks
angled
atraumatic jaws
ring handle
TG-REF:1279

Ochsner Classic Aorta Clamp

Size:
10 1/4"
1) angled, 2.9cm
2) angled, 3.2cm
3) angled, 3.8cm
4) angled, 4.5cm
angled shanks
long atraumatic jaws
ring handle
TG-REF:1280



Parsonnet Aorta Clamp

Size:
7 1/2"
1) angled, 7.5cm
2) angled, 9.0
long atraumatic jaws
ring handle
TG-REF:1281



Cooley Renal Artery Clamp



Size:
6 1/2"
1) small, angled 85°
2.9cm long x 5.0mm
2) large, angled 85°
3.6cm long x 6.0mm
deep atraumatic jaw
ring handle
TG-REF:1282

Reynolds Vascular Clamp



Size:
5 1/2"
Pediatric Angled
2.5cm long x 5.0mm
deep atraumatic jaws
ring handle
TG-REF:1283

Satinsky-Cooley Clamp

Size:
4 3/4"
pediatric
slightly angled
shanks, straight
atraumatic jaws
ring handle
titanium
TG-REF:1284



Microvascular Clamps



Orthopedic Mallet

TGIND
Instruments



Size:
20cm
Head Dia 38mm
/Weight 4oz
TG-REF:A-1279

Kirk Mallet



Size:
19cm
Head Dia 25mm
/Weight 10oz
TG-REF:A-1280

Gergoz Mallet



Size:
19cm
Head Dia 40mm
/Weight 8oz
TG-REF:A-1281

Heath Mallet



Size:
19cm
for ulnar head
prosthesis
TG-REF:A-1282

Herbert Mallet



Size:
19cm
with interchangeable
plastic disks
TG-REF:A-1283

Mead Mallet



Size:
28cm
Head Dia 38mm/24mm
Weight 906gm
TG-REF:A-1284

He-Man Mallet



TAHIR GROUP OF INDUSTRIES



+92-300-6669737



TAHIR GROUP OF INDUSTRIES



TGIND.COM



TAHIR GROUP OF INDUSTRIES



info@tgind.com

195-A

Bone Holding Forceps

TGIND
Instruments



Size:
14cm
TG-REF:B-1285

Bone Reduction Forceps



Size:
18.5cm
TG-REF:B-1286

Lewin Bone Holding Forceps



Size:
14cm
TG-REF:B-1287

Bone Holding Forceps Delicate



Size:
18cm
TG-REF:B-1288

Self Centering Bone Holding Forceps



Size:
17.5cm
25cm
26cm
27cm
TG-REF:B-1289

Verbrugge Lowman Bone Holding Forceps



Size:
12cm
14cm
18cm
20cm
22cm
TG-REF:B-1290

Gerster-Lowman Bone Holding Clamp

Orthopedic Chisels

TGIND
Instruments

Size:
6 mm
8 mm
10 mm
12 mm
14 mm
16 mm
TG-REF:C-1291



Cinelli Osteotome Chisel

Size:
15cm
TG-REF:C-1292



Hajek Septum Chisel

Size:
5-1/2"
TG-REF:C-1293



Hoke Osteotome

Size:
18cm
TG-REF:C-1294



Alexander Bone Chisel

Size:
Concave / Straight
8" 8"
10mm 10mm
16mm 16mm
19mm 19mm
26mm 26mm
TG-REF:C-1295



Smith Peterson Gouge

Size:
Curve Down (top)
Sharp Curve
Medium Curve
Straight Curve (bottom)
TG-REF:C-1296



Cobb Spinal Gouges

Amputation Saw

TGIND
Instruments



Size:
35cm
TG-REF:D-1297

Charriere Amputation Saw



Size:
29cm
TG-REF:D-1298

Satterlee Amputation Saw



Size:
27cm
TG-REF:D-1299

Carriere Amputation Saw



Size:
23cm
TG-REF:D-1300

Satterlee Amputation
Saw



Size:
40.5cm
TG-REF:D-1301

Bier Amputation
Saw



Size:
24.5cm
TG-REF:D-1302

Langenback Amputation
Saw

Size:
2.5"
TG-REF:D-1303



Cast Cutter Blade
Saw



TAHIR GROUP OF INDUSTRIES



+92-300-6669737



TAHIR GROUP OF INDUSTRIES



TGIND.COM



TAHIR GROUP OF INDUSTRIES



info@tgind.com

195-D



Size:
20cm
TG-REF:E-1304

Bone Hook T Handle



Size:
29cm
TG-REF:E-1305

Gili Saw Handles Solid



Size:
23cm
TG-REF:E-1306

Bone Hook



Size:
30cm
TG-REF:E-1307

Percy Amputation Shield

Size:
12"
16"
20"
TG-REF:E-1308



Gili Wire Saw



Size:
40.5cm
TG-REF:E-1309

**Gili Saw Handles
Locking Loop**

Orthopedic Cutter

TGIND
Instruments

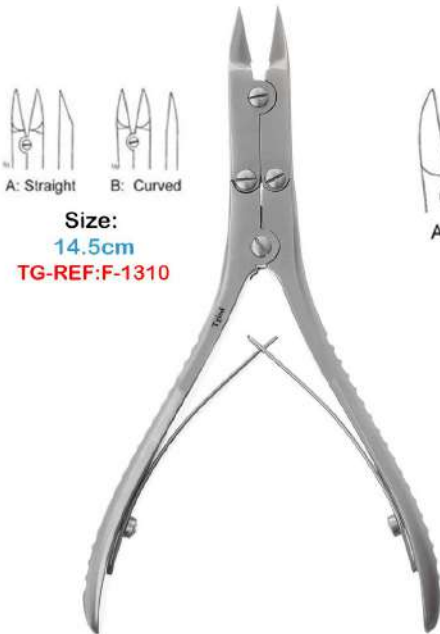

**Kleinert-Kutz / Bohler
Bone Cutting Forceps**

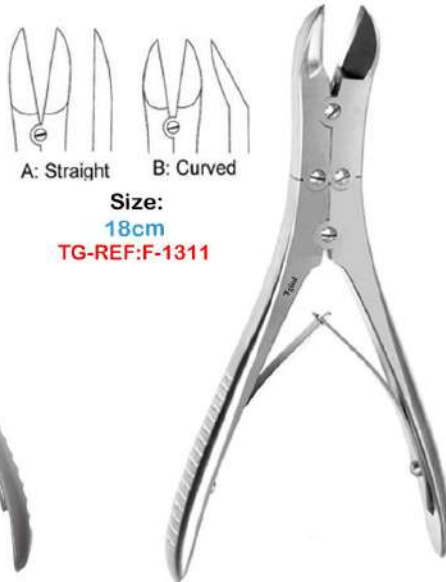

**Ruskin Liston Bone Cutting
Forceps**



**Stile Liston Bone Cutting
Forceps**



**Stile Liston Bone Cutting
Forceps**



**Cleveland Bone Cutting
Forceps**



**Me Indoe Cutting Forceps
Delicate Blades**



TAHIR GROUP OF INDUSTRIES



+92-300-6669737



TAHIR GROUP OF INDUSTRIES



TGIND.COM



TAHIR GROUP OF INDUSTRIES



info@tgind.com

195-F

Orthopedic Cutter

TGIND
Instruments

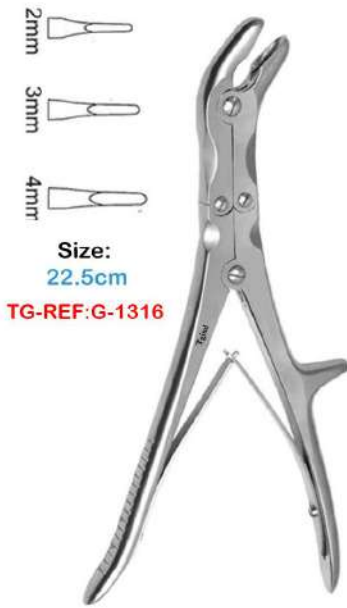

Size:
22.5cm
TG-REF:G-1316

**Stile Bone Rongeur
Forceps**



Size:
22cm
TG-REF:G-1317

**Echlin Duckbill Bone Rongeur
Forceps**



Size:
18cm
TG-REF:G-1318

**Ruskin Bone Cutting
Forceps**



Size:
24cm
TG-REF:G-1319

Ruskin Bone Rongeur



Size:
24cm
TG-REF:G-1320

Leksell Stile Bone Rongeur



Size:
24cm
TG-REF:G-1321

Reksell Bone Rongeur



TAHIR GROUP OF INDUSTRIES



+92-300-6669737



TAHIR GROUP OF INDUSTRIES



TGIND.COM



TAHIR GROUP OF INDUSTRIES



info@tgind.com

195-G

Orthopedic Cutter

TGIND
Instruments



Size:
23.5cm
TG-REF:H-1322

**Semb Bone Rongeur
Forceps**



8mm
Size:
23.5cm
TG-REF:H-1323

**Stile Ruskin Bone Rongeur
Forceps**

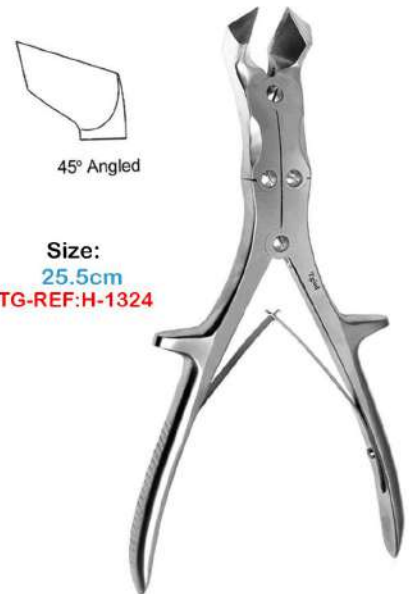

45° Angled
Size:
25.5cm
TG-REF:H-1324

**Stile Horsley Liston Key Bone
Cutting Forceps**

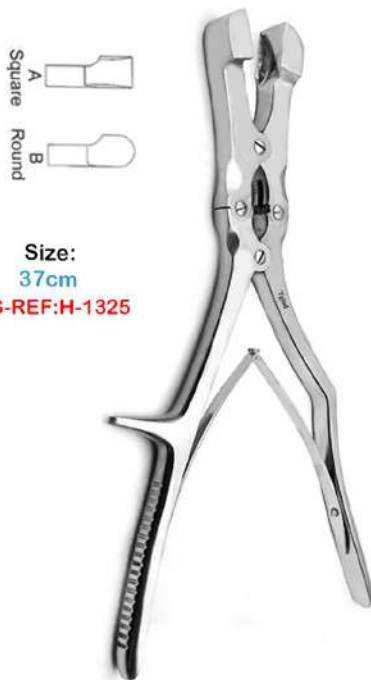

Size:
37cm
TG-REF:H-1325

Sauerbruch Bone Rongeur



Size:
22.5cm
TG-REF:H-1326

Stile Luer Bone Rongeur

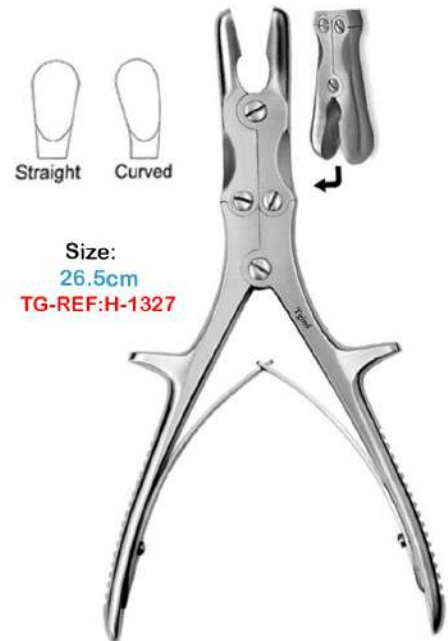

Size:
26.5cm
TG-REF:H-1327

Stile Luer Bone Rongeur

Orthopedic Wire Cutting Plier



Angled
Size:
15cm Cut up to 1.3mm
18cm Cut up to 1.6mm
23cm Cut up to 2.5mm
TG-REF:J-1328

**Wire Cutting Plier
TC Gold**



Size:
15cm Cut up to 1.3mm
TG-REF:J-1329
23.5cm

**Front End Wire Cutting
Plier TC Gold**



Size:
18cm Cut up to 1.5mm
TG-REF:J-1330

**Cannulated Plier Cutter
TC Gold**



Size:
23cm Cut up to 3.0mm
TG-REF:J-1331

**Plate Pin Cutting Plier
TC Gold**



Size:
23cm Cut up to 2.5mm
TG-REF:J-1332

**Pin Wire Cutting Plier
TC Gold**



Size:
30cm Cut up to 3mm
47cm Cut up to 5mm
56cm Cut up to 6mm
60cm Cut up to 7mm
TG-REF:J-1333

**Heavy Duty Pin Cutting Plier
TC Gold**



TG-REF:K-1334

Handle With Chuck T-Shaped



11-257-01 Chuck borhardt shaft
max opening 6.35

11-257-02
Wrench

TG-REF:K-1335

Martin Hand Drill With Chuck & Wrench



Twist Drill 70 X 3.2mm X 2 drills

Twist Drill 90 X 3.2mm X 1 drill

TG-REF:K-1336

Moore Hand Drill With Twist Drills



TG-REF:K-1337

Hudson Braces Hand Drill



TG 11-01-0364 Gerster-Lowman Bone Holding Clamp



Standard Clamp

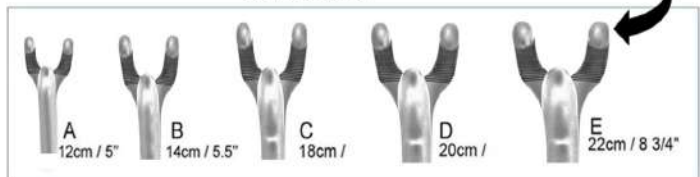

A
12cm / 5"

B
14cm / 5.5"

C
18cm /

D
20cm /

E
22cm / 8 3/4"

TG-REF:K-1338

Gerster-Lowman Bone Holding Clamp



TAHIR GROUP OF INDUSTRIES



+92-300-6669737



TAHIR GROUP OF INDUSTRIES



TGIND.COM



TAHIR GROUP OF INDUSTRIES



info@tgind.com

General Surgery Instruments Set



Description

mixer gall bladder x1
 pean curved x1
 Richardson Retractor x2
 deaver retractor x1
 crilewood forceps x1
 artery forceps curved x1
 mosquito cvd x1
 denis forceps x1
 Adson Kocher x1
 Adson Dressing Forceps x1
 dressing forceps x1
 mayo scissor curved x1
 mayo scissor straight x1
 kocher forceps straight x1
 Scalpel Handle #3 #4 x2
 mayo safety clip x1
 yunker tube x1
 artery straight x1
 Goelet Retractor x1
 us army retractor x1
 small langenback x1
 mayo scissors x1
 pean straight x1
 mixer o shaughnessy x1
 forest spongs forecps x1
 backhaus Clamp large x1
 poole suction x1
 kelly retractor x1
 balfour retractor x1
 lung forceps x1
 Allis Tissue Forceps x1
 Babcock Tissue Forceps x1
 Mayo Hegar needle holder x1
 metzenbaum scissors straight x1
 metzenbaum scissors curved x1
 kidney Tray x1

TG-REF:1285

Minor Surgery Instruments Set



Description

Iris Scissors Sraight
 Adson Tweezers
 Dressing Scissors
 Probe Straight
 Probe Curved
 Tongue Tie Director Plain
 Spencer Stitch Scissors
 Scalpel Handle Blade #3
 Scalpel Handle Blade #4
 Scalpel Handle #5
 Scaler Tray
 Mathieu Needle Holder
 Pean Forceps Curved
 Thumb Dressing Forceps
 Semken Kocher Tweezers
 London College Tweezers

TG-REF:1286



Herniorrhaphy Surgery Instruments Set

Description



- Kidney Dish Medium 8 "
- Kidney Dish Big 12 "
- Gallipot 10ozs
- Gallipot 06ozs
- Gallipot 04ozs
- Sponge Forceps – Rampley 25cm, 10"
- Scalpel Handle Standard No.3
- Dressing Forceps – Standard serrated 13cm,5" =
- Dressing Forceps – McIndoe 15cm, 6"
- 1Dressing Forceps – Lister/Sinus 18cm, 7"
- Tissue Forceps – Gillies 15cm, 6"
- Tissue Forceps – Tooth 13cm, 5"
- Dissecting Scissors – Metzenbaum Curved 17.5cm,7"
- Dissecting Scissors – Mayo Straight 15cm, 6"
- Dissecting Scissors – Mayo Curved 15cm, 6"
- Artery Forceps – Crile Straight 14cm, 5 1/2"
- Artery Forceps – Crile Curved 14cm, 5 1/2"
- Adson Haemostatic Forceps Straight Size: 185 mm
- Adson Haemostatic Forceps Cuvred Size: 185 mm
- Tissue Seizing Forceps – Allis 19cm, 7" 2
- Intestinal Tissue Forceps – Babcock 16cm, 6 1/4"
- Needle Holder – Crile Wood 15cm, 6"
- Needle Holder – Mayo Hegar 18cm, 7"
- Needle Holder – Mayo-Hegar 20cm 1
- Retractors – Langenback Small (Blade 22mmx6mm)
- Retractors – Langenback Medium (Blade 40mmx11mm)
- uction Tubes – Yankauer 27cm, 11"
- Towel Forceps – Schaedal 9cm, 3 1/2"
- Towel Forceps – Lane 20cm, 8"
- Mc Donald Dissector Size: 19cm
- Denis Browne Intestinal Dissecting Forceps Size: 190mm

TG-REF:1287

Hernia Surgery Instruments Set

Description



- 1Sponge Holding Forceps
- 1 Scalpel Handle No.4 & 3
- 1 Toothed Dissecting Forceps 7"
- 1 Plain Dissecting Forceps 7"
- 4 mayo hegar needle holder
- 3 Backhaus Towel Forceps 5"
- 2 Artery Forceps Str. 8"
- 2 Artery Forceps Cvd. 8"
- 2 Allis Tissue Forceps 7"
- 1 Hernia Ring Forceps
- 1 Gemini Ligature Forceps
- 4 Dandy Artery Forceps
- 1 Mayo Hegar Needle Holder 8"
- 1 Metzenbaum Scissors Cvd. 8"
- 1 Farabeuf Retractor set of 2
- 1 Mathieu Retractor set of 2
- 1 Weitlaner Retractor
- 1 kidney tray
- 1 Instruments Box S.S

TG-REF:1288

Spay Neuter Surgery Kit



Description

- 1 x Adson Brown Tissue Fcp, 4 3/4"
- 1 x Allis Tissue Fcp, 4x5 Teeth, 6"
- 4 x Backhaus Towel Clamp, 3 1/2"
- 2 x Halsted Mosquito Fcp, Cvd, 5"
- 2 x Kelly Fcp, Cvd, 5 1/2"
- 1 x Mayo Dissecting Sciss, Str, 6 3/4"
- 1 x Metzenbaum Sciss, Cvd, 7"
- 1 x Mayo Hegar Needle Holder, Serr, 5 1/2"
- 1 x Sponge Forceps STR, 6 1/4"
- 1 x Scalpel Handle, #3
- 1 x Snook Hook
- 1 x Tissue Fcps, 1x2 Teeth, 5 1/2"
- 1 x Box size 20 x 10 x 4 cm

TG-REF:1289

Cat Bitch Ovaries Removal Kit



Description

- X2 MOSQUITO FORCEP CURVED 12CM |
- X4 BACKHAUS FORCEPS 9CM |
- X2 PEAN FORCEPS CURVED 14CM |
- X1 ADSON TISSUE TWEEZER 12CM |
- X1 ADSON BROWN TWEEZER 12CM |
- X2 PEAN FORCEPS STRAIGHT 14CM |
- X1 IRIS SCISSOR STRAIGHT TC 11.5CM |
- X1 MAYO HEGAR NEEDLE HOLDER TC |
- X1 MAYO SCISSOR STRAIGHT 14CM |
- X1 MAYO SCISSOR CURVED 14CM |
- X1 SPAY HOOK | X1 DRESSING TWEEZERS

TG-REF:1290

Abdominal Surgery Kit

Description



- X1 Kidney Tray 8"
- X1 Kelly scissors curved 16cm
- set of 7 Hohmann retractor
- X1 Gallipot
- X1 Sponge Holding Forceps 9.5"
- X1 Towel Clips 5"
- X1 B.P Handle No.4
- X1 Needle Holder 8"
- X1 Toothed Dissecting Forceps 8"
- X1 Plain Dissecting Forceps 8"
- X1 Mayo Scissors Str. 8"
- X1 Crile Artery Forceps Cvd. 6"
- X1 Kocher Forceps Str. 6"
- X1 Stitch Scissors 4.5"
- X1 instruments box ss

TG-REF:1291

Basic Hysterectomy Surgical Instruments



TG-REF:1292

Major Surgery Set 103 Piece



Description

- 6 Sponge Forceps Straight Serrated 9.50"
- 4 Backhaus Towel Clamp 5.25"
- 1 Knife Handle # 3
- 1 Knife Handle # 4
- 1 Knife Handle # 7
- 1 Mayo Scissors Straight 6.75"
- 1 Mayo Scissors Curved 6.75"
- 1 Metzenbaum Scissors Curved 7.00"
- 1 Operating Scissors Straight Sharp/Blunt 5.50"
- 1 Suture Scissors
- 2 Dressing Forceps 5.50"
- 1 Dressing Forceps 8"
- 2 Tissue Forceps 1x2 Teeth 5.50"
- 1 Tissue Forceps 1x2 Teeth 8.00"
- 6 Allis Tissue Forceps 5x6 Teeth 6.26"
- 2 Babcock Tissue Forceps 6.25"
- 12 Halsted Mosquito Forceps Straight 5.00"
- 12 Halsted Mosquito Forceps Curved 5.00"
- 6 Pcs Crile Forceps Straight 6.25"
- 6 Crile Forceps Curved 6.25"
- 10 Rochester-Pean Forceps Curved 6.25"
- 6 Rochester-Ochsner Forceps Straight 6.25"
- 2 Kelly Retractor Small
- 2 Kelly Retractor Medium
- 2 Kelly Retractor Large
- 2 Deaver Retractor 2"
- 2 Volkman Retractor 4 Prong Blunt 9"
- 2 Volkman Retractor 6 Prong Blunt 9"
- 2 Cushing Vein Retractor
- 1 U.S Army Retractor
- 1 Balfour Retractor 7" Spread
- 1 Probe With Eye 5.50"
- 1 Pool Suction Tube Straight
- 2 Mayo Hegar Needle Holder 6"
- 2 Mayo Hegar Needle Holder 7"
- 1 Kidney Tray 10"
- 1 Gelipot 4"
- 1 Aluminium Instruments Container with silicone pad

TG-REF:1293

General Surgery Veterinary Surgical Instruments



Description

- Set Of 7 Hohmann Retractors
- Set Of 2 Fomon Retractors
- Goldman Fox Scissors TC 13cm
- Joseph Skin Prong Hook
- Joseph Skin 2 Prong Hook
- Molt Gag Retractor
- Castroviejo TC Straight 18cm
- Debakay Forceps 15cm
- 2Pcs Farabeuf Retractors
- 3Pcs Microsurgery Tweezers
- Richardson Retractor
- Langenbeck Retractor 44mm
- Langenbeck Retractor 55mm
- Middeldorf Retractor
- Reverse Langenbeck Retractor
- Bowdler Retractor
- Set Of 2 Senn Muller Retractors Sharp/Blunt
- Backhaus Forceps 13cm
- Mixter Forceps 18cm
- Kelly Forceps Straight 18cm
- Pean Forceps Curved 18cm
- Rotatable Scalpel Handle #3
- Sternal Needle Holder 14cm
- Adson Kocher Tweezers
- Allis Tissue Forceps 15.5cm
- Semken Tweezers Toothed 15cm
- Kelly Scissors Curved 16cm
- Goldman Fox Scissors Curved
- Instruments Box
- Kidney Tray 8"
- Bowl Cup

TG-REF:1294

Breast Augmentation Set

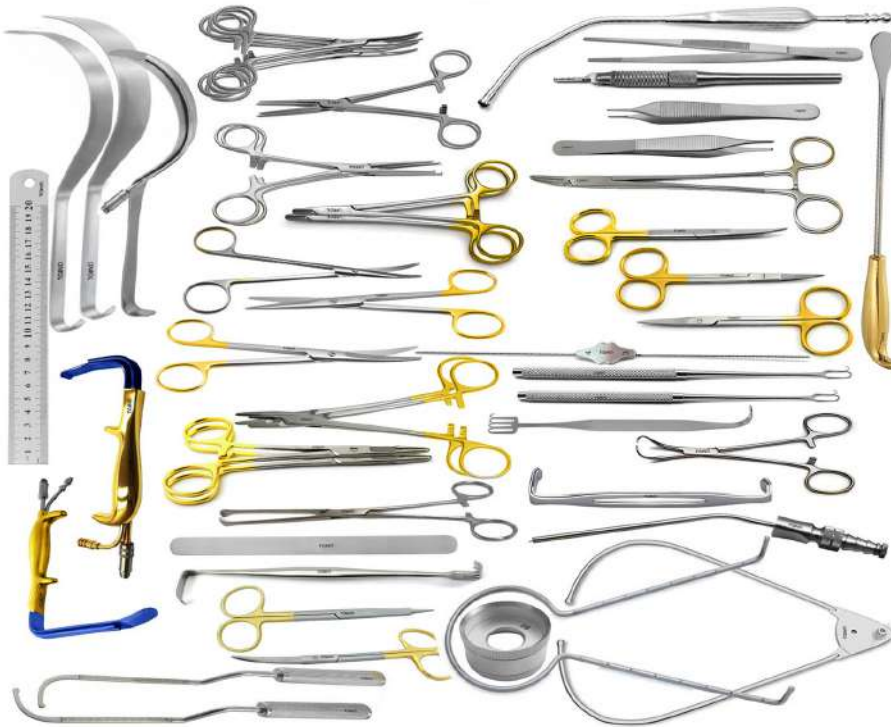

Description

- | | | |
|----|------------------------------|----------------------|
| 1 | Mayo Dissecting Scissors | Curved 6-3/4" |
| 2 | Mosquito Forceps | Straight 3.5" |
| 3 | Mosquito Forceps | Straight 5" |
| 4 | Kocher Forceps | Straight 1X2 5-1/2" |
| 5 | Tissue Forceps Toothed | 1X2 4-1/2" |
| 6 | Webster Needle Holder Smooth | Jaw 5-1/4" |
| 7 | Baumgartner Needle Holder | Serrated 5-1/2" |
| 8 | Olsen Hegar Needle holder | 5-1/2" |
| 9 | Heaney Needle holder | 8-3/4" |
| 10 | Goldman-Fox Scissors | 5" Curved |
| 11 | Allis Tiss Forceps | 4X5 6" |
| 12 | Iris Scissors Straight | 4.5" |
| 13 | Iris Scissors Curved | 4.5" |
| 14 | Joseph Hook 2/Pr Sh | 6" 7mm |
| 15 | Joseph Hook 2/Pr Sh | 6" 5Mm |
| 16 | Backhaus Towel Clamp | 3-1/2" |
| 17 | Frazier Suction Tube | 8 Fr |
| 18 | Adson Tissue Forceps | 1X2 4-3/4" |
| 19 | McKissock Breast Marker | 45mm Keyhole pattern |
| 20 | Deaver Fiber Optic Retractor | 20cm |
| 21 | Adson Dressing Forceps | 4-3/4" |
| 22 | Debaquey Forceps | 7-3/4" |
| 23 | Us Army Retractor | 21cm |
| 24 | Deaver Retractor | 2.5X12" |
| 25 | Ribbon Retractor | 2x13" |
| 26 | Senn Muller Retractor | Sharp 6" |
| 27 | Steven Scissors | Straight 4-1/2" Bb |
| 28 | Steven Scissors | Curved 4-1/2" Bb |
| 29 | Bowman Lach Probe | Sz -3/4" Chrome |
| 30 | Schmidt Tonsil Forceps | 7-1/2" |
| 31 | Metzenbaum Scissors | Straight 7" |
| 32 | Metzenbaum Scissors | Curved 7" |
| 33 | Adson Dressing Tweezer | 12cm |
| 34 | Breast dissector | Left & right 36cm |
| 35 | Fiber Optic Retractor, | Smooth blade 17cm |
| 36 | Fiber Optic Retractor, | with teeth 17cm |
| 37 | Yankaur Suction Tube | 21cm |
| 38 | Freeman Areola Marker, | 38mm |
| 39 | Spatula Breast Dissector | 33cm |
| 40 | Freeman Retractor, | 4 prong |

Basic Thoracotomy Instruments Box Set

TG-REF:1295



TG-REF:1296

Child Laparotomy Extras Set



Description

Lahey Diss and Ligature Fcps Cvd Longitudinal Serr S/S 195mm 7 3/4"
 Denis Browne Pylorus Stretching Fcps S/S 190mm 5 1/2"
 Baby-Kocher Intestinal Calmps For Children Very Elastic Blades Str S/S 130mm
 Baby-Kocher Intestinal Clamps for Children Very Elastic Blades Cvd S/S 130mm
 Payr Intestinal Clamps for Children Light Pattern Length of Jaws 66mm, S/S 180mm
 Naughton Morgan Needle Holders S/S 190mm 7 1/2"
 Kocher Retractor 25 x 60mm S/S 230mm
 Sterile Container box
 Marking Clamps
 Scalpel Blade Handle #3/#4
 Mayo Scissors Curved
 us arm retractor
 pool suction
 balfour retrcator
 dressing tweezers 16cm
 backhaus clamp 13cm
 adson tweezers 12cm

TG-REF:1297

Appendectomy Surgery Kit



Description

INSTRUMENTS BOX STAINLESS STEEL 42X18X9cm / 16 1/2x7x3 1/2"
 GROSS-MAIER DRESSING AND COTTON SWAB FORCEPS 25.0cm / 10", STR
 STANDARD SCALPEL HANDLE NO. 4, SOLID
 BACKHAUS TOWEL FORCEPS 15.0cm / 6"
 HALSTEAD-MOSQUITO ARTERY TISSUE FORCEPS 12.5cm / 5", 1 x 2 TEETH, STRAIGHT
 HALSTEAD-MOSQUITO ARTERY FORCEPS 12.5cm / 5", CURVED
 CHAPUT HOLDING FORCEPS 2x3 TEETH, 13 cm / 5"
 KOCHER (OCHSNER) ARTERY FORCEPS 16.0cm / 6 1/4", 1 x 2 TEETH, STRAIGHT
 BENGOLEA FORCEPS STRAIGHT SERRATED 20 CM
 TISSUE FORCEPS 20.0cm / 8", 1 x 2 TEETH
 STANDARD DRESSING FORCEPS 16.0cm / 6 1/4"
 FARABEUF RETRACTOR 15.0cm / 6", SET OF 2
 FARABEUF RETRACTOR 12.0cm / 4 3/4", SET OF 2
 BALFOUR ABDOMINAL RETRACTOR WITH CENTRAL BLADE 45 x 80mm
 MAYO OPERATING SCISSORS 17.0cm / 6 3/4", STRAIGHT
 MAYO OPERATING SCISSORS 17.0cm / 6 3/4", CURVED
 TOENNIS-ADSON DISSECTING SCISSORS 17.5cm / 7"
 REVERDIN NEEDLES 19.5cm / 7 3/4", SLIGHTLY CURVED
 REVERDIN NEEDLES 19.5cm / 7 3/4", CURVED
 MAYO-HEGAR NEEDLE HOLDERS 16.0cm / 6 1/4"
 BABCOCK TISSUE AND ORGAN HOLDING FORCEPS 18.0cm / 7"
 JUDD-ALLIS TISSUE AND ORGAN HOLDING FORCEPS 15.0cm / 6"
 FARREL COTTON APPLIC. THREADED, 16 cm / 6 1/4"
 LOTION BOWLS MATERIAL: STAINLESS STEEL 80 MM = 225 cc
 YANKAUER SUCTION TUBE 27.0cm / 11"D16-026 1
 MAYO-ROBSON INTESTINAL CLAMP FORCEPS 21.0cm / 8 1/4", STR
 MAYO-ROBSON INTESTINAL CLAMP FORCEPS 21.0cm / 8 1/4", CVD

TG-REF:1298

Craniotomy Surgery Instruments Set

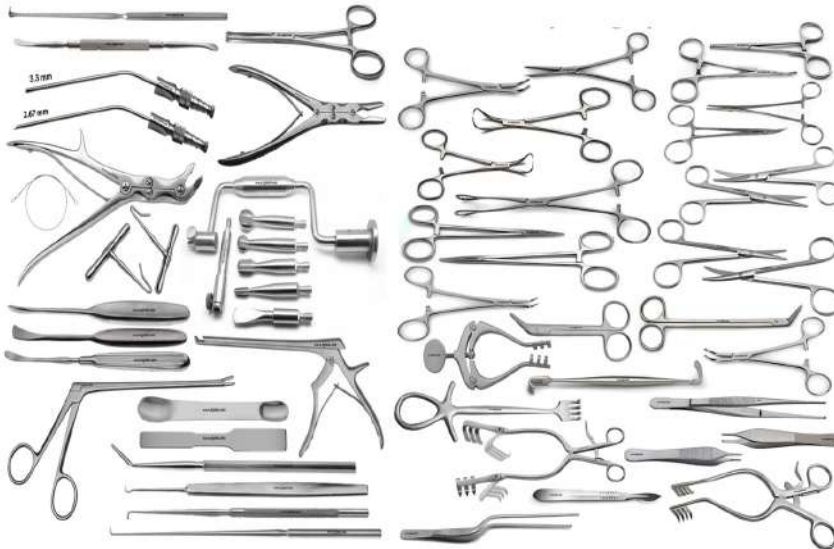

Description

- 1 Knife handle No 3
- 2 Mayo Dissecting scissors 5 1/2" (14 cm), str; Carb-N-Sert Blades
- 3 Mayo Dissecting scissors 5 1/2" (14 cm), Cvd, Carb-N-Sert Blades
- 4 Metzenbaum Scissors 7" (17.8 cm), Cvd, Carb-N-Sert Blades
- 5 Potts-Smith Scissors 7 1/2" (19.1 cm), 25 angle 1 Pcs
- 6 Adson scissors 6 1/4" (15.9 cm), str. Sharp point
- 7 Metzenbaum Scissors 7" (17.8 cm), str; Carb-N-Sert Blades
- 8 Adson Dressing Forceps 4 3/4" (12.1 cm) , Serr 1 Pcs
- 9 Adson Dressing Forceps 4 3/4" (12.1 cm) , 1x2 T
- 10 Cushing Tissue Forceps 7" (17.8 cm), 1x2 teeth 1 Pcs
- 11 Adson Bayonet Forceps 8 1/4" (21 cm), serr: 1 Pcs
- 12 Halsted Mosquito Forceps 5" (12.7 cm) str. Delicate
- 13 Halsted Mosquito Forceps 5" (12.7 cm) Cvd, Delicate
- 14 Dandy Scalp Hemostat 5 1/2" (14 cm) 12 Pcs
- 15 Rochester-Ochsner Forceps 6 1/4" (15.9 cm) , str
- 16 Bockhaus Towel clamp 3 1/2" (8.9 cm) 8 Pcs
- 17 Bockhaus Towel clamp 5 1/4" (13.3 cm) 8 Pcs
- 18 Forster Sponge Forceps 9 1/2" (24.1 cm), Str, Serr.
- 19 Crile-wood Needle holder 6" (15.2 cm), Carb-N-Sert Jaw
- 20 Crile-wood Needle holder 7" (17.8 cm), Carb-N-Sert Jaw
- 21 wire cutting Scissors 4 3/4" (12.1 cm) angular 1 Pcs
- 22 Jansen-wagner Retractor 5" (12.7") , blunt 1 Pcs
- 23 Serrm Retractor 6 3/8" (16.2 cm), Double end, Sharp
- 24 Murphy Retractor 7 1/2" (19.1 cm) 4 prong, sharp
- 25 Beckman Retractor 12 1/2" (31.8 cm) , sharp
- 26 Adson Retractor 7 1/2" (19.1 cm), Sharp
- 27 Allis Tissue Forceps 6" (15.2 cm) 2 Pcs
- 28 Freer Elevator 7" (17.8 cm) double end 1 Pcs
- 29 Frazier Ferguson Suction Tube, 7 Fr (2.3 mm)
- 30 Frazier Ferguson Suction Tube, 8 Fr (3 mm)
- 31 Olivecrona Rongeur 8.5" (22cm) 1 Pcs
- 32 Stille-Luer Rongeur 9" (22.9 cm), angled
- 33 Cushing perforator Drill Set
- 34 Gigli Saw 20" (50.8 cm) 2 Pcs
- 35 Bailey Gigli saw Guide 12" (30.5 cm)
- 36 Luer Rongeur 7" (17.8 cm), str
- 37 Milltex-Kerrison Cervical Rongeur 7" (17.8 cm), 3mm Bite
- 40 degree Forward
- 38 Scoville Brain Spatula 8" (20.3 cm)
- 39 Cushing Spatula Spoon 6 3/4" (17.1 cm)
- 40 Frazier Dura Separator 6 1/2" (16.5 cm)
- 41 Frazier Dura Hook 5" (12.7 cm), sharp
- 42 Dandy Nerve Hook 9" (22.9 cm), str
- 43 Love Nerve Retractor 8 1/2" (21.6 cm), Str angled 45 degree
- 44 Hoon Dura Separator 6" / 45d
- 45 Cushing Little Joker Periosteal Elevator 7 1/2" (19.1 cm)
- 46 Langenbeck Periosteal Elevator 7 1/2" (19.1 cm) 1 Pcs
- 47 Adson Periosteal Elevator 6 1/2" (16.5 cm), blunt
- 48 Kelly Forceps STR 14cm
- 49 Kelly Forceps Cvd 14cm
- 50 Halsted Kocher Forceps Str 12.5cm

TG-REF:1301

Mastoid Tympanoplasty Set



Description

- 1 Wild Aural Forceps Large 13cm
- 2 FAGGE Aural Bayonet Forceps 12cm
- 3 ADSON Plain Forceps 11cm
- 4 ADSON Forceps With 1x2 Teeth 11cm
- 5 HARTMAN Aural Forceps 3 1/2", smooth, 4mm jaw
- 6 OSSICLE Holding Forceps 4x5 teeth 11cm
- 7 TILLEY Aural Forceps 14cm Serr angled
- 8 LEMPERT Rongeur Curved 15cm
- 9 PLERSTER Self Retaining Retractor 2x2 Prongs
- 10 WULLSTEIN Self Retaining Retractor 3x3 Prongs
- 11 WULLSTEIN Self Retaining Retractor 4x4 Prongs
- 12 PLESTER JANSEN Retractor Solid Blade Left 5.5" 14mm
- 13 PLESTER JANSEN Retractor Solid Blade Right 5.5" 14mm
- 14 GLEGG Aural Snare 23cm
- 15 JANSEN Chisel 14cm
- 16 JANSEN Osteotome 14cm
- 17 JENKINS Gouge 14cm
- 18 Cone Self Retaining Retractor Blunt 3x4 Prongs
- 19 LEMPERET Mastoid Curette
- 20 FARABEUFF Elevator Curved
- 21 KERRISON Bone Punch 90d up/ 20cm
- 22 HOUSES Graft Press Forceps 14cm / jaw 20mm
- 23 MASTOID Suction Tube 6FR/8FR/10FR
- 24 Baron Suction Tube Set 4FR
- 25 Micro Aural Crocodile Forceps Up 14cm
- 26 Micro Crocodile Cup Forceps Oval cup Straight
- 27 Micro Crocodile Scissors Fine Straight
- 28 Frazier Suction Tube 3.3mm / 2.67mm

TG-REF:1302

Neck Surgery Instruments Set



Description

E-Z Lock Instrument Holder	10" x 2-1/2"	Gillies Skin Hook Large	4mm, 7"
Sterilization Container	23" x 11" x 5"	Blair-Rollet Retractor	4 Prong 5-1/2"
Sterilization Wire Basket	20-1/2" x 10" x 3", 3"	Lorna-Edna Towel Clamp	5-1/4"
TC Metzenbaum Scissor	Curved 5-3/4"	Backhaus Towel Clamp	5-1/4"
TC Metzenbaum Scissor	Straight 5-3/4"	Cushing Nerve Retractor	9"
TC Mayo Scissor	Straight 6-3/4"	Adson Forceps	Serrated 4-3/4"
TC Mayo Scissor	Curved 6-3/4"	Adson Kocher Forceps	1x2 Teeth 4-3/4"
Halsted Mosquito Forceps	Straight, 5"	Debakey Forceps Straight	2mm, 6-1/4"
Halsted Mosquito Forceps	Curved, 5"	Gemini Clamp, Delicate	Angled 6-1/4"
Halsted Kocher Forceps	Straight 12.5cm	US Army Retractor	Double End 8-1/4"
Rochester Pean Forceps	Curved 6-1/4" 6	Richardson Retractor	9-1/2" 1" x 1-1/4"
Rochester Pean Forceps	Straight, 6-1/4"	Volkman Retractor	4 Prongs 8-1/2"
Crile Forceps	Straight 5-1/2"	Senn Retractor Sharp	3 Prong 6-1/4"
Crile Forceps	Curved 5-1/2"	Stevens Tenotomy Scissor	Blunt/Blunt 4-1/2"
Lahey Traction Forceps	6-1/4"	Desmarres Lid Retractor	Blade Blunt 12mm
Mixer Forceps	Right Angle, 5-1/2"	Hurd Tonsil Dissector	Round Tip 8-3/4"
Dressing Forceps	Serrated 6"	Foerster Sponge Forceps	9-1/2"
Tissue Forceps	1x2 Teeth 6"	Bipolar Forceps	1mm, 7"
TC Crile-Wood Needle Holder	Serrated 6"	Foerster Sponge Forceps, Straight, Serrated, Satin Finish, 9-1/2" 3	
TC Mayo-Hegar Needle Holder	Serrated 6"	Bipolar Forceps, 1mm, 7"	
Mosquito Forceps Curved	Serrated, 5" 12		
Weitlaner Retractor	3x4 Blunt 4-1/2"		
Babcock Intestinal Forceps	6-1/4"		
Allis Tissue Forceps	4x5 Teeth 6"		
Weitlaner-Beckman Retractor	3x4 Teeth, Sharp, 6"		
Adson-Brown Forceps	4-3/4"		
Freer Elevator	Sharp/Blunt 7-3/4"		

TG-REF:1303

Face Lift Forehead Surgery Set



Description

- 1-SCALPEL BLADES #15
- 2-SCALPEL HANDLE, #7 fits #9, 10, 11, 12, 12D, 13, 15, 15C blades(2pieces)
- 3-ADSON BROWN DELICATE TISSUE FORCEPS, 12CM, 7X7 TEETH, STRAIGHT
- 4-BABY CRILE WOOD T.C. NEEDLE HOLDER, 15CM "HM" Tungsten Carbide
- 5-BACKHAUS TOWEL CLAMP, 8.5CM
- 6-DEMARTEL SCALP FLAP FORCEPS, 14CM
- 7-FARABEUF BABY RETRACTORS, 12CM, DOUBLE ENDED, SET OF 2
- 8-GILLIES DURA AND SKIN RETRACTOR HOOK, 19CM, SMALL
- 9-GUBISCH T.C. NEEDLE HOLDER, 12.5CM, EXTRA FINE "HM" Tungsten Carbide
- 10-IRIS SUPERCUT SCISSORS, 11.5CM, CURVED
- 11-JOSEPH DELICATE RETRACTOR, 17CM, 2 PRONG, 5MM, SHARP
- 12-LANGENBECK KOCHER RETRACTOR #13, 15MM WIDE X 80MM DEEP, 21CM
- 13-MICRO ADSON FORCEPS, 12CM, 1X2 TEETH 0.8mm tips
- 14-PITANGUY FACELIFT MARKER, 16CM, 5MM WIDE
- 15-SELECT TISSUE FORCEPS, 20CM, 1X2 TEETH extremely fine
- 16-SOLZ "GOLD TIP" SUPERCUT SCISSORS, 20CM, CURVED, SLIGHT BEVEL ON SHANK
- 17-SOLZ RACKET RETRACTOR, 12.5CM, 45X100MM
- 18-SUPERCUT MAYO SCISSORS, 14CM, STRAIGHT
- 19-WALTER RETRACTOR, 19CM, 4 PRONGS,
- 20 kidney tray
- 21 bowl cup
- 22 skin grafting handle
- 23 Barraquer Deweckwer Iris Scissors

TG-REF:1304



TAHIR GROUP OF INDUSTRIES



+92-300-6669737



TAHIR GROUP OF INDUSTRIES



TGIND.COM



TAHIR GROUP OF INDUSTRIES



info@tgind.com

Fess Surgery Instruments Set



Description

- 1 Frazier Suction Tubes, Medium Angle, 100 mm Size: 8
- 2 Frazier Suction Tubes, Medium Angle, 100 mm Size: 10
- 3 Frazier Suction Tubes, Medium Angle, 100 mm Size: 12
- 4 Curved Suction Tube 3mm
- 5 Curved Suction Tube 4mm
- 6 Kerrison rongeur punch 40d up Cutting
- 7 Kerrison rongeur punch 40d Down Cutting
- 8 Scalpel Handle #7
- 9 Sickle Knife #7
- 10 Vienna Nasal Speculum (Large)
- 11 Antrum Ball Probe, Double-Ended
- 12 Ostrum Backbiter Antrum Punch Downward 13cm
- 13 Freer Elevator Double-Ended
- 14 Cottle Elevator Double-Ended
- 15 Antrum Curette Single-Ended
- 16 Metzenbaum Scissors, Curved, 15 cm
- 17 Mayo Scissors, Curved TC 14cm
- 18 Crile Forceps Straight TC 16cm
- 19 Nasal Concha Scissors, Straight 13cm
- 20 Weil-Blakesley Nasal Forceps Curved 90 Degree
- 21 Weil-Blakesley Nasal Forceps, Curved Upward 45°
- 22 Weil-Blakesley Nasal Forceps Straight 140mm
- 23 Heuwieser Antrum Forceps 130mm, 90°
- 24 Circular Mushroom Cutting Punch Straight
- 25 Circular Mushroom Cutting Punch Curved
- 26 Giraffe Forceps Upward 70°
- 27 Giraffe Forceps Upward 90°
- 28 Sterilization Mesh Tray Box (48 x 25cm)

Skin Graft Surgical Instruments Set



Description

- Blade, skin graft, Rocket, disposable 5
- Towel Clip, Backhaus 5
- Dissector, Mac Donald 1
- Forceps, Dissecting, Straight, 1/2 Teeth, Serrated, 150mm 2
- Forceps, Dissecting, Straight, Plain, 145mm 2
- Forceps, Sponge Holding, 200-240mm 2
- Handle, blade, skin graft 2
- Hook, Skin, Gilles 1
- Scissors, Metzenbaum, Straight, 140mm 1
- Humby Skin Graft Knife With Box 1
- Instrument Container, s/s, With Cover

(BTL) Bilateral Tubal Ligation Vaginal Kit



TG-REF:1307

Vaginal Hysterectomy Set



Description

- 1 Surgical Knife Handle #3
- 2 Adson Dressing Forceps, 4 3/4"
- 3 Russian Tissue Forceps, 8"
- 4 Thumb Forceps, 5.5", Serr. Tips
- 5 Tissue Forceps, 1 x 2, 5.5"
- 6 Adson Tissue Forceps, 6" Serr. Tip
- 7 Backhaus Towel Clamp, 5"
- 8 Foerster Sponge Forceps, 9.5", Str. Serr
- 9 Allis Forceps, 5 x 6, 7"
- 10 Ochsner Kocher Forceps, 6.25", Str
- 11 Mayo Pean Forceps, 6.25", Cvd
- 12 Lahey Forceps, 7 1/2"
- 13 Crile Forceps, 5 1/2" Cvd
- 14 Operating Scissors, 5 1/2", Str. S/B
- 15 Mayo Scissors, 6.75", Cvd, Insert
- 16 Mayo Scissors, 6.75" Str. Insert
- 17 Metzenbaum Scissors, 7", Cvd, Insert..
- 18 Mayo Hegar Needle Holder, 8"
- 19 Heaney Needle Holder, 8.5", Cvd.
- 20 Crile Wood Needle Holder, 6.25"
- 21 Mayo Hegar Needle Holder, 6" Insert
- 22 Yankauer Suction Tube S.S.
- 23 Auvard Speculum 1 Bs-11-30028
- 24 Army Navy Retractor (Set of 2)
- 25 Braun Tenaculum 9.5"..
- 26 Heaney Simon Vaginal Retractor
- 27 Jackson Retractor, 3" x 1.38".
- 28 Instruments box

TG-REF:1308



Obstetric Surgery Major Kit



Description

- 1 Kidney Tray 8"
- 1 Gallipot
- 1 Sponge Holding Forceps 9.5"
- 2 Towel Clips 5"
- 1 B.P Handle No.4
- 1 Episiotomy Scissors 7.5"
- 1 Needle Holder 8"
- 1 Toothed Dissecting Forceps 8"
- 1 Plain Dissecting Forceps 8"
- 1 Mayo Scissors Str. 8"
- 4 Crile Artery Forceps Cvd. 6"
- 1 Instrument Pin
- 2 Kocher Forceps Str. 6"
- 1 Stitch Scissors 4.5"
- 1 Graves Vaginal Speculum
- 1 instruments box ss

TG-REF:1309

IV CUT Down Instruments Set



Description

- Mosquito Forceps Str
- Mosquito Forceps Str
- Senn Mueller Retractor
- Mathieu Needle Holder
- Langenbeck Retractor
- Iris Scissors Curved
- Dressing Scissors
- Spencer Scissors
- Backhaus Clamp
- Geli Pot
- Scalpel Handle #3
- Scalpel Handle #4
- Kidney Tray

TG-REF:1310

Urology Surgery Set

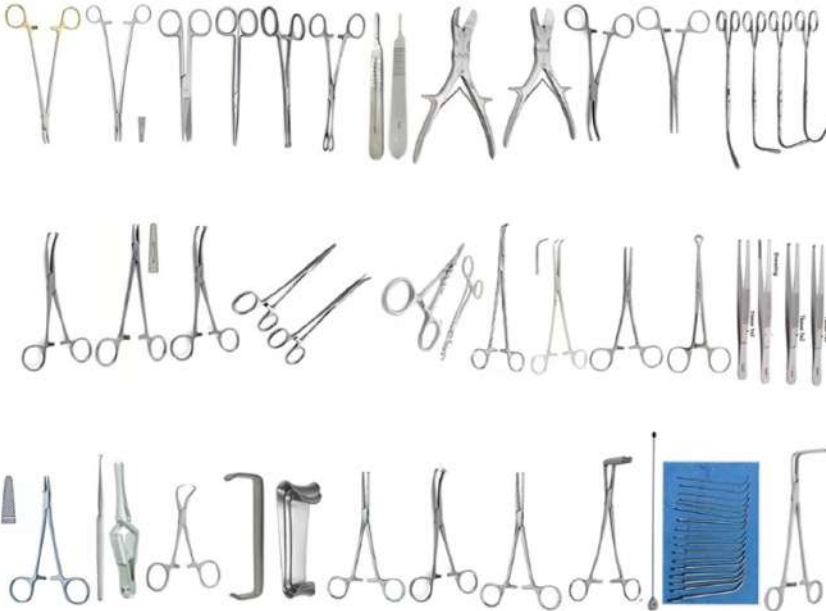

Description

- 1 Randall Fcp 1/4 Crv 9 1/4" 1
- 2 Randall Fcp 1/2 Crv 8 1/2" 1
- 3 Randall Fcp 3/4 Crv 7 3/4" 1
- 4 Randall Fcp Full Crv 7 3/4" 1
- 5 Lees Bronchus Clip 9" 1
- 6 Van Buren Sound Set Of 17 1
- 7 Otis Bougie A Boule 8fr 1
- 8 Otis Bougie A Boule 12fr 1
- 9 Otis Bougie A Boule 16fr 1
- 10 Otis Bougie A Boule 10fr 1
- 11 Wertheim-cullen Ped Clip 8 1/2" 2
- 12 Ballengr Spng Fcps Str Serr 7" 2
- 13 Allis Tiss Fcp Del 5x6 9 1/2" 2
- 14 Allis Tiss Fcp Del 5x6 7 1/2" 2
- 15 Allis Tiss Fcp 5x6 6" 2
- 16 Metz-nelson Sciss Str 9" 2
- 17 Metz-nelson Sciss Str 9" 2
- 18 Op Sciss 5 1/2" Str Sh/bl 2
- 19 Op Sciss 6" Str Sh/bl 2
- 20 Op Sciss 6 1/2" Str Sh/bl 2
- 21 Mayo Hegar Nh Ser Masson 101/2" 2
- 22 Gillies Skin Hook 7" 4mm 1
- 23 Crile Wood Nh Narrow Jaws 6" 1
- 24 Mayo Hegar Nh Serr 6" 1
- 25 Mayo Hegar Nh Serr 7" 1
- 26 Mayo Hegar Nh Serr 8" 1
- 27 Heaney Nh Cvd Serr 8 1/4" Tc 1
- 28 Roch Ochsner Fcp Cvd 1x2 6 1/4" 1
- 29 Roch-osch Fcps Str 1x2 6 1/4" 1
- 30 Roch Ochsner Fcp Cvd 1x2 7 1/4" 1
- 31 Roch Ochsner Fcp Str 1x2 7 1/4" 1
- 32 Roux D/e Retractors Set/3 1
- 33 Baby Farabeuf Rets St/2 4 3/4" 1
- 34 Backhaus Towel Clamp 5 1/4" 4
- 35 Johns Hopkins Bulldog Clip 2 1/2" 2
- 36 Tissue Fcp 1x2 5 1/2" 2
- 37 Dressing Fcp Serr 7" 1
- 38 Tissue Fcp 1x2 7" 1
- 39 Tissue Fcp 1x2 8" 1
- 40 Tissue Fcp 1x2 10" 1
- 41 Tissue Fcp 1x2 12" 1
- 42 Tissue Fcp 3x4 5 1/2" 1
- 43 Tissue Fcp 3x4 6" 1
- 44 Tissue Fcp 4x5 5 1/2" 1
- 45 Tissue Fcp 1x2 5 1/2" 1
- 46 Tissue Fcp 1x2 6" 1
- 47 Babcock Forceps 6 1/4" 1
- 48 Babcock Forceps 8" 1
- 49 Babcock Forceps 9 1/2" 1
- 50 Roch Pean Fcp Str 6 1/4" 1
- 51 Mixer Fcp Rt Ang 7 1/2" 1
- 52 Gemini Clamp Del Ang 8" 1
- 53 Halsted Mosq Fcp Str 5" 1
- 54 Halsted Mosq Fcp Cvd 5" 1
- 55 Crile Fcp Str 5 1/2" 1
- 56 Crile Fcp Cvd Del 5 1/2" 1
- 57 Crile Fcp Str Del 5 1/2" 1
- 58 Roch-pean Fcp Del Cvd 8 1
- 59 Roch-pean Fcp Str 8" 1
- 60 Mixer Fcp Crv 9 1/4" 1
- 61 Roch Pean Fcp Cvd 9" 1
- 62 Stille-list Bone Fcp Str 101/2" 1
- 63 Stille-list Bone Fcp Cvd 101/2" 1
- 64 Scalpel Handle #4 2
- 65 Scalpel Handle #3 2

TG-REF:1311

Cranioplasty Surgery Set



Description

- 1 FORCEPS, ADSON, 12 cm, serrated jaws
- 2 FORCEPS, ADSON, 12 cm, 1x2 teeth
- 3 SUCTION TUBE, FRAZIER, CH 12, 12.5 cm, angular
- 4 FORCEPS, HEMOSTATIC, H-MOSQUITO, 12.5 cm, curved
- 5 FORCEPS, HEMOSTATIC, DANDY, 14 cm, serrated, sideways curved
- 6 RETRACTOR, HOOK, SKIN, BARSKY, 15 cm, single prong, sharp
- 7 RASPATORY, FARABEU, 150x13mm, light curved, sharp
- 8 RONGEUR, BONE, FRIEDMANN, 14 cm x 2,5 mm, curved, delicate
- 9 FORCEPS, BONE CUT., LISTON, 17 cm, standard, straight
- 10 SCISSORS, VASCULAR, POTTS-SMITH, 19cm, 60deg angled
- 11 RONGEUR, LAMINECTOMY, SPURLING-KERRISON, 20cm, jaws 15mm
- 12 DISSECTOR, DURA, OLIVECRONA, 18 cm, double ended 4 + 5 mm
- 13 DRILL, HAND, CRANIAL, HUDSON, complete set
- 14 (drill, hand, cranial, Hudson) DRILL, CUSHING, 14mm, flat
- 15 (drill, hand, cranial, Hudson) PERFORATOR, McKENSIE, 13mm
- 16 (drill, hand, cranial, Hudson) PERFORATOR, D ERRICO, 16mm
- 17 SAW GIGLI, HANDLE, inpairs
- 18 SAW GIGLI, WIRE, 50 cm
- 19 SAW GIGLI, GUIDE, DeMARTEL, 33 cm
- 20 CANNULA, TEAR DUCT, RANDOLPH, 15mm, Luer-Lock
- 21 LEVER, BONE, LANE, 21 cm
- 22 BASKET, STERILIZING, 240 x 255x 100mm, + lid

TG-REF:1312

Maxillofacial Surgery Instruments Set



Description

Hayton William Forceps Forward traction 25cm
 Bone Reduction Bone Holding Forceps Pointed 15cm
 Rowe Maxillary Disimpaction Forceps Right and Left in Pair 24cm
 TMJ Spreading Forceps
 Rowe Zygomatic Elevator 21.5cm
 Bristow Elevator 9.5"
 WarWick James Elevator Right and left Pair left right
 Pair Periosteal Elevator Fiber Handle Shape 2 Curved 6mm
 Self Retaining Mastoid Retractor 6"
 Channel Retractor Regular 12mm"
 Kilner Retractor c Shape Big
 Double Hook skin retractor
 Chin retractor 16cm , 42x16mm Blade
 Forked Ramus Retractor
 Austin Tissue Retractor Regular
 Soft Tissue Retractor Reverse Lengenbeck
 Right Angle Retractor Small Medium Big each
 Rowe Orbital Floor Retractor Right and Left in pair
 Pair Ryne Mandibular Retractor
 Condyle Retractor Double ended

TG-REF:1313

A.V Fistula & Bladder Surgery Set



Description

1 Multi-Cut Utility Scissors Serrated Black 7-1/2" 2
 Mayo Dissecting Scissors Straight 6-3/4"
 3 Mayo Dissecting Scissors Curved 6-3/4"
 4 Crile Forceps Curved 5-1/2"
 5 Rochester-Ochsner Forceps Straight 1x2 Teeth 6-1/4" 6
 Scalpel Handle #4
 7 TC Mayo-Hegar Needle Holder Serrated Tungsten Carbide 6"
 8 Tissue Forceps 1x2 Teeth 6"
 9 Liston Amputating Knife 8" Blade 13"
 10 Stille-Luer Rongeur Double Action Straight 8-1/2"
 11 Stille-Listan Rongeur Curved Double Action 10-1/2" 12 Bruns
 Bone Curette Oval #0 6-3/4"
 13 Bruns Bone Curette Oval #3 6-3/4" 14 Key Elevator 1" 7-1/2"
 15 Langenbeck Elevator Single End Narrow 7-1/2" 16 Langenbeck
 Elevator Single End Wide 7-1/2"
 17 Wire Loop Handle For Gigli Saw Pack of 2
 18 Putti Bone Raspatory Curved Ends Round and Half-Round
 Tapered 12" 19 Satterlee Bone Saw 12"
 20 Percy Amputation Retractor
 21 Steel Ruler 12"
 22 Sterilizing Tray 20" x 10-1/2" x 3-1/2"
 23 Weinstein Stenlizing Rack 5-1/2"

TG-REF:1314



Gastrointestinal Surgery Set

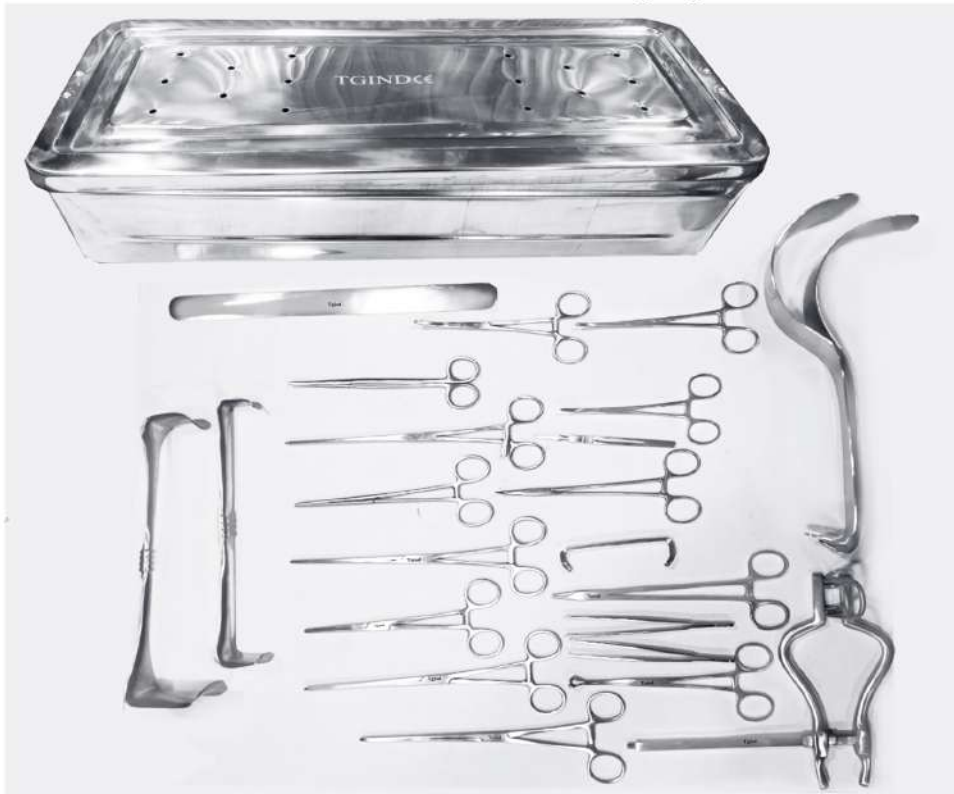

TG-REF:1315

Kidney Transplant Surgery Setup

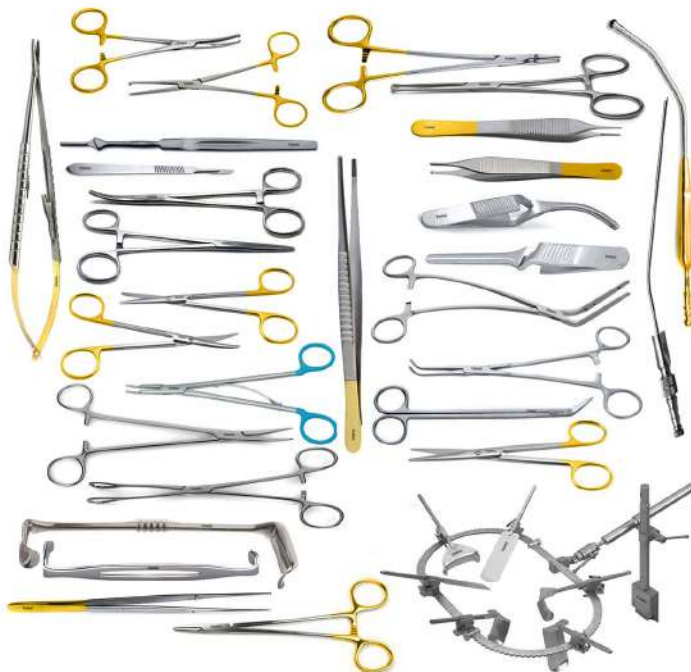

Description

- Bote stainless steel, 50 x 20 x 12 cm, 1 piece
- Hysterometer Valleix with cursor, 33 cm, 1 piece
- Curette Uterine Gourdet, 25 cm x 12 mm, 1 piece
- Curette Uterine Simon, 25 cm x 6 mm, 2 piece
- Curette Uterine Sims, sharp, 25 cm x 6 mm, 1 piece
- Curette Uterine Sims, sharp, 25 cm x 10 mm, 1 piece
- Curette Uterine Wallich, 35 cm x 14 mm, 1 piece
- Suction Curette for curettage with connector, 8 mm, 1 piece
- Suction Curette for curettage, with fitting, 10 mm, 1 piece
- Suction Curette for curettage, with fitting, 14 mm, 1 piece
- Dressing Forceps, "Longuette" right, 24cm, 2 pieces
- Museux pliers, straight, 24 cm, 7 x 5 mm, 1 piece
- Pozzi forceps, straight, 24 cm, 1 piece
- Foerster forceps, serrated, 24 cm, straight, 1 piece
- Candle Hegar, double, stainless steel, 20 cm, set of 8 pieces:
 - n3 / 4 n17/18, 1 piece
- Vaginal Speculum IS04635 Collin, 35 mm, length 110 mm, 1 piece
- Valve vaginal Dean, 90 mm x 45 mm, 1 piece
- Valve vaginal Dean, 120 mm x 45 mm, 1 piece
- Valve Auvard, fixed weight 1100 gr, 1 piece
- Suction Curette for curettage with fitting 6 mm, 1 piece
- Suction Curette for curettage, with fitting, 12 mm, 1 piece

TG-REF:1316

Caesarean Surgical Set



TG-REF:1317

Gynae Delivery Set



TG-REF:1318

Gynaecology Curettage & Abortion Holtex



Description

- Bote stainless steel, 50 x 20 x 12 cm, 1 piece
- Hysterometer Valleix with cursor, 33 cm, 1 piece
- Curette Uterine Gourdet, 25 cm x 12 mm, 1 piece
- Curette Uterine Simon, 25 cm x 6 mm, 2 piece
- Curette Uterine Sims, sharp, 25 cm x 6 mm, 1 piece
- Curette Uterine Sims, sharp, 25 cm x 10 mm, 1 piece
- Curette Uterine Wallich, 35 cm x 14 mm, 1 piece
- Suction Curette for curettage with connector, 8 mm, 1 piece
- Suction Curette for curettage, with fitting, 10 mm, 1 piece
- Suction Curette for curettage, with fitting, 14 mm, 1 piece
- Dressing Forceps, "Longuette" right, 24cm, 2 pieces
- Museux pliers, straight, 24 cm, 7 x 5 mm, 1 piece
- Pozzi forceps, straight, 24 cm, 1 piece
- Foerster forceps, serrated, 24 cm, straight, 1 piece
- Candle Hegar, double, stainless steel, 20 cm, set of 8 pieces:
 - n3 / 4 n17/18, 1 piece
- Vaginal Speculum IS04635 Collin, 35 mm, length 110 mm, 1 piece
- Valve vaginal Dean, 90 mm x 45 mm, 1 piece
- Valve vaginal Dean, 120 mm x 45 mm, 1 piece
- Valve Auvard, fixed weight 1100 gr, 1 piece
- Suction Curette for curettage with fitting 6 mm, 1 piece
- Suction Curette for curettage, with fitting, 12 mm, 1 piece

TG-REF:1319

Gynaecology DNC Set



TG-REF:1320

DNC Gynaecology Dilation Curettage Set W/Pouch



TG-REF:1323

Episiotomy Instruments Set Of 17Pcs



Description

- X1 Kidney Tray 8"
- X1 Gallipot
- X1 Sponge Holding Forceps 9.5"
- X1 Towel Clips 5"
- X1 B.P Handle No.3
- X1 B.P Handle No.4
- X1 Episiotomy Scissors 7.5"
- X1 Needle Holder 8"
- X1 Toothed Dissecting Forceps 8"
- X1 Plain Dissecting Forceps 8"
- X1 Mayo Scissors Str. 8"
- X1 Crile Artery Forceps Cvd. 6"
- X1 Instrument Pin
- X1 Kocher Forceps Str. 6"
- X1 Stitch Scissors 4.5"
- X1 Graves Vaginal Speculum
- X1 instruments box ss

TG-REF:1324

Abdominal Hysterectomy Set Of 173 Pcs



Description

Set 2 Mayo Diss Sciss Str 6 %
 1 Mayo Diss Sciss Cvd 5 1/2"
 2 Mayo Diss Sciss Cvd 6 3/4"
 12 Halsted Mosq Fcp Cvd 5"
 6 Kelly Fcp Str 5 1/2"
 12 Kelly Fcp Cvd 5 1/2"
 12 Roch-pean Fcp Cvd 6 1/4"
 6 Roch-pean Fcp Cvd 7 1/4"
 12 Roch-osch Fcps Str 1x2 6 1/4"
 2 Serrated Dressing Fcps 5 1/2"
 1 Serrated Dressing Fcps 8"
 2 Tissue Fcp 1x2 5 1/2"
 1 Tissue Fcp 1x2 8"
 2 Crile Murray Nh Serr 6" Tcsg
 2 Mayo Hegar Nh 7" Tcsg
 2 Mayo Hegar Nh 8" Tcsg
 1 Metz Lahey Del Cry Sciss 5 3/4
 1 Sut Wire Cut Scis Ser Ang 43/4

4 Babcock Forceps 5.5"
 4 Babcock Forcep 8"
 12 Allis Tiss Fcp 3x4 6"
 4 Allis Tiss Fcp 5x6 7 1/2"
 1 Us Army Retr Set/2 Dle 8 1/4"
 1 Parker De Retr 5/8x5 Set/2
 2 Kelly Retractor 9.5" 2"x2.5"
 2 Richardson W/sklgrp Hndl Med
 1 Richardson-eastman Retr Set/2
 1 Deaver Skl Grip Hdl #0 1" X10"
 1 Deaver Skl Grip Hdl #1 1" X12"
 1 Deaver Skl Grip Hdl #2 1"x 13"
 1 Deaver Skl Gr Hdl #3 1-1/2 X12
 1 Deaver Skl Gr Hdl #4 2 X 12
 1 Deaver Skl Gr Hdl #5 3 X 12
 2 Zalkind Ribbon Retr 1 1/2x13"
 2 Volkman Retr Usa Shrp 6pr 81/2
 2 Volkman Retr Usa Shrp 3pr 81/3
 1 Balfour Abdom Retr Fenstr BI7"
 1 Dir&tongue Tie (probe) 6"

1 Ochsner Tr 20fr F 16fr Cath
 1 Poole Suct Tb Slip On Str 30fr
 1 Metzenbaum Scissors Cvd 7
 12 Backhaus Towel Clamp 5 1/4"
 8 Foerster Sponge Serr Str 91/2"
 2 Deaver #5 3x12 1 Tissue Fcp 1x2 8"
 6 Allis Tiss Fcp 5x6 7 1/2"
 1 Tissue Fcp 1x2 12" 6 Roch-pean Fcp Cvd
 1/4" 6 Roch Ochsner Fcp Str 1x2 7 14
 2Schroeder (braun) Ten Fcp 91/2
 2Schroeder Vulslim Fcp Str 9.5"
 4Heaney Single Tooth Hvy 8 1/4"
 1Mayo Diss Sciss Cvd 9"
 1Kelly-adson Sciss Cvd Sm 6 1/4
 1HYSTEREC CLMP ATRAU STR 9 1/2"
 1HYSTEREC CLMP ATRAU SL CV 91/2
 1HYSTEREC CLMP ATRAU 3/4 CRV
 1Scalpel Handle number 3
 1Scalpel Handle number 4

TG-REF:1325



TAHIR GROUP OF INDUSTRIES



+92-300-6669737



TAHIR GROUP OF INDUSTRIES



TGIND.COM



TAHIR GROUP OF INDUSTRIES



info@tgind.com

Obstetric Surgery Set Of 45 Pcs



Description

- | | | |
|-------------------------------------|--|--|
| 1 Dressing Forceps Serrated 15cm | 1 Scalpel Handle #3 | 1 Kocher Langenback Retractor 35x11mm |
| 1 Dressing Forceps Toothed 15cm | 1 Deaver Skl Grip Hdl #2 1"x 13" | 1 Kocher Langenback Retractor 41x11mm |
| 1 Mayo Scissors Straight TC 14cm | 1 Deaver Skl Gr Hdl #3 1-1/2 X12 | 1 Kocher Langenback Retractor 55x111mm |
| 1 Mayo Scissors Curved TC 14cm | 1 Deaver Skl Gr Hdl #4 2 X 12 | 1 Richardson Retractor 44x38mm |
| 3 Metzenbaum Scissors Straight 18cm | 1 Adson Forceps Serrated 15cm | 1 Richardson Retractor 36x28mm |
| 2 Metzenbaum Scissors Curved 20 | 1 Adson Forceps Toothed 15cm | 1 Balfour Retractor Large Center Blade 10" |
| 1 Backhaus Towel Clip 13cm | 2 US Army Retractor 20cm | 1 Poole Suction Tube 23cm |
| 1 Gemini Ligature Forceps 14cm | 3 Kelly Forceps Straight 20cm | 1 Yankauer Suction Tube 27cm |
| 1 Spong Forceps 9.5" | 1 Halsted Kocher Forceps Straight 20cm | 1 Kidney Tray 10" |
| 1 Pean Forceps Straight 8" | 1 Halsted Kocher Forceps Curved 20cm | 1 Bowl Cup |
| 1 Castriviejo Forceps TC 18cm | 1 Dandy Forceps 20cm | |
| 1 Cord Scissors 4" | 1 Allis Tissue Forceps 20cm | |
| 1 Scalpel Handle #7 | 1 Mixer o'shaughnessy forceps 22cm | |
| 1 Scalpel Handle #4 | 1 Mixer o'shaughnessy forceps 19cm | |
| | 1 Deaver Skl Gr Hdl #5 3 X 12 | |

TG-REF:1326



TAHIR GROUP OF INDUSTRIES



+92-300-6669737



TAHIR GROUP OF INDUSTRIES



TGIND.COM



TAHIR GROUP OF INDUSTRIES



info@tgind.com

Orthopedic Surgery Instruments Set

Description

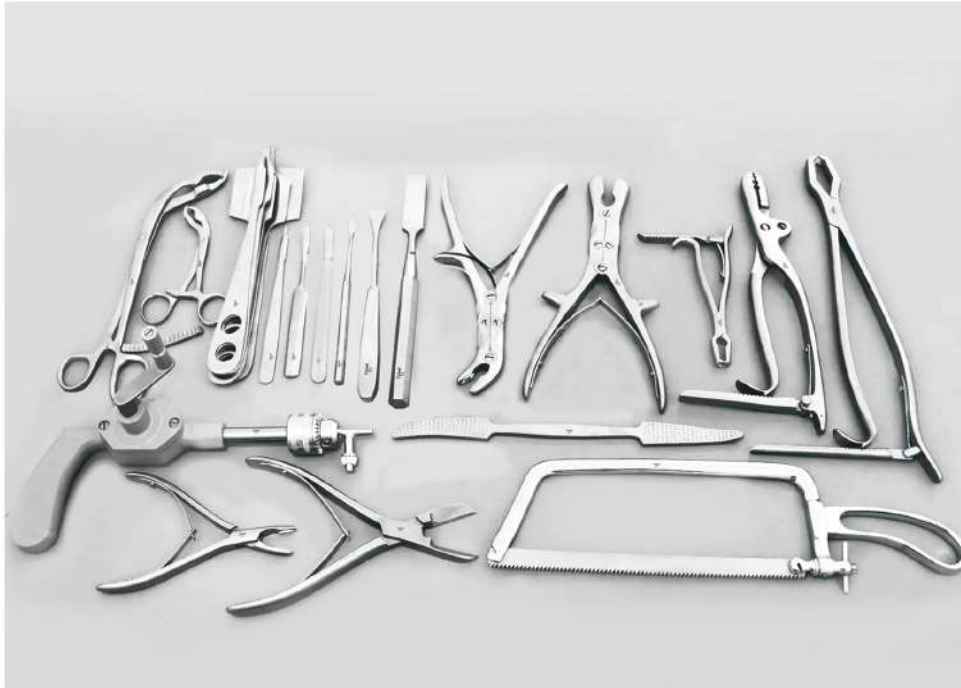

- 7-Assorted Hohmann Bone Levers- 1 Set
- 1 Pc Liston Bone Cutter 7" Str
- 1 Pc Bone Rongure 6" Str
- 1 Pc Stille-luer Bone Ronguer 8.75" Str
- 1 Pc Stille Rongure 9.5" Angled
- 1 Pc Bone Reduction Forceps 5"
- 1 Pc Bone Holding Forceps 16cm
- 1 Pc Verbrugge Bone Holding Forceps 10"
- 1 Pc Farabeuf -Jambotte Bone Holding Forceps 10.5"
- 1 Pc Williger Raspatorie 160mm
- 1 Pc Langenbeck Periosteal Elevator
- 1 Pc Bruns Bone Curette # 0
- 1 Pc Bruns Bone Curette # 1
- 1 Pc Lane Bone Holding Forceps 13" With Ratchet
- 1 Pc Kern Bone Holding Forceps 6" With Ratchet
- 1 Pc Key Periosteal Elevator 7"
- 1 Pc Putti Bone Rasp
- 1 Pc Bone Saw 350mm
- 1 Pc Bone Drill
- 2 Pcs Bone Mallet
- 1 Pc Hibbs Chisel 9.25" 10mm

TG-REF:1327

Casper Cervical Retractors Set



TG-REF:1328

Orthopedic Wiring & Krischner Set



Description

- WIRE, CERCLAGE 1.00 mm x 10m Stainless Steel Coil 1
- WIRE, CERCLAGE, 1.25 mm x 10 m, stainless steel, coil 1
- WIRE, KIRSCHNER, Ø 1.00mm x 15cm, trocard + round end 10
- WIRE, KIRSCHNER, Ø 1.60mm x 15cm, trocard + round end 10
- WIRE, KIRSCHNER, Ø 2.00mm x 15cm, trocard + round end 10
- WIRE, KIRSCHNER, Ø 2.50mm x 15cm, trocard + round end 10
- WIRE, KIRSCHNER, Ø 3.00mm x 15cm, trocard + round end 10
- PLIERS, FLAT NOSE, 16 cm, serrated jaws, heavy pattern
- PLIERS FLAT NOSE 14 CM SERRATED JAW1
- PLIERS ROUND NOSE 14 CM SERRATED JAW 1
- MORIS PLIER WITH TIP 14 CM SERRATED JAW 1
- PALLARL ACTION FLAT NOSE PLIER SERRATED IN JAW 1
- GRIP LIER 18 CM SELF LOCKING 1
- CHUCK, UNIVERSAL (3-jaw) with T-handle + locking device1
- WIRE PASSER DEMEL DIAM 45 MM X28 CM BLUNT1
- WIRE PASSER DIAM 45MM X23CM CURVED LIFT BLUNT 1
- PLIER WIRE CUTTING 26 CM HARD WIRE UP TO DIAM 3.2mm

TG-REF:A-1329

Basic Orthopedic Surgery Instruments Set



Description

- 1 Piece Of Large point Reduction forceps
- 1 Piece Of small point Reduction forceps
- 1 Piece Of Kern Bone Holding Forceps 5.5"
- 1 Piece Of Self Centering Bone Holding
- 1 Piece Of castroviejo caliper 0-20mm
- 1 Piece Of k-wire bender
- 1 Piece Of Meniscus forceps
- 1 Piece Of bending irons
- 1 Piece Of Wire Twister TC
- 1 Piece Of Metzenbaum Scissors TC
- Set Of 7 Pieces Hohman Retractor
- 1 Piece Of Bone Saw
- 1 Piece Of Senn Retractor
- Set Of 3 Piece Of Fraizer Suction Tubes
- Set Of 5 Pieces Periosteal Elevator
- 1 Piece Of Gelpi Retractor 3.5"

TG-REF:A-1330

Orthopedic Large Fragments Kit



Orthopedic Small Fragments Kit Box

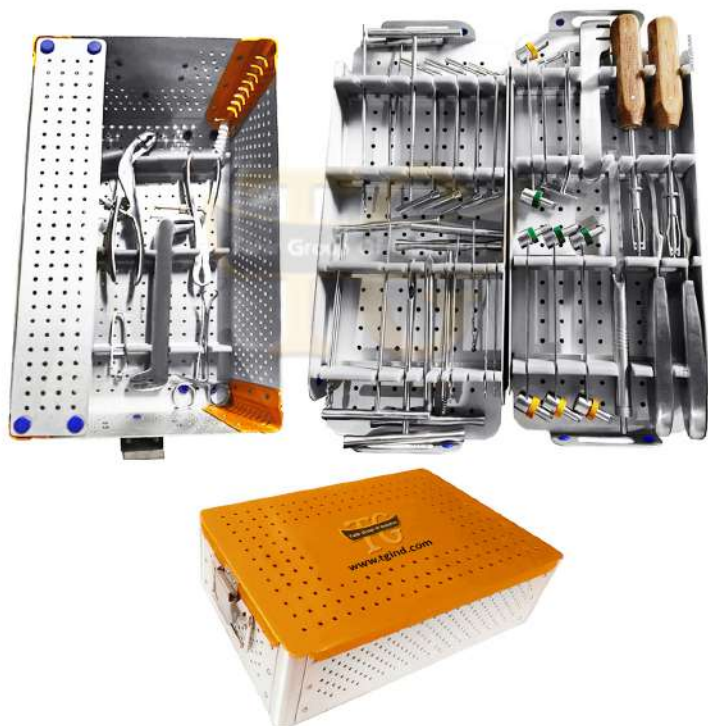

Laminectomy Orthopedic Set



TG-REF:1333

Orthopedic Hip Replacement Kit



TG-REF:1334

Orthopedic Broken Screw Removal Set Box

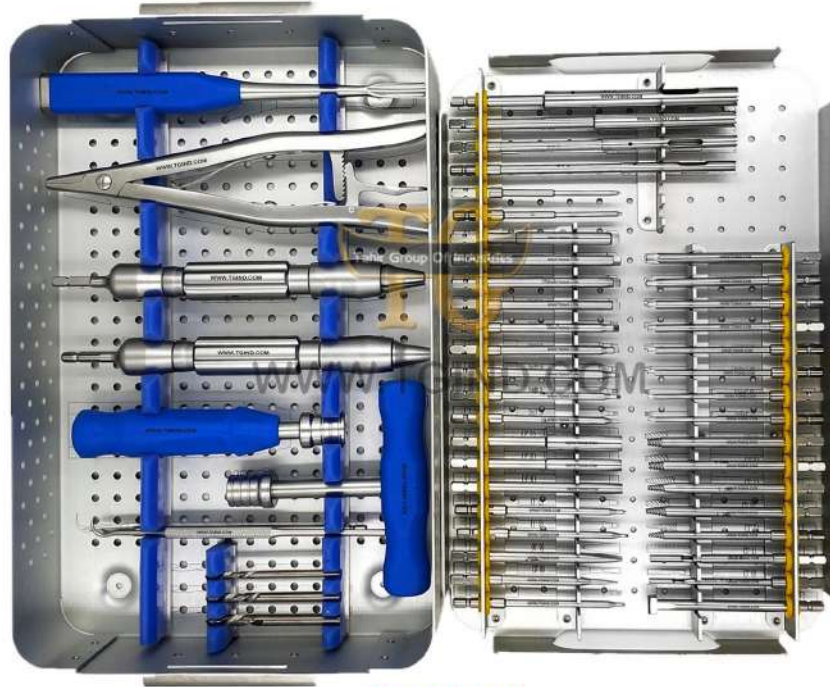

TG-REF:A-1333

Orthopedic Mis Tubular Retractors System Box



TG-REF:B-1333



TAHIR GROUP OF INDUSTRIES



+92-300-6669737



TAHIR GROUP OF INDUSTRIES



TGIND.COM



TAHIR GROUP OF INDUSTRIES



info@tgind.com

Orthopedic DHS & DCS System Box



TG-REF:1337

Lumbar Spine Surgery Set Sterilize Box



TG-REF:1338

Bone Cervical Curettes Orthopedic Set Box



TG-REF:1339

Spinal Pedical Screw System Box Set



TG-REF:1340



Elastic Nail Instruments Orthopedic Set Box

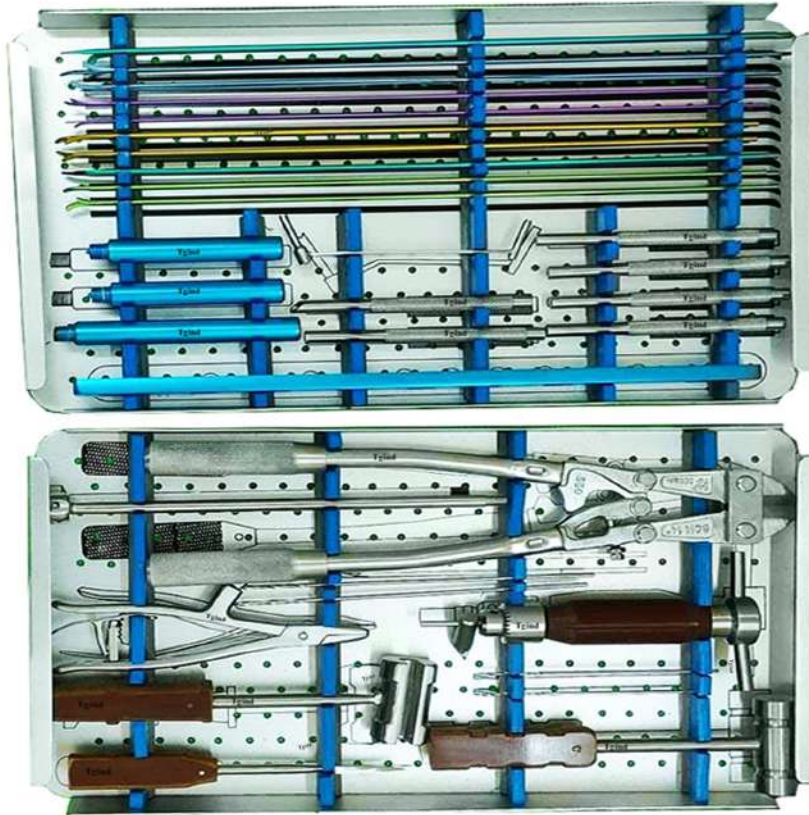

TG-REF:1341

PNF Instruments system Box Set

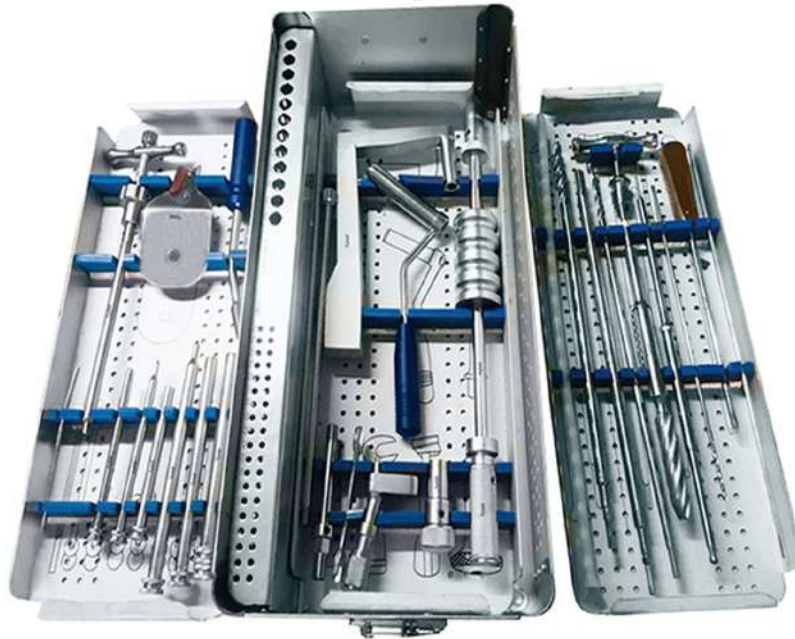

TG-REF:1342



TAHIR GROUP OF INDUSTRIES



+92-300-6669737



TAHIR GROUP OF INDUSTRIES



TGIND.COM



TAHIR GROUP OF INDUSTRIES



info@tgind.com

Interlocking Nail Instruments Set Tibia & Femur



TG-REF:1343

ACL/PCL Reconstruction Instruments Box

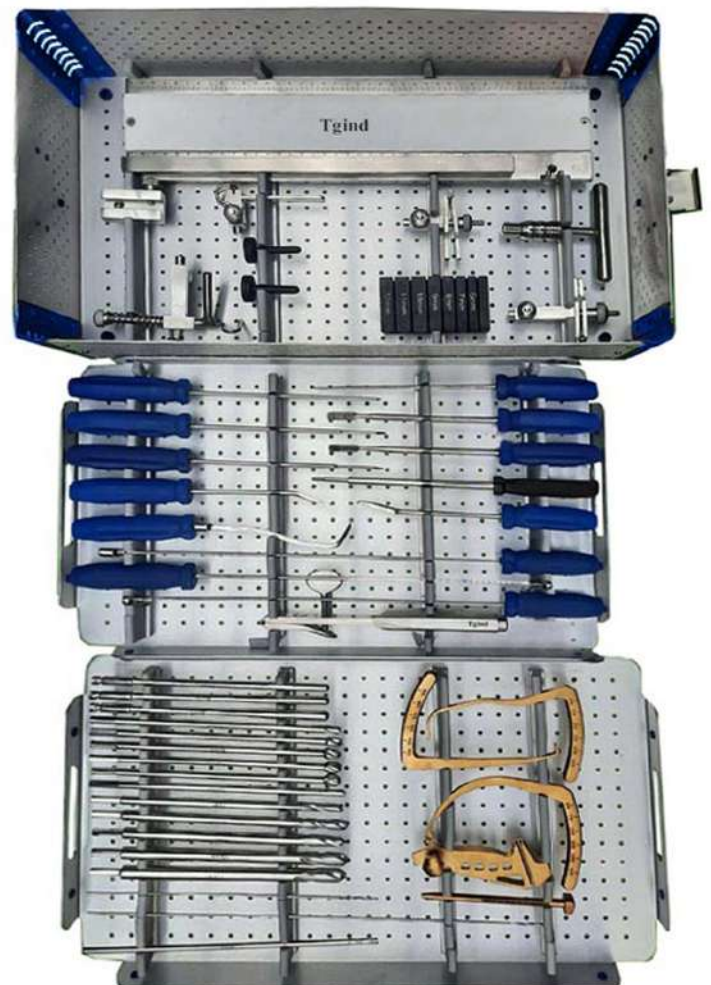

TG-REF:1344

Knee Replacement Kit Box

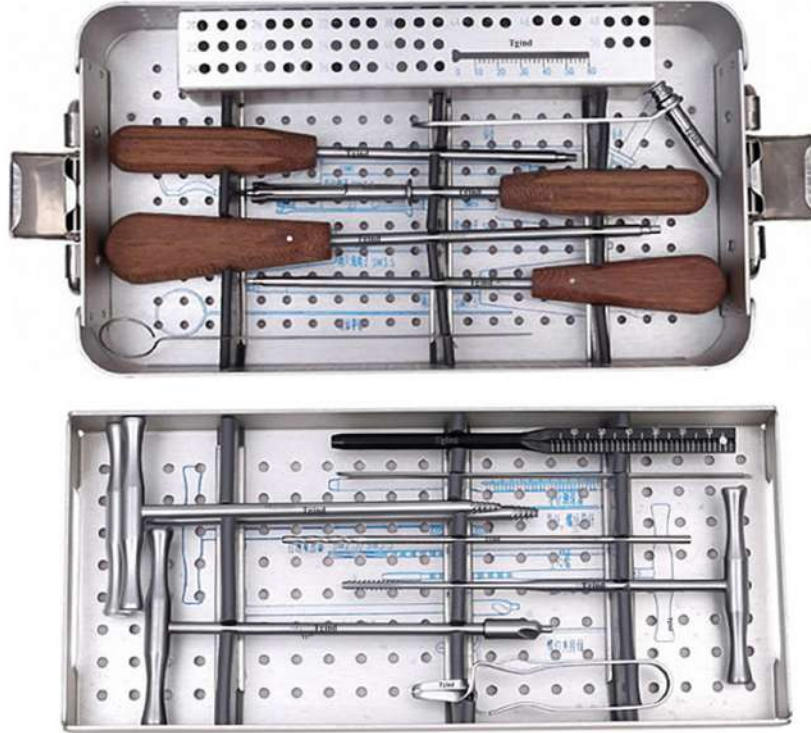

TG-REF:1345

Anterior Cervical Plate Instruments Set

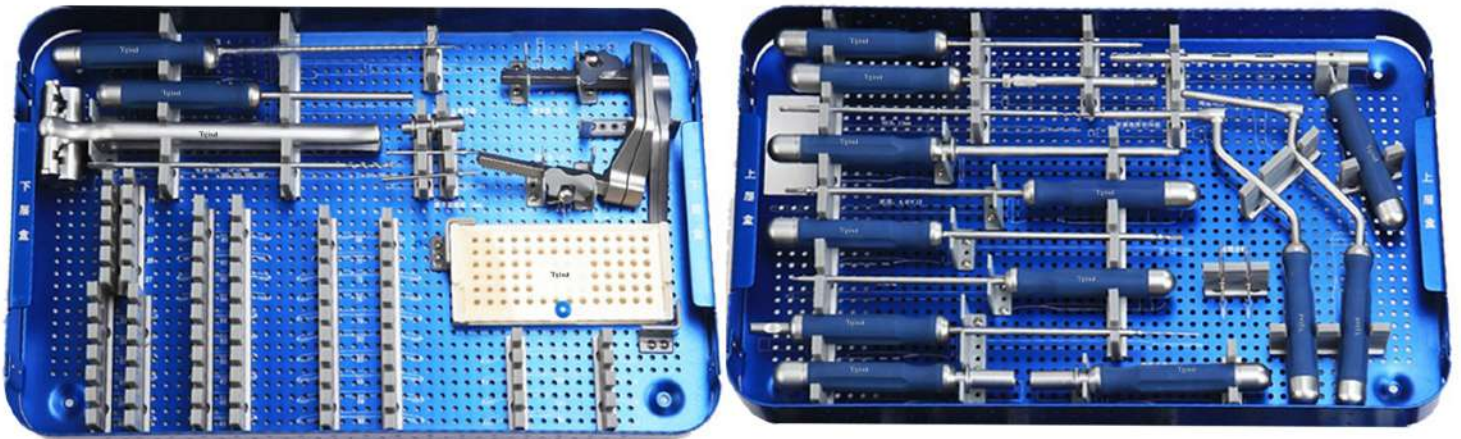

TG-REF:1346

Cardiac Surgery Instruments Set Of 121Pcs

Description



- 2 Pcs Mayo Scissors Curved 6.25"
- 2 Pcs Mayo Scissors Straight 6.25"
- 2 Pcs Metzenbaum Scissors Curved 7"
- 4 Pcs Baumgartner Wire Twister 8"
- 4 Pcs DeBakey Forceps 7"
- 4 Pcs DeBakey Forceps 9"
- 4 Pcs Mayo Hegar Needle Holder 8"
- 6 Pcs Mosquito Forceps 5" Curved
- 6 Pcs Mosquito Forceps 5" Straight
- 6 Pcs Crile Forceps 5.5" Curved
- 6 Pcs Crile Forceps 6.25" Straight
- 2 Pcs Pottt Point Mixer 5.25"
- 6 Pcs Allis Tissue Forceps 6" 5x6
- 6 Pcs Kelly Forceps 6.25" Curved
- 4 Pcs Kelly Forceps 8" Curved
- 6 Pcs Kocher Forceps 6.25" Straight (Rochester Pean)
- 4 Pcs Kocher Forceps 8" Straight (Rochester Pean)
- 2 Pcs Schmidt Tonsil Forceps 7.5" Curved
- 4 Pcs Lahey Gall Duct Forceps 7.5"
- 4 Pcs Sponge Forceps 9.5"
- 4 Pcs Tube Clamp 8"
- 6 Pcs Towel Clamp Non Penetrating 5.5"
- 6 Pcs Towel Clamp 5.5" (Backhaus)
- 2 Pcs Fogarty Clamp Angular 61mm 8 1/4"
- 2 Pcs Fogarty Clamp Angular 86mm 9 1/4"
- 2 Pcs Fogarty Clamp Straight 61mm 11 1/2"
- 1 Finochetto Retractor
- 2 Right Angle Retractor Medium
- 1 Castroviejo Needle Holder TC Straight
- 1 Castroviejo Scissors TC
- 1 Scalpel Handle #3
- 1 Scalpel Handle #4
- 2 DeBakey Bulldog Straight
- 2 DeBakey Bulldog Straight
- 1 Satinsky-DeBAKEY Clamps Surgical Vascular Forceps 9"
- 1 Cooley Derra Pediatric Vascular Clamp 6.5"
- 1 Lambert-Key Vascular Aortic Anastomosis Clamp 8.5"
- 1 DEBAKEY Peripheral Vascular Clamp Forceps 9"

TG-REF:1347

Major Cardio Surgery Instruments Box

Description



- 1 Poole Suction Tube Straight with Removable Outer Tube 30 Fr
- 1 DeBakey Tangential Occlusion Clamp Size 10 1/4"
- 1 Ferguson Frazier Suction Tube 9 Fr
- 1 Harrington Retractor 12" - 1 1/2" Blade
- 1 Harrington Retractor 12" - 2 1/2" Blade
- 1 Cushing Vein and Nerve Retractor 9"
- 10 Providence Hospital Hemostatic Forceps Curved 5 1/2"
- 1 Potts Smith Scissors Angled on Side 60° 7 1/2"
- 1 Potts Smith Scissors Angled on Side 45° 7 1/2"
- 1 Knife Handle No 3L
- 1 Metzenbaum Scissors Delicate Curved 7" - Tungsten Carbide
- 4 Allis Tissue Forceps 4x3 Teeth 6"
- 1 Forcep Instrument Holder 12"
- 1 Instrument Holder 10"
- 1 Instrument Holder 8"
- 1 Knife Handle No 7
- 2 Knife Handle No 4
- 2 Knife Handle No 3
- 2 Thumb Tissue Forceps 1x2 Teeth 8"
- 1 DeBakey Multipurpose Clamp Angle 60 - 4 cm Jaws Size 9 1/2"
- 1 Freer Elevator Double Ended With Blunt Sharp Blades 7" 5mm Wide
- 2 Volkman Retractor Hollow Grip Handle 10" 3" X 2 1/2"
- 1 Kelly Retractor Hollow Grip Handle 10" 2" X 1 1/2"
- 2 Deaver Retractor Plain Handle 3" X 12"
- 1 Ribbon Retractor Malleable 13" X 1 1/2"
- 1 Potts Smith Tissue Forceps 1x2 Teeth 9 1/2"
- 2 Ramel Thoracic Forceps Fully Curved 2 3/8" Long Jaws 9"
- 1 DeBakey Multipurpose Clamp Angle 60 - 6.5 cm Jaws Size 9 1/2"
- 4 Schmidt Tonsil Hemostatic Forceps 7 1/2" Slight Curved
- 1 DeBakey Vascular Clamp For Aortic Aneurysm Slightly Curved 10 cm Size 12 1/2"
- 1 DeBakey Serib Ligature Carrier Size 10 1/4"
- 2 Glover Bulldog Clamp With Spring Adjusting Screw Curved Size 6cm - Jaws 2.5 cm
- 2 Glover Bulldog Clamp With Spring Adjusting Screw Straight Size 6cm - Jaws 2.5 cm
- 1 DeBakey Thoracic Tissue Forceps 2.5mm wide Tips 9 1/2"
- 1 Ribbon Retractor Malleable 13" X 1.0"
- 1 Richardson Retractor Hollow Grip Handle 9 1/2" 1 1/2" X 1 1/2"
- 1 Richardson Retractor Hollow Grip Handle 9 1/2" 1" X 3/4"
- 1 DeBakey Thoracic Tissue Forceps 2.5mm wide Tips 6"
- 1 Potts Smith Scissors Angled on Side 25° 7 1/2"
- 1 Metzenbaum Scissors 7" Curved Tungsten Carbide Super Sharp
- 4 Rochester Ochsner (Kocher) Forceps Straight 1x2 Teeth 10"
- 2 Russian Tissue Forceps 8"
- 2 Thumb Tissue Forceps 1x2 Teeth 5 1/2"
- 2 Dressing Forceps 5 1/2" Serrated
- 8 Backhaus Towel Clamp 5 1/4"
- 2 Babcock Intestinal Forceps 8"
- 4 Babcock Intestinal Forceps 6 1/4"
- 2 Allis Wittauer Tissue Forceps 5X6 Teeth 10"
- 3 Foerster Sponges Forceps Straight 9 1/2" Serrated Jaws
- 2 Mixer Hemostatic Forceps 9" Fully Curved Serrated
- 2 Adson Forceps 4 3/4" Micro with 1x2 Teeth
- 4 Rochester Pean Forceps 10" Curved
- 6 Rochester Pean Forceps 5 1/4" Curved
- 10 Kelly Hemostatic Forceps 5 1/2" Curved
- 10 Kelly Hemostatic Forceps 5 1/2" Straight
- 6 Halstead Mosquito Forceps Curved 4 3/4"
- 6 Halstead Mosquito Forceps Straight 4 3/4"
- 1 Metzenbaum Dissecting Scissors Standard Curved 7"
- 1 Deaver Retractor Plain Handle 1" X 13"
- 1 Yankauer Suction Tube 20 Fr Standard Size
- 2 Mayo Hegar Needle Holder Serrated 10 1/2" Tungsten Carbide
- 2 Mayo Hegar Needle Holder Serrated 8" Tungsten Carbide
- 1 Metzenbaum Scissors Standard Curved 9" - Tungsten Carbide
- 1 Metzenbaum Scissors Standard Straight 9" - Tungsten Carbide
- 4 Lahey Gall Duct Forceps 7 1/2"
- 2 Coelet Retractor Double Ended 7 1/2"
- 1 Deaver Retractor Plain Handle 2" X 9"
- 2 Mayo Dissecting Scissors Straight 5 3/4"
- 1 Deaver Retractor Plain Handle 1" X 9"
- 1 Ribbon Retractor Malleable 13" X 2.0"
- 1 Ribbon Retractor Malleable 13" X 1.25"
- 1 Balfour Abdominal Retractor 7" Spread Standard
- 1 Sterilization Box

TG-REF:1348

Major Bypass Surgery Instruments Set Box

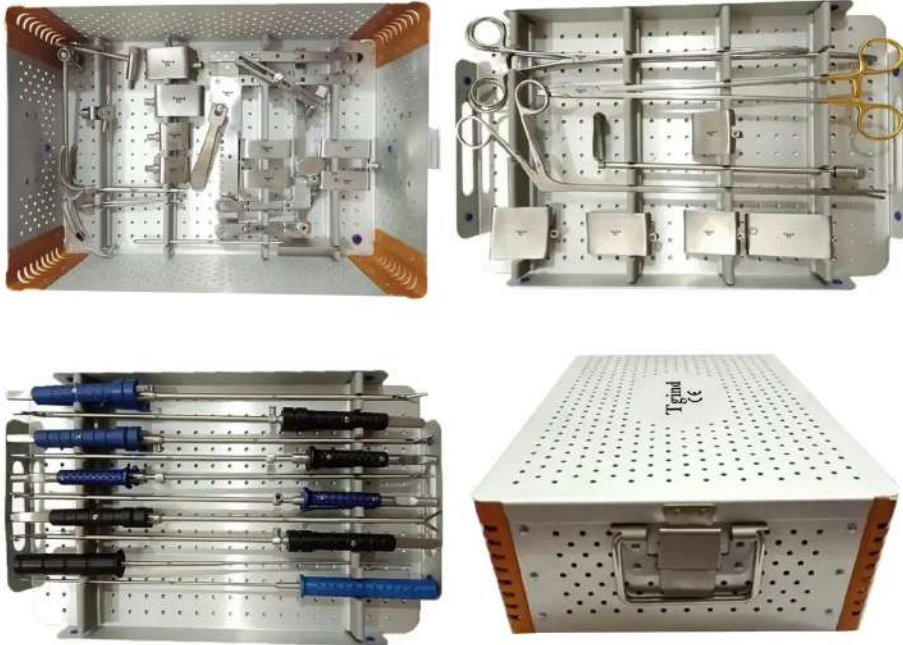

Description

- 2 Pcs Mayo Scissors Curved 6.25"
- 2 Pcs Mayo Scissors Straight 6.25"
- 2 Pcs Metzenbaum Scissors Curved 7"
- 4 Pcs Baumgartner Wire Twister 8"
- 4 Pcs DeBakey Forceps 7"
- 4 Pcs DeBakey Forceps 9"
- 4 Pcs Mayo Hegar Needle Holder 8"
- 6 Pcs Mosquito Forceps 5" Curved
- 6 Pcs Mosquito Forceps 5" Straight
- 6 Pcs Crile Forceps 5.5" Curved
- 6 Pcs Crile Forceps 6.25" Straight
- 2 Pcs Petit Point Mixer 5.25"
- 6 Pcs Allis Tissue Forceps 6" 5x6
- 6 Pcs Kelly Forceps 6.25" Curved
- 4 Pcs Kelly Forceps 8" Curved
- 6 Pcs Kocher Forceps 6.25" Straight (Rochester Pear)
- 4 Pcs Kocher Forceps 8" Straight (Rochester Pear)
- 2 Pcs Schmidt Tonsil Forceps 7.5" Curved
- 4 Pcs Lahey Gall Duct Forceps 7.5"
- 4 Pcs Sponge Forceps 9.5"
- 4 Pcs Tube Clamp 8"
- 6 Pcs Towel Clamp Non Penetrating 5.5"
- 6 Pcs Towel Clamp 5.5" (Backhaus)
- 2 Pcs Fogarty Clamp Angular 61mm 8 1/4"
- 2 Pcs Fogarty Clamp Angular 86mm 9 1/4"
- 2 Pcs Fogarty Clamp Straight 61mm 11 1/4"
- 1 Finochelo Retractor
- 2 Right Angle Retractor Medium
- 1 Castroviejo Needle Holder TC Straight
- 1 Castroviejo Scissors TC
- 1 Scalpel Handle #3
- 1 Scalpel Handle #4
- 2 DeBakey Bulldog Straight
- 2 DeBakey Bulldog Straight
- 1 Satinsky-DeBAKEY Clamps Surgical Vascular Forceps 9"
- 1 Cooley Derra Pediatric Vascular Clamp 6.5"
- 1 Lambert-Kay Vascular Aortic Anastomosis Clamp 8.5"
- 1 DEBAKEY Peripheral Vascular Clamp Forceps 9"

TG-REF:1349

Coronary Artery Bypass Graft Cardiovascular Set



Description

- 1) MIS DeBakey Forceps - Straight 1mm tips, 5mm Shaft, 6.75" (17cm) Working Length, Round Squeeze-Handle, (30cm)
- 2) Jacobsen Spiral Line Forceps 21cm TC
- 3) DeBakey Forceps 18.5cm straight 1x2 TC
- 4) Platform Forceps 0.5mm 21cm TC Coated
- 5) IMA Forceps 1mm Micro 0.25mm Teeth 45 Degree Angle TC Platform 21cm
- 6) Aortic Anastomosis Clamp 33mm jaw 35mm Tip Angled Shank Atraumatic 18cm
- 7) Lambert Key Aorta Clamp 33mm Tip jaw 45mm Angled Shank Atraumatic 26cm
- 8) Hunter Satinsky Aorta Clamp 33mm Tip jaw 75mm Deeply Angled Shank Atraumatic 22cm

TG-REF:1350



Tympanoplasty Instruments Set, Micro Ear Surgery Ent instruments Black Coated



Description

1. SuperMicro Ear Forceps Serrated 0.6x2.0mm Effective Length 75mm
2. SuperMicro Ear Forceps, Malleus Nipper, 0.8x2.0mm Effective Length 75mm
3. Ear Forceps Serrated Straight 1.0x4.2mm Effective Length 75mm
4. SuperMicro Ear Forceps Oval Cupped Jaw 0.6x0.8mm, Effective Length 75mm
5. Hartmann Ear Forceps Serrated Open close Tip Type
6. Micro Ear Forceps, oval copper jaws 0.8x1.0mm Effective Length 75mm
7. Shea Ear Scissors straight blade 6.0mm 75mm
8. Volkman Retractor, 3 Prongs, Blunt
9. Lempert Ear Speculum, for inner ear, nasalspeculum type
10. Asago ear speculum, inner diameter 4mm Brass
11. Tissue Forceps, Hook Tip Width 0.6mm length 130mm
12. Dissecting Forceps for surgical hook tip width 1.5mm length 130mm
13. Tissue Forceps, no hook, tip width 0.6mm length 130mm
14. Dissecting Forceps, For Surgical, No hook, Tip Width 1.5mm length 130mm
15. Lagenbeck Periosteum Raspatory, width 6.5mm
16. Lagenbeck Periosteal elevator
17. Lucae Ear Forceps, no Hook
18. Wullstein Raspatory, Curved
19. Micro iris Scissor Straight Supercut + Tungsten Carbide 115mm
20. Micro Iris Scissor Curved Supercut + Tungsten Carbide 115mm
21. Small pick left length 180mm
22. Round Knife, straight 2.5mm Diameter
23. Sickle Knife for Stapedius Muscle
24. Round Knife 45° Curved Diameter 1.0mm
25. Rosen Probe 90° tip length 0.3mm
26. Pick, Medium, Right, Length 180mm
27. Rosen Probe 90° Tip length 0.6mm
28. Pick, Medium, Left, Length 180mm
29. Rosen Probe, 90° Tip Length 1.0mm
30. Stainless Steel Sterilizing Box

TG-REF:1351

Aricular/microtia Repair Instruments.



Description

- Detail of Aricular/microtia repair instruments:
- MCINDOE DRESSING FORCEPS, 15CM, SERRATED 1
 - GILLIES TISSUE FORCEPS, 15CM, 1X2 TEETH 1
 - SEAN MILLER RETRACTOR, 16CM, BLUNT 2
 - JACKSON TRACHEAL RETRACTOR, 17CM, DOUBLE ENDED 2
 - JOSEPH SKIN HOOK, 16CM, SINGLE PRONG, SHARP 1
 - SUPERCUT MAYO SCISSORS, 14CM, CURVED 1
 - LANGENBECK RETRACTOR, 10MM WIDE X 40MM DEEP 21CM 2
 - LANGENBECK RETRACTOR, 13MM WIDE X 42MM DEEP 21CM 2
 - KOCHER RETRACTOR #2, 13MM WIDE X 60MM DEEP, 21CM 2
 - COHEN PERIOSTEAL ELEVATOR / RETRACTOR, 24CM, 6MM, DOUBLE ENDED, BLUNT 1
 - 26CM, DOUBLE ENDED 1
 - DINGMAN PERIOSTEAL ELEVATOR / RASPATORY, 16CM, 47MM, SHARP / BLUNT 1
 - SCALPEL HANDLE #3/4
 - BACKHAUS CLAMP FORCEPS 13CM
 - MAYO HEGAR NEEDLE HOLDER TC 14CM

TG-REF:1352

Cleft Palate Instruments Set



TG-REF:1353

COCHLEAR Implant Instruments (59-PCS)



Description

- 1 Galipot 4"
- 2 Bowl Cup 6"
- 3 Skin retractor
- 4 Fascia pressure forceps
- 5 Vienna Nasal speculum Medium
- 6 Rongeur Plier 15cm
- 7 Self-retaining retractor 2X3 Blunt
- 8 Mayo hegar needle holder
- 9 Goldman Fox scissors 13cm
- 10 Semken Tweezer Toothed 15cm
- 11 Mosquito Forceps Straight 12.5cm
- 12 Scalpel Handle No#3
- 13 Scalpel Handle No#4
- 14 Noyes Spring scissors Straight 11.5cm
- 15 Bellucci Micro Ear Scissors curved left sharp shaft:8cm/jaw 4.0mm
- 16 Bellucci Micro Ear Scissors Straight Sharp/Blunt shaft:6cm/jaw 4.0mm
- 17 Hartman Micro Forceps 8.5cm/14cm
- 18 Iris scissors
- 19 Malleus ripper Size 11cm/ Jaw 9mm
- 20 Mayo scissors; 17cm
- 21 Jacobson forceps (fine tip) 15cm
- 22 Lempert periosteum elevator 18cm
- 23 Volkman curette 17cm
- 24 Joseph Hook
- 25 Spare Hook
- 26 Needle Hook
- 27 microdissectors Probe angled 90°/#13
- 28 microdissectors Hook Semi Sharp 45°/#13
- 29 microdissectors Needle semi Sharp #9
- 30 Toothed Forceps 15cm
- 31 Frazier suction tubes Set 4.0mm 3.3mm 2.67mm
- 32 Baron suction irrigators 3pcs Set 3FR,5FR,7FR

TG-REF:1354

Craniotomy Surgery Instruments Set

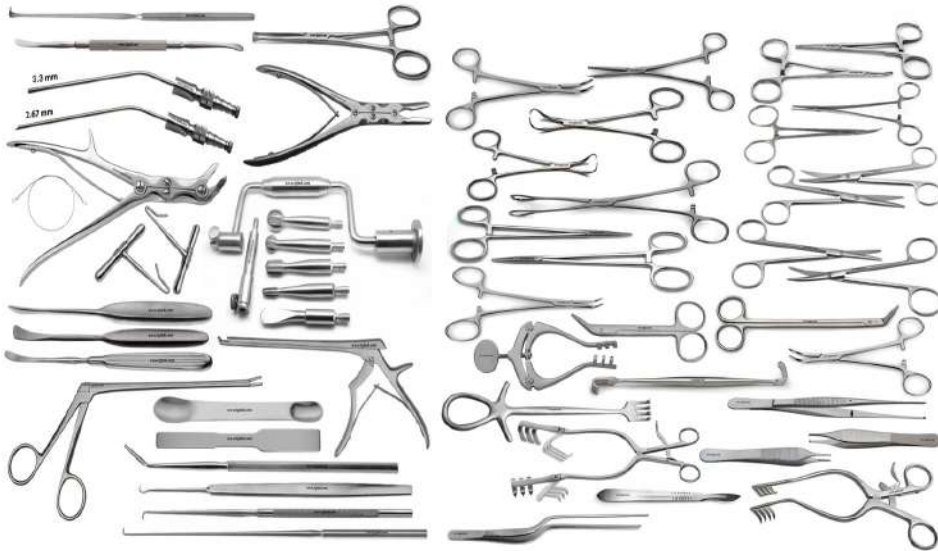

Description

- 1 Knife handle No 3
- 2 Mayo Dissecting scissors 5 1/2" (14 cm), str, Carb-N-Sert Blades
- 3 Mayo Dissecting scissors 5 1/2" (14 cm), Cvd, Carb-N-Sert Blades
- 4 Metzenbaum Scissors 7" (17.8 cm), Cvd, Carb-N-Sert Blades
- 5 Potts-smith Scissors 7 1/2" (19.1 cm), 25 angle 1 Pcs
- 6 Adson scissors 6 1/4" (15.9 cm), str. Sharp point
- 7 Metzenbaum Scissors 7" (17.8 cm), str. Carb-N-Sert Blades
- 8 Adson Dressing Forceps 4 3/4" (12.1 cm) , Serr. 1 Pcs
- 9 Adson Dressing Forceps 4 3/4" (12.1 cm) , 1x2 T
- 10 Cushing Tissue Forceps 7" (17.8 cm), 1x2 teeth 1 Pcs
- 11 Adson Bayonet Forceps 8 1/4" (21 cm), serr. 1 Pcs
- 12 Halsted Mosquito Forceps 5" (12.7 cm) str. Delicate
- 13 Halsted Mosquito Forceps 5" (12.7 cm) Cvd. Delicate
- 14 Dandy Scalp Hemostat 5 1/2" (14 cm) 12 Pcs
- 15 Rochester-Ochsner Forceps 6 1/4" (15.9 cm) , str
- 16 Backhaus Towel clamp 3 1/2" (8.9 cm) 8 Pcs
- 17 Backhaus Towel clamp 5 1/4" (13.3 cm) 8 Pcs
- 18 Forster Sponge Forceps 9 1/2" (24.1 cm), Str. Serr.
- 19 Crile-wood Needle holder 6" (15.2 cm), Carb-N-Sert Jaw
- 20 Crile-wood Needle holder 7" (17.8 cm), Carb-N-Sert Jaw
- 21 wire cutting Scissors 4 3/4" (12.1 cm) angular 1 Pcs
- 22 Jansen-wagner Retractor 5" (12.7") , blunt 1 Pcs
- 23 Senn Retractor 6 3/8" (16.2 cm), Double end, Sharp
- 24 Murphy Retractor 7 1/2" (19.1 cm) 4 prong, sharp
- 25 Beckman Retractor 12 1/2" (31.8 cm) , sharp
- 26 Adson Retractor 7 1/2" (19.1 cm), Sharp
- 27 Allis Tissue Forceps 6" (15.2 cm) 2 Pcs
- 28 Freer Elevator 7" (17.8 cm) double end 1 Pcs
- 29 Frazier Ferguson Suction Tube, 7 Fr (2.3 mm)
- 30 Frazier Ferguson Suction Tube, 9 Fr (3 mm)
- 31 Olivecrona Rongeur 8.5" (22cm) 1 Pcs
- 32 Stille-Luer Rongeur 9" (22.9 cm), angled
- 33 Cushing perforator Drill Set
- 34 Gigli Saw 20" (50.8 cm) 2 Pcs
- 35 Bailey Gigli saw Guide 12" (30.5 cm)
- 36 Luer Rongeur 7" (17.8 cm), str
- 37 Millex-Kerrison Cervical Rongeur 7" (17.8 cm), 3mm Bite 40 degree Forward
- 38 Scoville Brain Spatula 8" (20.3 cm)
- 39 Cushing Spatula Spoon 6 3/4" (17.1 cm)
- 40 Frazier Dura Separator 6 1/2" (16.5 cm)
- 41 Frazier Dura Hook 5" (12.7 cm), sharp
- 42 Dandy Nerve Hook 9" (22.9 cm), str
- 43 Love Nerve Retractor 8 1/2" (21.6 cm), Str angled 45 degree
- 44 Hoen Dura Separator 6" / 45d
- 45 Cushing Little Joker Periosteal Elevator 7 1/2" (19.1 cm)
- 46 Langenbeck Periosteal Elevator 7 1/2" (19.1 cm) 1 Pcs
- 47 Adson Periosteal Elevator 6 1/2" (16.5 cm), blunt
- 48 Kelly Forceps STR 14cm
- 49 Kelly Forceps Cvd 14cm
- 50 Halsted Kocher Forceps Str 12.5cm

TG-REF:1355

MASTOID TYMPANOPLASTY SET



Description

- 1 Wild Aural Forceps Large 13cm
- 2 FAGGE Aural Bayonet Forceps 12cm
- 3 ADSON Plain Forceps 11cm
- 4 ADSON Forceps With 1x2 Teeth 11cm
- 5 HARTMAN Aural Forceps 3 1/2", smooth, 4mm jaw
- 6 OSSICLE Holding Forceps 4x5 teeth 11cm
- 7 TILLEY Aural Forceps 14cm Serr angled
- 8 LEMPERT Rongeur Curved 15cm
- 9 PLESTER Self Retaining Retractor 2x2 Prongs
- 10 WULLSTEIN Self Retaining Retractor 3x3 Prongs
- 11 WULLSTEIN Self Retaining Retractor 4x4 Prongs
- 12 PLESTER JANSEN Retractor Solid Blade Left 5.5" 14mm
- 13 PLESTER JANSEN Retractor Solid Blade Right 5.5" 14mm
- 14 GLEGG Aural Snare 23cm
- 15 JANSEN Chisel 14cm
- 16 JANSEN Osteotome 14cm
- 17 JENKINS Gouge 14cm
- 18 Cone Self Retaining Retractor Blunt 3x4 Prongs
- 19 LEMPERT Mastoid Curette
- 20 FARABEUF Elevator Curved
- 21 KERRISON Bone Punch 90d up/ 20cm
- 22 HOUSES Graft Press Forceps 14cm / jaw 26mm
- 23 MASTOID Suction Tube 6FR/8FR/10FR
- 24 Baron Suction Tube Set 4FR
- 25 Micro Aural Crocodile Forceps Up 14cm
- 26 Micro Crocodile Cup Forceps Oval cup Straight
- 27 Micro Crocodile Scissors Fine Straight
- 28 Frazier Suction Tube 3.3mm (2.67mm)

TG-REF:1356



TAHIR GROUP OF INDUSTRIES



+92-300-6669737



TAHIR GROUP OF INDUSTRIES



TGIND.COM



TAHIR GROUP OF INDUSTRIES



info@tgind.com

Fess Surgery Instruments Set



Description

- 1 Wild Aural Forceps Large 13cm
- 2 FAGGE Aural Bayonet Forceps 12cm
- 3 ADSON Plain Forceps 11cm
- 4 ADSON Forceps With 1x2 Teeth 11cm
- 5 HARTMAN Aural Forceps 3 1/2", smooth, 4mm jaw
- 6 OSSICLE Holding Forceps 4x5 teeth 11cm
- 7 TILLEY Aural Forceps 14cm Serr angled
- 8 LEMPERT Rongeur Curved 15cm
- 9 PLESTER Self Retaining Retractor 2x2 Prongs
- 10 WULLSTEIN Self Retaining Retractor 3x3 Prongs
- 11 WULLSTEIN Self Retaining Retractor 4x4 Prongs
- 12 PLESTER JANSEN Retractor Solid Blade Left 5.5" 14mm
- 13 PLESTER JANSEN Retractor Solid Blade Right 5.5" 14mm
- 14 GLEGG Aural Snare 23cm
- 15 JANSEN Chisel 14cm
- 16 JANSEN Osteotome 14cm
- 17 JENKINS Gouge 14cm
- 18 Cone Self Retaining Retractor Blunt 3x4 Prongs
- 19 LEMPERET Mastoid Curette
- 20 FARABEU Elevator Curved
- 21 KERRISON Bone Punch 90d up/ 20cm
- 22 HOUSES Graft Press Forceps 14cm / jaw 20mm
- 23 MASTOID Suction Tube 6FR/8FR/10FR
- 24 Baron Suction Tube Set 4FR
- 25 Micro Aural Crocodile Forceps Up 14cm
- 26 Micro Crocodile Cup Forceps Oval cup Straight
- 27 Micro Crocodile Scissors Fine Straight
- 28 Frazier Suction Tube 3.3mm /2.67mm

TG-REF:1357

FACE AND FOREHEAD LIFT (SOLZ SET)



Description

- 1-SCALPEL BLADES #15
- 2-SCALPEL HANDLE, #7 fits #9, 10, 11, 12, 12D, 13, 15, 15C blades(2pieces)
- 3-ADSON BROWN DELICATE TISSUE FORCEPS, 12CM, 7X7 TEETH, STRAIGHT
- 4-BABY CRILE WOOD T.C. NEEDLE HOLDER, 15CM "HM" Tungsten Carbide
- 5-BACKHAUS TOWEL CLAMP, 8.5CM
- 6-DEMARTEL SCALP FLAP FORCEPS, 14CM
- 7-FARABEU BABY RETRACTORS, 12CM, DOUBLE ENDED, SET OF 2
- 8-GILLIES DURA AND SKIN RETRACTOR HOOK, 19CM, SMALL
- 9-GUBISCH T.C. NEEDLE HOLDER, 12.5CM, EXTRA FINE "HM" Tungsten Carbide
- 10-IRIS SUPERCUT SCISSORS, 11.5CM, CURVED
- 11-JOSEPH DELICATE RETRACTOR, 17CM, 2 PRONG, 5MM, SHARP
- 12-LANGENBECK KOECHER RETRACTOR #13, 15MM WIDE X 80MM DEEP, 21CM
- 13-MICRO ADSON FORCEPS, 12CM, 1X2 TEETH 0.8mm tips
- 14-PITANGUY FACELIFT MARKER, 16CM, 5MM WIDE
- 15-SELECT TISSUE FORCEPS, 20CM, 1X2 TEETH extremely fine
- 16-SOLZ "GOLD TIP" SUPERCUT SCISSORS, 20CM, CURVED, SLIGHT BEVEL ON SHANK
- 17-SOLZ RACKET RETRACTOR, 12.5CM, 45X100MM
- 18-SUPERCUT MAYO SCISSORS, 14CM, STRAIGHT
- 19-WALTER RETRACTOR, 19CM, 4 PRONGS,
- 20 kidney tray
- 21 bowl cup
- 22 skin grafting handle
- 23 Barraquer Deweckwer Iris Scissors

TG-REF:1358



Nasal Surgery Instruments Set



Description

- 1 Scalpel handle #7
- 2 Adson Tissue Forceps 12cm
- 3 Adson Tissue Forceps 1x2 toothed 12cm
- 4 Nasal Speculas Killian 14cm/35mm
- 5 Nasal Speculas Killian 14cm/50mm
- 6 Nasal Speculas Killian 14cm/75mm
- 7 Nasal Speculas Killian 14cm/85mm
- 8 Hartmann Forceps 8.5cm/2.0mm
- 9 Weil-Blakesley Nasal Forceps Straight 12cm
- 10 Takahashi Forceps 19cm/120mm
- 11 Freer Elevator Double End (sharp and blunt blade)
- 12 Elevator Cottle 9"
- 13 Chisel Freer Straight 4mm wide
- 14 Chisel Freer Curved 4 mm
- 15 Hajek Septum Chisel 4 mm
- 16 Ballenger Swivel Knife 21cm/4mm
- 17 Metzenbaum Scissors, Curved 15cm
- 18 Stevens (tenotomy) Scissors, Straight 12cm
- 19 Cottle Columella Clamp 10cm
- 20 Cottle Lower Lateral Forceps 15cm
- 21 Frazier Suction Tube, medium angle, 100 mm length
- 22 Brown Needle Holder 12cm
- 23 Jansen-Middleton Cutting Forceps 19cm/Jaw 4mm
- 24 Cottle Mallet 20cm

TG-REF:1359

Septoplasty Recovery Set

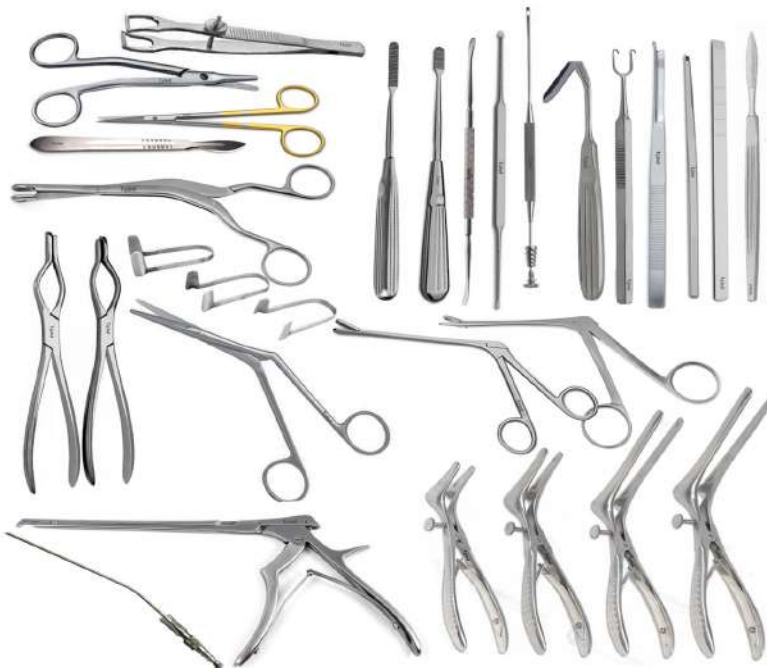

Description

- 1 Scalpal Handle #4
- 2 Cottle Nasal Knife Double Edge 15cm
- 3 Joseph Plastic Scissors 16cm
- 4 Walter Scissors Angled 10cm
- 5 Cottle Chisel Straight 15cm
- 6 Cottle Osteotomy Straight 18cm
- 7 Masing Chisel With Guard Straight 18cm
- 8 Cottle Alar Retractor 14cm 2 prong
- 9 Lucs Nasal Forceps 19cm/fig2
- 10 Aufrecht Retractor 50mm Blade
- 11 Suction Elevator Bay, 22cm/3.0mm
- 12 Masing Double Elevator 18cm
- 13 Freer Elevator 8"
- 14 JOSEPH Nasal Rasp Fine 18cm
- 15 Cottle Masing Nasal Rasp 21m
- 16 Walsham Septum Forceps Right
- 17 Walsham Septum Forceps Left
- 18 Thudicum Nasal Speculum Small Medium Large
- 19 Nasal Speculas Killian 14cm/35mm
- 20 Nasal Speculas Killian 14cm/50mm
- 21 Nasal Speculas Killian 14cm/75mm
- 22 Nasal Speculas Killian 14cm/85mm
- 23 Blakesley Nasal Forceps Upward 45 Degree
- 24 Watson William Forceps 13cm/9.0mm
- 25 Frazier Suction Tube 100 mm length
- 26 Cottle Columella Forceps 10cm
- 27 Kerrison Forceps 40d down Cutting
- 28 Heymann Nasal Scissors Blunt/Serr 17cm

TG-REF:1360



ENT Surgery Instruments Set



Description

- Scalpel handle #3
- Metzenbaum Scissors Str TC
- Halsted Kocher forceps STR 12.5cm
- Halsted Kocher forceps CVD 12.5cm
- Crilewood Needle Holder TC 14cm
- Farabeuf Retractor set
- Nasal Speculum
- Ear Syringe
- Backhaus Towel Clip 13cm
- Dressing Forceps 15cm
- Semken Forceps 15cm
- Lucae Bayonet Forceps 1x2 14cm
- Yanuker Cannula 21cm
- Kelly Forceps Curved 14cm
- Kidney Tray
- Galipot 4"

TG-REF:1361

Neck Dissecting Instruments Set



Description

- | | |
|---|--|
| 1 E-Z Lock Instrument Holder 10" x 2-1/2" | 30 Lorna-Edna Towel Clamp 5-1/4" |
| 2 Sterilization Container 23" x 11" x 5" | 31 Backhaus Towel Clamp 5-1/4" |
| 3 Sterilization Wire Basket 20-1/2" x 10" x 3", 3" | 32 Cushing Nerve Retractor 9" |
| 4 TC Metzenbaum Scissor Curved 5-3/4" | 33 Adson Forceps Serrated 4-3/4" |
| 5 TC Metzenbaum Scissor Straight 5-3/4" | 34 Adson Kocher Forceps 1x2 Teeth 4-3/4" |
| 6 TC Mayo Scissor Straight 6-3/4" | 35 DeBakey Forceps Straight 2mm, 6-1/4" |
| 7 TC Mayo Scissor Curved 6-3/4" | 36 Gemini Clamp, Delicate Angled 6-1/4" |
| 8 Halsted Mosquito Forceps Straight, 5" | 37 US Army Retractor Double End 8-1/4" |
| 9 Halsted Mosquito Forceps Curved, 5" | 38 Richardson Retractor 9-1/2" 1" x 1-1/4" |
| 10 Halsted Kocher Forceps Straight 12.5cm | 39 Volkman Retractor 4 Prongs 8-1/2" |
| 11 Rochester Pean Forceps Curved 6-1/4" 6" | 40 Senn Retractor Sharp 3 Prong 6-1/4" |
| 12 Rochester Pean Forceps Straight, 6-1/4" | 41 Stevens Tenotomy Scissor Blunt/Blunt 4-1/2" |
| 13 Crile Forceps Straight 5-1/2" | 42 Desmarres Lid Retractor Blade Blunt 12mm |
| 14 Crile Forceps Curved 5-1/2" | 43 Hurd Tonsil Dissector Round Tip 8-3/4" |
| 15 Lahey Traction Forceps 6-1/4" | 44 Foerster Sponge Forceps 9-1/2" |
| 16 Mixer Forceps Right Angle, 5-1/2" | 45 Bipolar Forceps 1mm, 7" |
| 17 Dressing Forceps Serrated 6" | 46 Foerster Sponge Forceps, Straight, Serrated, Satin Finish, 9-1/2" 3 |
| 18 Tissue Forceps 1x2 Teeth 6" | 47 Bipolar Forceps, |
| 19 TC Crile-Wood Needle Holder Serrated 6" | |
| 20 TC Mayo-Hegar Needle Holder Serrated 6" | |
| 21 Mosquito Forceps Curved Serrated, 5" 12 | |
| 22 Weitlaner Retractor 3x4 Blunt 4-1/2" | |
| 23 Babcock Intestinal Forceps 6-1/4" | |
| 24 Allis Tissue Forceps 4x5 Teeth 6" | |
| 25 Weitlaner-Beckman Retractor 3x4 Teeth, Sharp, 6" | |
| 26 Adson-Brown Forceps 4-3/4" | |
| 27 Freer Elevator Sharp/Blunt 7-3/4" | |
| 28 Gillies Skin Hook Large 4mm, 7" | |
| 29 Blair-Roiel Retractor 4 Prong 5-1/2" 1mm, 7" | |

TG-REF:1362

Tracheostomy Surgery Set



Description

Mayo Safety Pin
Langen Beck Retractor
Tracheal Dilating Forceps
Tracheal Retractor 2 Prongs
Tracheal Retractor 1 Prong
Metzenbaum Scissors Curved
GERALD Tissue Forceps
Dressing Scissors Blunt+Sharp
crile nerve hook
Crilewood Needle Hold
Allis Tissue Forceps
Backhouse Towel Forceps
B.P. Handle 3,4#
Debaquey Forceps TC 1
Yankur Tube
Ballenger Sponges Forceps Str 500
Weitlaner Retractor
Micro Halsted Mosquito Forceps Straight
Micro Halsted Mosquito Forceps Curved
Senn Muller Retractor Sharp blunt
3 Pieces Chevalier jackson tracheostomy Tube #6
4 Pieces Chevalier jackson tracheostomy Tube #7
3 Pieces Chevalier jackson tracheostomy Tube #8
Instruments Box

TG-REF:1363

Myringotomy Set



Description

4Buck Ear Curette, Size 1, Angled, Sharp
Fig. 1: Ø 1 mm
Fig. 2: Ø 2 mm
Fig. 3: Ø 2 mm
Fig. 4: Ø 3 mm
1 Blair Rollet Retractor
1 Mayo Hegar Needle Holder
1 Weitlaner Retractor
1 Farrior Ear Speculum, Size 1
1 Farrior Ear Speculum, Size 3
1 Farrior Ear Speculum, Size 5
1 Farrior Ear Speculum, Size 7
3PCS Frazier Suction Tube
1 Iris Scissors, Straight, Sharp, 4 1/2"
1 Farrell Twist Applicator, 6 1/2"
2 Lucae Bayonet Forceps, 5 1/2"
1 Wullstein Sickle Knife, 6"
1 Adson Tissue Forceps 1x2 Teeth, 4 3/4"
1 Adson plain forcep fine
1 sterilizing BOX

TG-REF:1364



Thoracotomy Surgery Instruments



TG-REF:1365

Rhinoplasty Surgery Instruments Set



TG-REF:1366



TAHIR GROUP OF INDUSTRIES



+92-300-6669737



TAHIR GROUP OF INDUSTRIES



TGIND.COM



TAHIR GROUP OF INDUSTRIES



info@tgind.com

Tonsillectomy & Adenoidectomy Instrument Set



Description

- 1 Hurd Dissector and Pillar Retractor
- 1 Gwyneven Tonsil Dissector
- 1 Negush Pusher
- 1 B.P Handle No.7
- 1 Irwan Moore Needle
- 1 Adenoid Curette
- 1 Love Uvula Retractor
- 1 Waugh Tonsil Dressing Forceps Toothed 8"
- 1 Davis Mouth Gag Set (1 Frame and 5 Blades)
- 1 Metzenbaum Scissors Curved 7"
- 1 White Tonsil Forceps Curved 9.5"
- 1 Tonsil Artery Forceps Curved 6"
- 1 Negus Tonsil Artery Forceps Curved
- 1 Negus Tonsil Artery Forceps Deep Curve
- 1 Crile Wood Needle Holder 6"
- 1 Denis Brown Tonsil Holding Forceps 200
- 1 Eve Tonsil Snare
- 1 Tongue Depressor
- 1 Yankauer Tonsil Suction Tube
- 1 Bipod Stand (2 Rods + 1 Plate)
- 1 STERILIZING BOX

TG-REF:1367

SMR Surgery Instruments Set Of 22Pcs



TG-REF:1368



TAHIR GROUP OF INDUSTRIES



+92-300-6669737



TAHIR GROUP OF INDUSTRIES



TGIND.COM



TAHIR GROUP OF INDUSTRIES



info@tgind.com

Ophthalmic Blepharoplasty Instruments Kit



Description

- 5Pcs Set Eyelid Retractor (8mm, 10mm, 12mm, 14mm, 16mm)
- 3Pcs Micro Surgery Tweezers
- X1 Castroviejo Needle Holder Slim Straight TC 18cm
- X1 Castroviejo Needle Holder Slim Curved TC 18cm
- X1 Debaque Tweezer TC 14cm
- X1 Backhaus Towel Clamp 13cm
- X1 Adson Tweezer 12cm
- X1 Adson Kocher 12cm
- X1 Joseph Skin Hook 6"
- X1 Fomon Retractor Flat Handle
- X1 Iris Scissor TC Straight 11.5cm
- X1 Iris Scissor TC Curved 11.5cm
- X1 Noyes Scissor Straight 11.5cm
- X1 Noyes Scissor Curved 11.5cm
- X1 Mosquito Forceps Straight 12.5cm
- X1 Mosquito Forceps Curved 12.5cm
- X1 Micro Halsted Kocher Straight 12.5cm
- X1 Micro Halsted Kocher Curved 12.5cm
- X1 Pean Forceps Curved 14cm
- X1 Corn Suture Tweezer 6"
- X1 Bowl Cup
- X1 Scalpel Handle #3

TG-REF:1369

SMR Surgery Instruments Set Of 22Pcs



Description

- 1 BARRAQUER WIRE SPECULUM SMALL
- 1 BARRAQUER WIRE SPECULUM LARGE
- 1 BOTVIN IRIS MICRO TISSUE FORCEPS 1X2 TEETH
- 1 COLIBRI TISSUE MICRO FORCEPS 1X2 TEETH, 0.4MM TYING PLATFORM
- 1 HARMS-COLIBRI TISSUE MICRO FORCEPS 1X2 TEETH, 0.12MM TYING PLATFORM
- 1 CASTROVIEJO CORNEOSCLERAL SCISSORS RIGHT
- 1 CASTROVIEJO CORNEOSCLERAL SCISSORS LEFT
- 1 WESTCOTT TENOTOMY SCISSORS BLUNT TIPS
- 1 UTRATA CAPSULORRHESIS FORCEPS W/ TRIANGULAR GRASPING TIPS
- 1 BISHOP HARMON MICRO TISSUE FORCEPS 1X2TEETH
- 1 EYE DRESSING FORCEPS SERRATED STRAIGHT
- 1 EYE TISSUE MICRO FORCEPS 1X2TEETH STRAIGHT
- 1 ADSON TISSUE MICRO FORCEPS 1X2TEETH STRAIGHT
- 1 CASTROVIEJO NEEDLE HOLDER CURVED NO LOCK
- 1 CASTROVIEJO NEEDLE HOLDER CURVED WITH LOCK
- 1 JONES TOWEL CLAMP WITH CROSS ACTION
- 1 HALSTEAD MOSQUITO FORCEPS STRAIGHT
- 1 HALSTEAD MOSQUITO FORCEPS CURVED
- 1 METZENABUM SCISSORS CURVED 7"
- 1 EYE IRIS SCISSORS W/ LARGE RING STRAIGHT

TG-REF:1370



TAHIR GROUP OF INDUSTRIES



+92-300-6669737



TAHIR GROUP OF INDUSTRIES



TGIND.COM



TAHIR GROUP OF INDUSTRIES



info@tgind.com

21Pcs Eye Cataract Set Instruments Titanium

Description



- x1 Corneal Scissors
Slightly curved, 14mm in blade length, 118mm in total length
- x1 Cataract Scissors Membrane
Curved tips, 16mm in blade length, 117mm in total length
- x1 Micro-needle Holder
Curved, 114mm in total length
- x1 Vannas Scissors Straight
Straight, 8mm in blade length, 85mm in total length
- x1 Vannas Scissors Straight
Curved, 8mm in blade length, 85mm in total length
- x1 Corneal Scleral Forceps
Straight, 0.3mm, 104mm in total length
- x1 Capsulorhexis Forceps
Curved, round tips, 0.3mm in tip width, 102mm in total length
- x1 Tying Forceps Short angled, platform
Short angled, platform 4.5mm in length, 114mm in total length
- x1 Tying Forceps Straight, platform
Straight, platform 4.5mm in length, 105mm in total length
- x1 Straight Toothed Forceps
Straight toothed forceps, 1x2teeth, 0.12mm, 105mm
- x1 Blade Holder
With spring, 117mm in total length
- x1 Infusion Handpiece of Cataract
Single head of cone, 90mm in total length
- x1 Iris Spatula
1.2 mm, 1.7mm, 122mm in total length
- x1 Cautery
Ball shape tip, 5mm, 120mm in total length
- x1 IOL Fixation Hook
0.2mm cylindrical tip, angled 15degree, 119mm in total length
- x1 IOL Fixation Hook
T type, 0.2mm, 119mm in total length
- x1 Lens Loop
Tip 5mm (width) x 7mm (length) curved loop, 120mm in total length
- x1 Coaxial I/A Cannula
Aperture 0.3mm
- x1 Posterior capsule polisher
Short angled, Aperture 0.3mm
- x1 Iris Spatula
Flush type, Aperture 0.3mm
- x1 Eye Speculum
Wire speculum, stainless 14mm in blade length, 43mm in total length

TG-REF:1371

Titanium Cataract Set instruments

Description



- Corneal Scissors
- Cataract Scissors Membrane Curved tips
- Micro-needle Holder Curved
- Vannas Scissors Straight Straight
- Vannas Scissors Straight Curved
- Corneal Scleral Forceps Straight
- Capsulorhexis Forceps Curved, round tips
- Tying Forceps Short angled
- Tying Forceps Straight, platform Straight
- Straight Toothed Forceps Straight toothed forceps
- Blade Holder With spring
- Infusion Handpiece of Cataract Single head of cone
- Iris Spatula
- Cautery Ball shape tip
- IOL Fixation Hook
- IOL Fixation Hook T type
- Lens Loop Tip
- Coaxial I/A Cannula Aperture 0.3mm
- Posterior capsule polisher Short angled
- Iris Spatula Flush type
- Eye Speculum Wire speculum

TG-REF:1372



TAHIR GROUP OF INDUSTRIES



+92-300-6669737



TAHIR GROUP OF INDUSTRIES



TGIND.COM



TAHIR GROUP OF INDUSTRIES



info@tgind.com



AK-HW-01 Round Sterilizer Drum

18/10 Stainless Steel Domed Top and bottom with sliding removeable band and drop down Claps hinged lid

Sizes,

- 125 X 80
- 125 X 100
- 125 X 125
- 150 X 80 ,
- 150 X 100,
- 150 X 150
- 190 X 125,
- 190 X 145,
- 190 X 165

TG-REF:1373

AK-HW-02 Round Sterilizer Drum with Filter

18/10 Stainless Steel. Perforated Hinged lid and bottom with interchangeable filters

Sizes,

- | | |
|------------|------------|
| 125 X 80 | 240 X 145 |
| 125 X 100 | 240 X 190 |
| 125 X 125 | 240 X 240 |
| 150 X 80 , | 340 X 145 |
| 150 X 100, | 340 X 165, |
| 150 X 150 | 340 X 340 |
| 190 X 125, | 390 X 340 |
| 190 X 145, | 390 X 390 |
| 190 X 165 | 390 X 490 |

TG-REF:1374





Instruments Box with Lid

18/10 Stainless Steel with Design Cover

Sizes,

- 170 X 70 X 30
- 180 X 80 X 40
- 180 X 60 X 40
- 180 X 90 X 40
- 200 X 100 X 40
- 200 X 100 X 50
- 220 X 120 X 50
- 300 X 180 X 50
- 300 X 200 X 50

TG-REF:1375

Instruments Box with Lid with knob

18/10 Stainless Steel with Knob

Sizes,

- 165 X 90 X 35
- 200 X 100 X 50
- 230 X 130 X 50
- 300 X 180 X 50
- 300 X 200 X 50

TG-REF:1376



TAHIR GROUP OF INDUSTRIES



+92-300-6669737



TAHIR GROUP OF INDUSTRIES



TGIND.COM



TAHIR GROUP OF INDUSTRIES



info@tgind.com



Instruments Boiler

Made with 18/10 Stainless Steel
Pressed without welding

Sizes,

200 X 110 X 50
240 X 160 X 50
300 X 180 X 65
360 X 210 X 70
400 X 230 X 80

TG-REF:1377



Electric Sterilizer

S/S 304 Grade with Tray Lifting &
Thermostat Jointed

TG-REF:1378

Instruments Boiler

Made with 18/10 Stainless Steel
Body lid and perforated. Hooks to
lift the internal tray. Closed with
joint handles

Sizes,

180 X 80 X 40
200 X 100 X 60
220 X 120 X 60
250 X 120 X 60
300 X 125 X 60
400 X 160 X 75

TG-REF:1379



TAHIR GROUP OF INDUSTRIES



+92-300-6669737



TAHIR GROUP OF INDUSTRIES



TGIND.COM



TAHIR GROUP OF INDUSTRIES



info@tgind.com



Instruments Trays with Out Cover

Made with 18/10 Stainless Steel
Pressed without welding

Sizes,

- 200 X 150 X 25
- 260 X 180 X 30
- 300 X 220 X 30
- 350 X 250 X 40
- 220 X 200 X 50
- 280 X 200 X 50
- 370 X 270 X 70
- 460 X 360 X 55

TG-REF:1380

Mayo Tray With Stand

Size: (19 1/8" x 12 1/2" x 5/8")

TG-REF:1381



Scaler Trays

Made with 18/10 Stainless Steel
Pressed without welding

Sizes,

190 X 100 X 15

TG-REF:1382



TAHIR GROUP OF INDUSTRIES



+92-300-6669737



TAHIR GROUP OF INDUSTRIES



TGIND.COM



TAHIR GROUP OF INDUSTRIES



info@tgind.com



Kidney Dish with Cover

Made with 18/10 Stainless Steel Pressed without welding.

Sizes,

160mm	100ml
200mm	400ml
250mm	550ml
280mm	1000ml

TG-REF:1383



Kidney Dish

Made with 18/10 Stainless Steel

Sizes,

15cm ,
20cm,
25cm
27.5cm
30cm

TG-REF:1384



Kidney Dish Sallow

Made with 18/10 Stainless Steel

Sizes,

15cm ,
20cm,
25cm
27.5cm
30cm

TG-REF:1385





Dressing Jar

Made with 18/10 Stainless Steel
Pressed without welding

Sizes,

75 X 75mm
100 X 100mm
125 X 125mm
150 X 150mm
180 X 180mm
200 X 200mm
300 X 300mm

TG-REF:1386



Round Bowls with Cover

Made with 18/10 Stainless Steel
Pressed without welding

Sizes,

40mm	30ml
60mm	50ml
80mm	150ml
100mm	250ml
120mm	450ml
200mm	1500ml
250mm	500ml

TG-REF:1387



Irrigator

Made with 18/10 Stainless Steel
Pressed without welding

Sizes,

1000ml
1500ml
2000ml

TG-REF:1388





Sputum Cup

Made with 18/10 Stainless Steel

Sizes,

TG-REF:1389



Measuring Jar

Made with 18/10 Stainless Steel

Sizes,

500ml
1000ml
1500ml
2000ml

TG-REF:1390



Cotton holder

Made with 18/10 Stainless Steel

TG-REF:1391



TAHIR GROUP OF INDUSTRIES



+92-300-6669737



TAHIR GROUP OF INDUSTRIES



TGIND.COM



TAHIR GROUP OF INDUSTRIES



info@tgind.com



Alcohol Plate

Made with 18/10 Stainless Steel
Complete With Burners

Sizes,

with Two Flames

With Three Flames

TG-REF:1392

Alcohol Lamp

Made with 18/10 Stainless Steel
Crome plated Brass Cap

Sizes,

AK-HW-02 50cc

AK-HW-03 100cc

TG-REF:1393



Alcohol Lamp with Flam Control

TG-REF:1394



Alcohol Lamp Standard

TG-REF:1395



Forceps Jar



Made with 18/10 Stainless Steel

Sizes

- 50 X 100
- 50 X 150
- 50 X 175
- 75 X 100
- 75 X 175
- 100 X 175
- 125 X 250

TG-REF:1396

Cotton Container



Made with 18/10 Stainless Steel

Sizes

- 75 X 75
- 100 X 100
- 125 X 125
- 150 X 50
- 180 X 180
- 200 X 200

TG-REF:1397





Bedpan

Made with 18/10 Stainless Steel
TG-REF:1398



Bed Pan

Made with 18/10 Stainless Steel
TG-REF:1399



Bed Pan Sleeper Type with Tube Handle

Made with 18/10 Stainless Steel
TG-REF:1400



Wire Mesh Baskets

Made with Stainles Steel Wire



Sizes,

210 X 145 X 50
240 X 240 X 50
240 X 240 X 70
480 X 240 X 50
540 X 240 X 50
540 X 240 X 90

TG-REF:1401

Round Bedpan with Cover

Made with 18/10 Stainless Steel

TG-REF:1402



TAHIR GROUP OF INDUSTRIES



+92-300-6669737



TAHIR GROUP OF INDUSTRIES



TGIND.COM



TAHIR GROUP OF INDUSTRIES



info@tgind.com

Double Bowl Stand

Bowl Sizes is 32cm Each
Available in Plastic and Stainless Steel Base
TG-REF:1403



DRIP STAND 2 Hooks

TG-REF:1404



Instruments Trolley

with 3 Shelves
TG-REF:1405



DRIP STAND 4 Hooks

TG-REF:1406



Surgical Instruments Box , Mats

Box For Holding Crocodile Forceps

Width x Length x Height

TG-HW-000297 12"X8"X4.5" (300mmX200mmX109mm)

Basket case ultrasonic Cleaning Washing Trays Sterilization by all standard methods Autoclave
Available in customize sizes and colors .
Produced from 1050 Quality H24 Aluminium . 130° to 135° Temperature Sterilize



Ophthalmic Sterilization Tray Box with Silicone Mat

Width x Length x Height

TG-HW-000298 (150mmX120mmX28mm)
TG-HW-000299 (195mmX104mmX27mm)
TG-HW-000300 (260mmX152mmX28mm)

Basket case ultrasonic Cleaning Washing Sterilization Trays use for Microsurgery,
Ophthalmic Instruments Sterilization by all standard methods Autoclave
Available in customize sizes and colors .
Produced from 1050 Quality H24 Aluminium . 130° to 135° Temperature Sterilize



Aluminum Sterilization Box Double Tray With Mat

Width x Length x Height

TG-HW-000301 12 $\frac{3}{4}$ " x 6" x 4" (320 x 150 x 60 mm)
TG-HW-000302 16" x 8" x 4" (400 x 200 x 100 mm)
TG-HW-000303 20" x 8" x 4" (500 x 200 x 100 mm)
TG-HW-000304 20" x 8 $\frac{1}{4}$ " x 4 $\frac{3}{4}$ " (500 x 210 x 120 mm)

Autoclavable Sterile Tray Box used to hold Orthopedic, Microsurgery, Cardiac surgery
Ophthalmic Surgery Instruments Available in customize sizes and colors .
Produced from 1050 Quality H24 Aluminium . 130° to 135° Temperature Sterilize

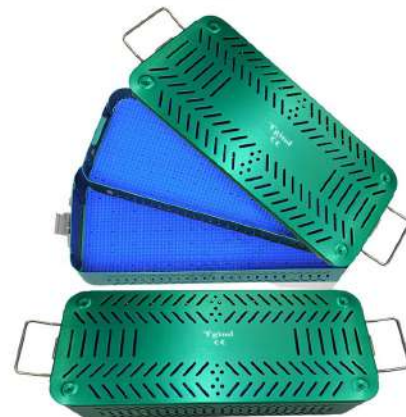

Standard Tray, Deep base, Insert Tray, Lid & 2 Silicone Mats

Width x Length x Height

TG-HW-000305 6.0 X 10.0 X 1.5"

These features make PST Plastic Sterilization Trays better for sterilizing your surgical instruments.
Flexibility of layout. Either finger-tip mats or special, "plug-in" inserts for individual instruments.
Unique, "grid" system in all bases, trays and lids, making it easy to install the mat or insert required to protect your instruments properly.
Stackable trays. Integral feet in bases and corner ridges on lids allow for easier handling in autoclaves and storage.
All bases have pebble-type surface to keep mats from sticking.
Dimensions of each tray are designed to accommodate a variety of instrument sizes and shapes.
Sterilizable by all standard methods of sterilization.

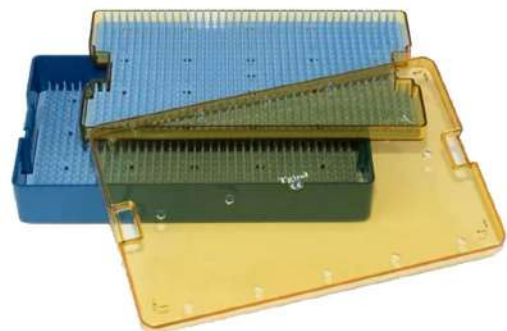

Surgical Instruments Box , Mats

Instruments Sterilization Tray Box

Width x Length x Height

TG-HW-000252	6¾" x 2¾" x 1¼"	(170 x 70 x 30 mm)
TG-HW-000253	7" x 3¼" x 1¼"	(180 x 80 x 40 mm)
TG-HW-000254	7" x 3½" x 1¾"	(180 x 90 x 40 mm)
TG-HW-000255	8" x 4" x 1¾"	(200 x 100 x 40 mm)
TG-HW-000256	8" x 4" x 2¾"	(200 x 100 x 60 mm)
TG-HW-000257	8½" x 4¾" x 2¾"	(220 x 120 x 60 mm)
TG-HW-000258	10" x 8" x 2¾"	(250 x 120 x 60 mm)
TG-HW-000259	12" x 8" x 2"	(300 x 200 x 50 mm)
TG-HW-000260	12¾" x 6" x 4"	(320 x 150 x 60 mm)
TG-HW-000261	16" x 8" x 4"	(400 x 200 x 100 mm)
TG-HW-000262	20" x 8" x 4"	(500 x 200 x 100 mm)
TG-HW-000263	20" x 8¼" x 4¾"	(500 x 210 x 120 mm)

Autoclavable Sterile Tray Box used to hold Orthopedic, Microsurgery, Cardiac surgery Ophthalmic Surgery Instruments Available in customize sizes and colors .

Produced from 1050 Quality H24 Aluminium . 130° to 135° Temperature Sterilize



Width x Length x Height

TG-HW-000264	6¾" x 2¾" x 1¼"	(170 x 70 x 30 mm)
TG-HW-000265	7" x 3¼" x 1¼"	(180 x 80 x 40 mm)
TG-HW-000266	7" x 3½" x 1¾"	(180 x 90 x 40 mm)
TG-HW-000267	8" x 4" x 1¾"	(200 x 100 x 40 mm)
TG-HW-000268	8" x 4" x 2¾"	(200 x 100 x 60 mm)
TG-HW-000269	8½" x 4¾" x 2¾"	(220 x 120 x 60 mm)
TG-HW-000270	10" x 8" x 2¾"	(250 x 120 x 60 mm)
TG-HW-000271	12" x 8" x 2"	(300 x 200 x 50 mm)
TG-HW-000272	12¾" x 6" x 4"	(320 x 150 x 60 mm)
TG-HW-000273	16" x 8" x 4"	(400 x 200 x 100 mm)
TG-HW-000274	20" x 8" x 4"	(500 x 200 x 100 mm)
TG-HW-000275	20" x 8¼" x 4¾"	(500 x 210 x 120 mm)

Autoclavable Sterile Tray Box used to hold Orthopedic, Microsurgery, Cardiac surgery Ophthalmic Surgery Instruments Available in customize sizes and colors .

Produced from 1050 Quality H24 Aluminium . 130° to 135° Temperature Sterilize



Instruments Sterilization Container Box

Width x Length x Height

TG-HW-000276	6¾" x 2¾" x 1¼"	(170 x 70 x 30 mm)
TG-HW-000277	7" x 3¼" x 1¼"	(180 x 80 x 40 mm)
TG-HW-000278	7" x 3½" x 1¾"	(180 x 90 x 40 mm)
TG-HW-000279	8" x 4" x 1¾"	(200 x 100 x 40 mm)
TG-HW-000280	8" x 4" x 2¾"	(200 x 100 x 60 mm)
TG-HW-000281	8½" x 4¾" x 2¾"	(220 x 120 x 60 mm)
TG-HW-000282	10" x 8" x 2¾"	(250 x 120 x 60 mm)
TG-HW-000283	12" x 8" x 2"	(300 x 200 x 50 mm)
TG-HW-000284	12¾" x 6" x 4"	(320 x 150 x 60 mm)
TG-HW-000285	16" x 8" x 4"	(400 x 200 x 100 mm)
TG-HW-000286	20" x 8" x 4"	(500 x 200 x 100 mm)
TG-HW-000287	20" x 8¼" x 4¾"	(500 x 210 x 120 mm)

Autoclavable Sterile Tray Box used to hold Orthopedic, Microsurgery, Cardiac surgery Ophthalmic Surgery Instruments Available in customize sizes and colors .

Produced from 1050 Quality H24 Aluminium . 130° to 135° Temperature Sterilize



Instruments Sterilization Container Box

Width x Length x Height

TG-HW-000288	6¾" x 2¾" x 1¼"	(170 x 70 x 30 mm)
TG-HW-000289	7" x 3¼" x 1¼"	(180 x 80 x 40 mm)
TG-HW-000290	7" x 3½" x 1¾"	(180 x 90 x 40 mm)
TG-HW-000291	8" x 4" x 1¾"	(200 x 100 x 40 mm)
TG-HW-000292	8" x 4" x 2¾"	(200 x 100 x 60 mm)
TG-HW-000293	8½" x 4¾" x 2¾"	(220 x 120 x 60 mm)
TG-HW-000294	10" x 8" x 2¾"	(250 x 120 x 60 mm)
TG-HW-000295	12" x 8" x 2"	(300 x 200 x 50 mm)
TG-HW-000296	12¾" x 6" x 4"	(320 x 150 x 60 mm)

Autoclavable Sterile Tray Box used to hold Orthopedic, Microsurgery, Cardiac surgery Ophthalmic Surgery Instruments Available in customize sizes and colors .

Produced from 1050 Quality H24 Aluminium . 130° to 135° Temperature Sterilize





TAHIR GROUP OF INDUSTRIES

Manufacture & Exporters of Surgical Instruments

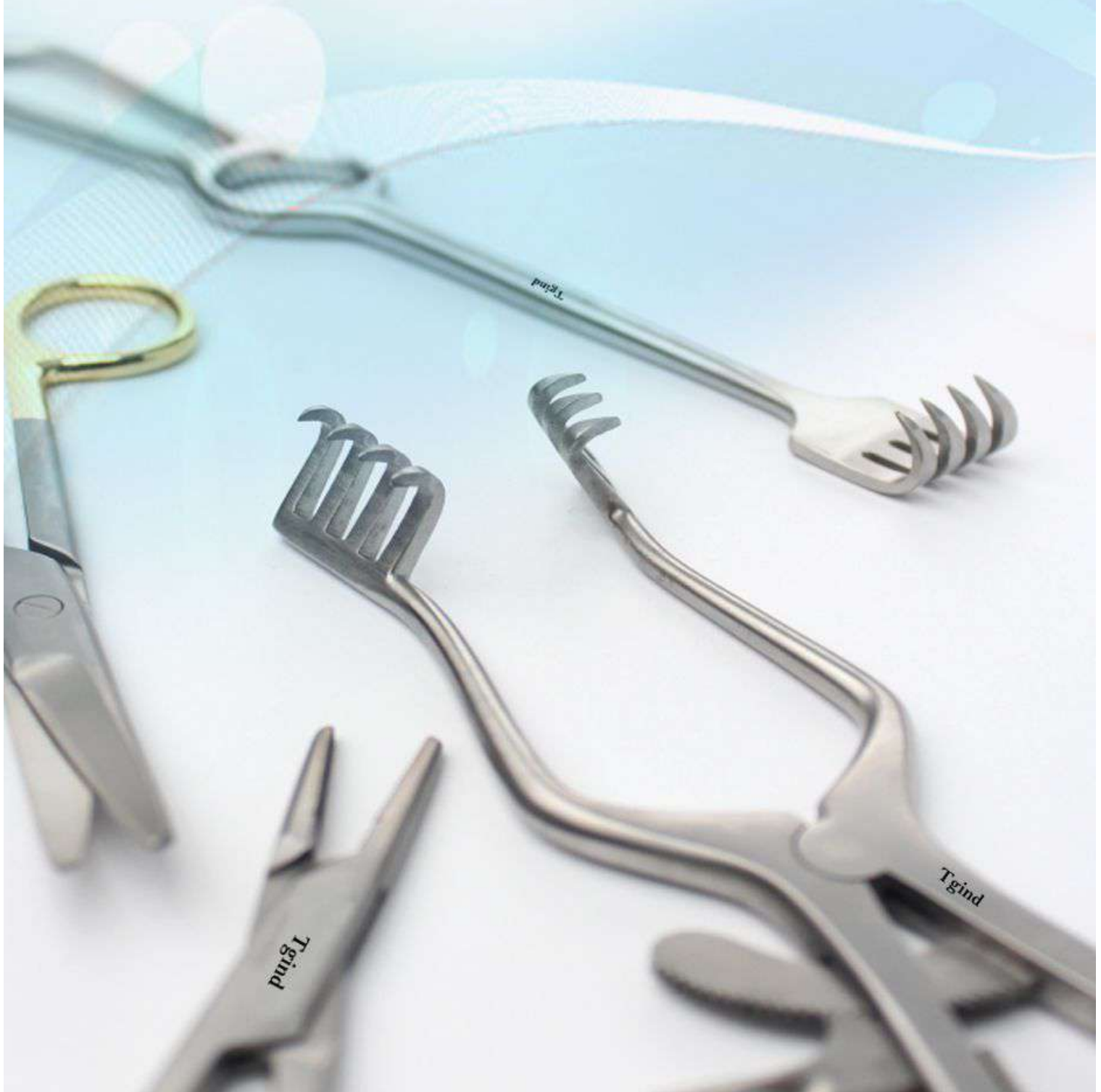

Tell Off: +92-52-3257151
Fax: +92-52-3257151
Mob: +92-300-666-9737

Adress:
Dubai Islamic Bank Street Shahab Pura
Road Opposite S.I.E 51310 sialkot

E-Mail: info@tgind.com/
tgindsale@gmail.com
Website: www.tgind.com



Medicines &
Healthcare products
Regulatory Agency

