



Tahir Group Of Industries

TGIND provide all kind of gynaecology instruments with high quality material

CERTIFICATE OF COMPLIANCE

This is to certify, that the hereunder described items of Medical Devices Directive 93/42/EEC as amended by Directive 2007/42/EC have proven their conformity to the Safety and Health requirements.

Manufactured by: **TAHIR GROUP OF INDUSTRIES**

Address: Dubai Islamic Bank Street Opposite S.I.E, Shahab Pura Road, Shahabpura, Sialkot-51310, Pakistan.

Product: **Surgical, Dental, Electrosurgical, Orthopedic, Laparoscopic, Diagnostic, Veterinary and Beauty Instruments, Mackintosh Rubber Sheet & Medical Silicone & Rubber Products.**

Classification: **Class I non-sterile, non-powered and non-measuring devices (accordingly, to the Manufacturer's declaration)**

The product liability rests with the manufacturer in accordance with applicable regulations and standards, after fulfilling the relevant EU legislation requirements and withdrawing an EC declaration of conformity as per Annexure-VII, module A of the product, you are therefore licensed to CE mark the product(s) listed above in accordance with Article 17 of the Medical Device Directive. The manufacturer is responsible for the CE Marking process and is not to be exempted from carrying out all necessary compliance activities.

This certificate shall not be reproduced except in full and remains the property of CNC Services, which must be returned on request. The holder must inform CNC Services of any substantial changes that occurred in the product or process to examine whether this certificate remains valid.



For CNC Services

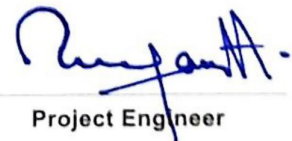

Project Engineer

Date of Issue: 24th March 2023
Date of Expiry: 23rd March 2024
Certificate Number: EC/5231/23

CERTIFICATE

No. 920137



This is to certify the Quality Management System for Medical Devices of



www.tgind.com

Tahir Group of Industries

Dubai Islamic Bank Street Opposite S.I.E, Shahab Pura Road, Shahabpura,
Sialkot, Punjab 51310
Pakistan

has been assessed and found to be in compliance with the Standard

ISO 13485:2016

applicable to

**Manufacturer and Exporter of Surgical, Dental,
Electrosurgical, Orthopedic, Laparoscopic, Diagnostic,
Beauty Instruments.**

The certificate has been issued under No. 920137 for the registration period from
29 March 2023 to 28 March 2026.

The first certificate date of issue is 29 March 2023.

Approved by

Printed by



validity code **48469BAF-E84**

Check the validity of this certificate using this code at www.ll-c.info

LL-C (Certification) Czech Republic a.s. | Pobřežní 620/3, 186 00 Praha 8

CERTIFICATE

No. 920137



This is to certify the Quality Management System of



www.tgind.com

Tahir Group of Industries

Dubai Islamic Bank Street Opposite S.I.E, Shahab Pura Road, Shahabpura,
Sialkot, Punjab 51310
Pakistan

has been assessed and found to be in compliance with the Standard

ISO 9001:2015

applicable to

Manufacturer and Exporter of Surgical, Dental, Electrosurgical, Orthopedic, Laparoscopic, Diagnostic, Veterinary and Beauty Instruments, Mackintosh Rubber Sheet Reusable & Medical Silicone & Rubber Products Reusable.

The certificate has been issued under No. 920137 for the registration period from 29 March 2023 to 28 March 2026.

The first certificate date of issue is 29 March 2023.

Approved by

Printed by



validity code **5E25D38F-F2A**

Check the validity of this certificate using this code at www.ll-c.info

LL-C (Certification) Czech Republic a.s. | Pobřežní 620/3, 186 00 Praha 8

Laparoscopy Surgical Instruments

Laparoscopic Storz Type Grasper With Handle

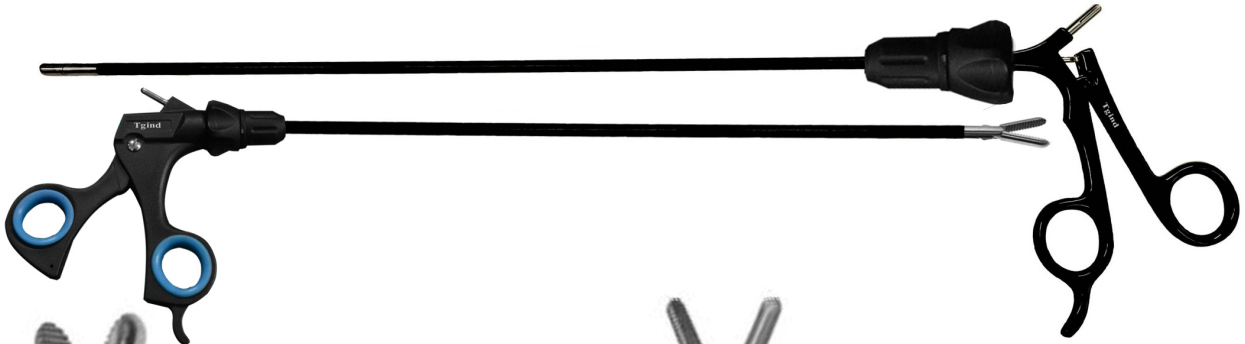

Size:	5MM Ø, STANDARD GRASPER/ DISSECTOR WITH SPOON	
33cm	TG-REF:00664	TG-REF:00665
36cm	TG-REF:00666	TG-REF:00667
45cm	TG-REF:00668	TG-REF:00669
24cm	TG-REF:00670	TG-REF:00671



Size:	5MM Ø, MICRO REDDICKOLSEN GRASPER/DISSECTOR	
33cm	TG-REF:00688	TG-REF:00689
36cm	TG-REF:00690	TG-REF:00691
45cm	TG-REF:00692	TG-REF:00693
24cm	TG-REF:00694	TG-REF:00695



Size:	5MM Ø, STANDARD GRASPER/ DISSECTOR	
33cm	TG-REF:00672	TG-REF:00673
36cm	TG-REF:00674	TG-REF:00675
45cm	TG-REF:00676	TG-REF:00677
24cm	TG-REF:00678	TG-REF:00679



Size:	5MM Ø, STANDARD GRASPER/DISSECTOR W/SPOON, LONG 20 MM JAW	
33cm	TG-REF:00696	TG-REF:00697
36cm	TG-REF:00698	TG-REF:00699
45cm	TG-REF:00700	TG-REF:00701
24cm	TG-REF:006702	TG-REF:00703



Size:	5MM Ø, TAPERED DOLPHINNOSE GRASPER/DISSECTOR	
33cm	TG-REF:00680	TG-REF:00681
36cm	TG-REF:00682	TG-REF:00683
45cm	TG-REF:00684	TG-REF:00685
24cm	TG-REF:00686	TG-REF:00687



Size:	5MM Ø, BULLET-NOSE GRASPER /DISSECTOR WITH SPOON	
33cm	TG-REF:00704	TG-REF:00705
36cm	TG-REF:00706	TG-REF:00707
45cm	TG-REF:00708	TG-REF:00709
24cm	TG-REF:00710	TG-REF:00711

Style A:

Style B:

Style C:



Type 3:
Non-Insulated
Ratchet /
Ratchet Defeating



Type 2:
Non-Insulated
Stainless Steel



Type 1:
Insulated Stainless
Steel w/ RF Post



Size:	5MM Ø, TAPERED DOLPHINNOSE GRASPER/DISSECTOR W/ SPOON	
33cm	TG-REF:00712	TG-REF:00713
36cm	TG-REF:00714	TG-REF:00715
45cm	TG-REF:00716	TG-REF:00717
24cm	TG-REF:00718	TG-REF:00719

Laparoscopic Grasper & Dissector With Handle

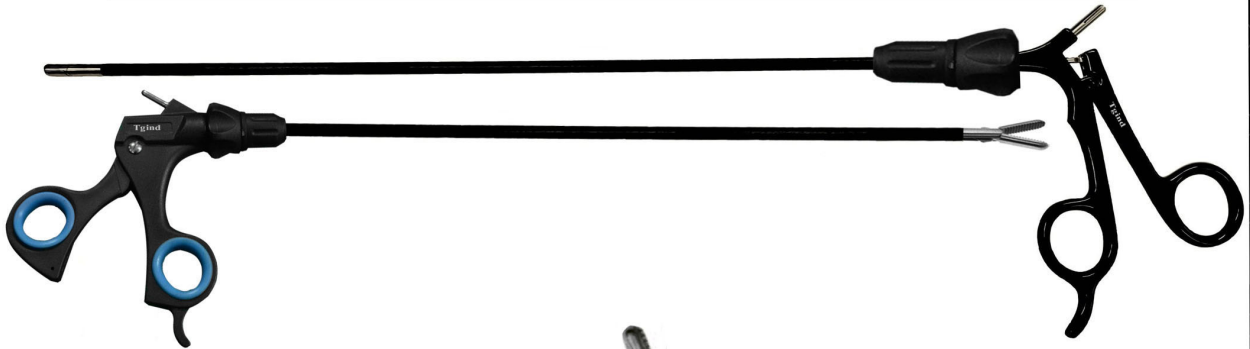

Size:	5MM Ø, TAPERED MARYLAND GRASPER/DISSECTOR, 18MM LENGTH TIP	
33cm	TG-REF:721	TG-REF:725
36cm	TG-REF:722	TG-REF:726
45cm	TG-REF:723	TG-REF:727
24cm	TG-REF:724	TG-REF:728



Size:	5MM Ø, MARYLAND GRASPER/DISSECTOR, 18MM LENGTH TIP	
33cm	TG-REF:745	TG-REF:777
36cm	TG-REF:746	TG-REF:778
45cm	TG-REF:775	TG-REF:779
24cm	TG-REF:776	TG-REF:780



Size:	5MM Ø, MIXER GRASPER/DISSECTOR RIGHT ANGLE (LONG)	
33cm	TG-REF:729	TG-REF:733
36cm	TG-REF:730	TG-REF:734
45cm	TG-REF:731	TG-REF:735
24cm	TG-REF:732	TG-REF:736



Size:	5MM Ø, SHORT MARYLAND GRASPER/DISSECTOR, 15MM LENGTH TIP	
33cm	TG-REF:781	TG-REF:785
36cm	TG-REF:782	TG-REF:786
45cm	TG-REF:783	TG-REF:787
24cm	TG-REF:784	TG-REF:788



Size:	5MM Ø, MIXER GRASPER/DISSECTOR 45 DEGREE ANGLE	
33cm	TG-REF:737	TG-REF:741
36cm	TG-REF:738	TG-REF:742
45cm	TG-REF:739	TG-REF:743
24cm	TG-REF:740	TG-REF:744



Size:	5MM Ø, MIXER GRASPER/DISSECTOR, SHORT RIGHT ANGLE	
33cm	TG-REF:789	TG-REF:793
36cm	TG-REF:790	TG-REF:794
45cm	TG-REF:791	TG-REF:795
24cm	TG-REF:792	TG-REF:796

Style A:

Style B:

Style C:



Type 3:
Non-Insulated
Ratchet /
Ratchet Defeating

Type 2:
Non-Insulated
Stainless Steel

Type 1:
Insulated Stainless
Steel w/ RF Post

Size:	5MM Ø, DUCKBILL GRASPER/DISSECTOR	
33cm	TG-REF:797	TG-REF:801
36cm	TG-REF:798	TG-REF:803
45cm	TG-REF:799	TG-REF:804
24cm	TG-REF:800	TG-REF:805

Laparoscopic Grasper & Dissector With Handle

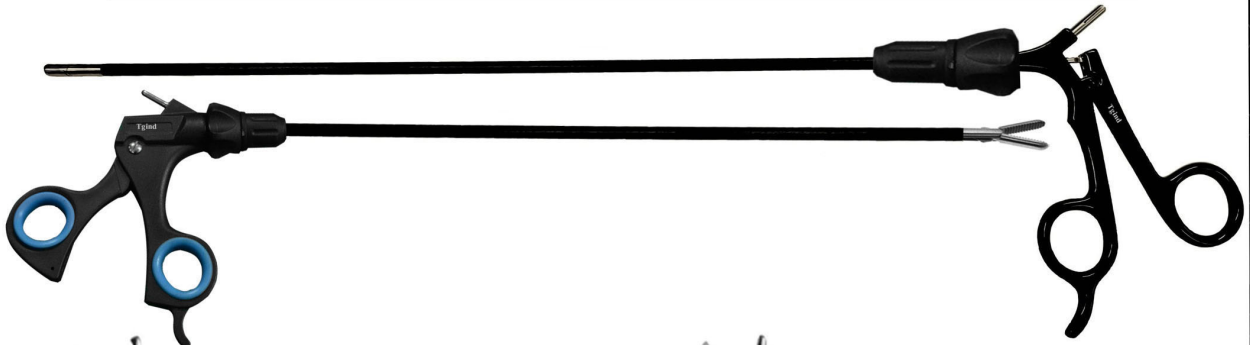

Size:	5MM Ø, KELLY GRASPER/ DISSECTOR	
33cm	TG-REF:805	TG-REF:809
36cm	TG-REF:806	TG-REF:810
45cm	TG-REF:807	TG-REF:811
24cm	TG-REF:808	TG-REF:812



Size:	5MM Ø, NEEDLE-NOSE GRASPER/DISSECTOR	
33cm	TG-REF:829	TG-REF:833
36cm	TG-REF:830	TG-REF:834
45cm	TG-REF:831	TG-REF:835
24cm	TG-REF:832	TG-REF:836



Size:	5MM Ø, PETELIN DISSECTOR, 60 DEG. ANGLE LEFT, SINGLE-ACTION	
33cm	TG-REF:813	TG-REF:817
36cm	TG-REF:814	TG-REF:818
45cm	TG-REF:815	TG-REF:819
24cm	TG-REF:816	TG-REF:820



Size:	5MM Ø, LONG REACH, RIGHT ANGLE DISSECTOR, DBL ACTION (REQUIRES LARGERCANNULA)	
33cm	TG-REF:837	TG-REF:841
36cm	TG-REF:838	TG-REF:842
45cm	TG-REF:839	TG-REF:843
24cm	TG-REF:840	TG-REF:844



Size:	5MM Ø, MICRO GRASPER/ DISSECTOR, FENESTRATED	
33cm	TG-REF:821	TG-REF:825
36cm	TG-REF:822	TG-REF:826
45cm	TG-REF:823	TG-REF:827
24cm	TG-REF:824	TG-REF:828



Size:	5MM Ø, PETELIN DISSECTOR, 30DEG. ANGLE LEFT, SINGLE ACTION	
33cm	TG-REF:845	TG-REF:849
36cm	TG-REF:846	TG-REF:850
45cm	TG-REF:847	TG-REF:851
24cm	TG-REF:848	TG-REF:852

Style A:

Style B:

Style C:



Type 3:
Non-Insulated
Ratchet /
Ratchet Defeating

Type 2:
Non-Insulated
Stainless Steel

Type 1:
Insulated Stainless
Steel w/ RF Post

Size:	5MM Ø, COBRA GRASPER, DOUBLE-ACTION	
33cm	TG-REF:853	TG-REF:857
36cm	TG-REF:854	TG-REF:858
45cm	TG-REF:855	TG-REF:859
24cm	TG-REF:856	TG-REF:900

Laparoscopic Grasper & Dissector With Handle

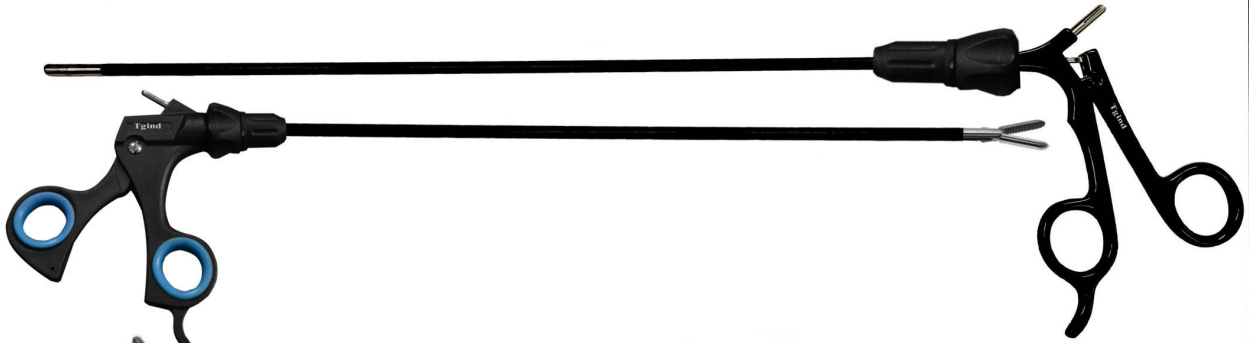

Size:	5MM Ø, BABCOCK GRASPER, AXIS STYLE, FENESTRATED TIP	
33cm	TG-REF:901	TG-REF:905
36cm	TG-REF:902	TG-REF:906
45cm	TG-REF:903	TG-REF:907
24cm	TG-REF:904	TG-REF:908



Size:	5MM Ø, BABCOCK GRASPER, FENESTRATED TIP	
33cm	TG-REF:926	TG-REF:833
36cm	TG-REF:927	TG-REF:834
45cm	TG-REF:928	TG-REF:835
24cm	TG-REF:929	TG-REF:836



Size:	5MM Ø, ALLIS GRASPER, SHORT VERSION, SINGLE ACTION	
33cm	TG-REF:910	TG-REF:914
36cm	TG-REF:911	TG-REF:915
45cm	TG-REF:912	TG-REF:916
24cm	TG-REF:913	TG-REF:917



Size:	5MM Ø, BABCOCK GRASPER SHORT: DELICATE APPLICATION	
33cm	TG-REF:930	TG-REF:841
36cm	TG-REF:931	TG-REF:842
45cm	TG-REF:932	TG-REF:843
24cm	TG-REF:933	TG-REF:844



Size:	5MM Ø, ATRAUMATIC ALLIS GRASPER, SHORT VERSION, SERRATED W/ DOUBLE ROW OF TEETH, DOUBLE-ACTION	
33cm	TG-REF:918	TG-REF:922
36cm	TG-REF:919	TG-REF:923
45cm	TG-REF:920	TG-REF:924
24cm	TG-REF:921	TG-REF:925



Size:	5MM Ø, ALLIS GRASPER, SHORT VERSION, 3 X 4 TEETH, SERRATED, DOUBLE ACTION	
33cm	TG-REF:934	TG-REF:849
36cm	TG-REF:935	TG-REF:850
45cm	TG-REF:936	TG-REF:851
24cm	TG-REF:937	TG-REF:852

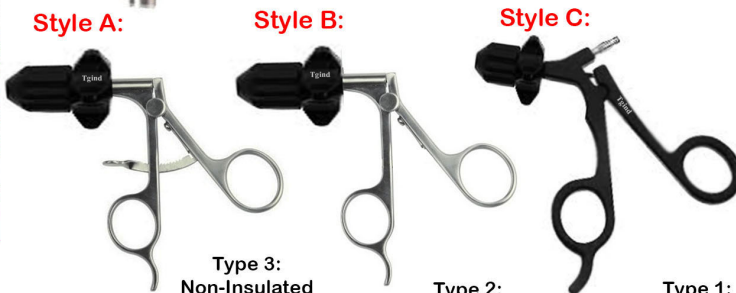

Style A:
Type 3:
Non-Insulated
Ratchet /
Ratchet Defeating

Style B:
Type 2:
Non-Insulated
Stainless Steel

Style C:
Type 1:
Insulated Stainless
Steel w/ RF Post

Size:	5MM Ø, ATRAUMATIC ALLIS GRASPER, LONG VERSION, SERRATED W/ DOUBLE ROW OF TEETH, DOUBLE-ACTION	
33cm	TG-REF:938	TG-REF:943
36cm	TG-REF:939	TG-REF:944
45cm	TG-REF:941	TG-REF:945
24cm	TG-REF:942	TG-REF:946

Laparoscopic Grasper & Dissector With Handle

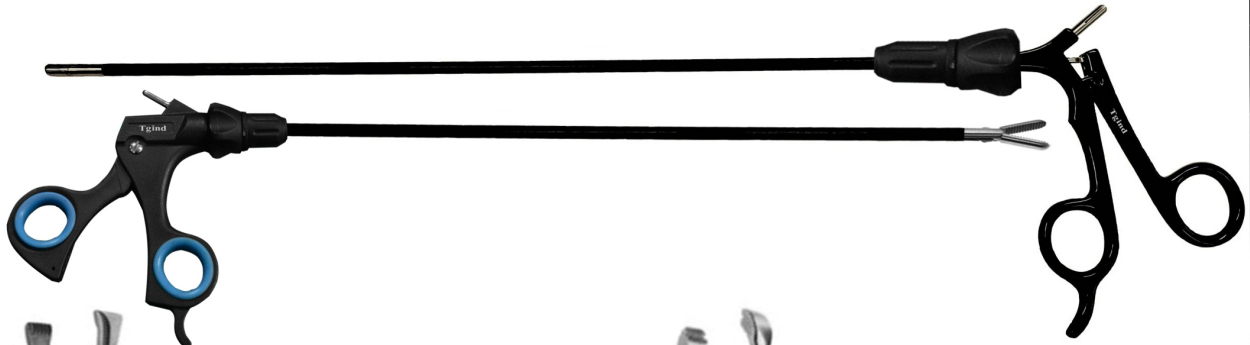

Size:	5MM Ø, ALLIS GRASPER, STANDARD VERSION	
33cm	TG-REF:947	TG-REF:951
36cm	TG-REF:948	TG-REF:952
45cm	TG-REF:949	TG-REF:953
24cm	TG-REF:950	TG-REF:954



Size:	5MM Ø, ALLIS GRASPER, MEDIUM VERSION, (WECK STYLE)	
33cm	TG-REF:963	TG-REF:867
36cm	TG-REF:964	TG-REF:868
45cm	TG-REF:965	TG-REF:869
24cm	TG-REF:966	TG-REF:870



Size:	5MM Ø, DEBAKEY GRASPER, 20 MM JAW LENGTH	
33cm	TG-REF:955	TG-REF:959
36cm	TG-REF:956	TG-REF:960
45cm	TG-REF:957	TG-REF:961
24cm	TG-REF:958	TG-REF:962



Size:	5MM Ø, TC ALLIS, STANDARD VERSION	
33cm	TG-REF:971	TG-REF:875
36cm	TG-REF:972	TG-REF:876
45cm	TG-REF:973	TG-REF:877
24cm	TG-REF:974	TG-REF:878



Size:	5MM Ø, HUNTER/ FENESTRATED DEBAKEY GRASPER, 20 MM JAW LENGTH	
33cm	TG-REF:918	TG-REF:922
36cm	TG-REF:919	TG-REF:923
45cm	TG-REF:920	TG-REF:924
24cm	TG-REF:921	TG-REF:925



Size:	5MM Ø, DEBAKEY GRASPER, 40 MM JAW LENGTH	
33cm	TG-REF:979	TG-REF:883
36cm	TG-REF:980	TG-REF:884
45cm	TG-REF:981	TG-REF:885
24cm	TG-REF:982	TG-REF:886

Style A:

Style B:

Style C:



Type 3:
Non-Insulated
Ratchet /
Ratchet Defeating



Type 2:
Non-Insulated
Stainless Steel



Type 1:
Insulated Stainless
Steel w/ RF Post



Size:	5MM Ø, HUNTER/ FENESTRATED DEBAKEY GRASPER, 40 MM JAW LENGTH	
33cm	TG-REF:987	TG-REF:991
36cm	TG-REF:988	TG-REF:992
45cm	TG-REF:989	TG-REF:993
24cm	TG-REF:990	TG-REF:994

Laparoscopic Grasper & Dissector With Handle

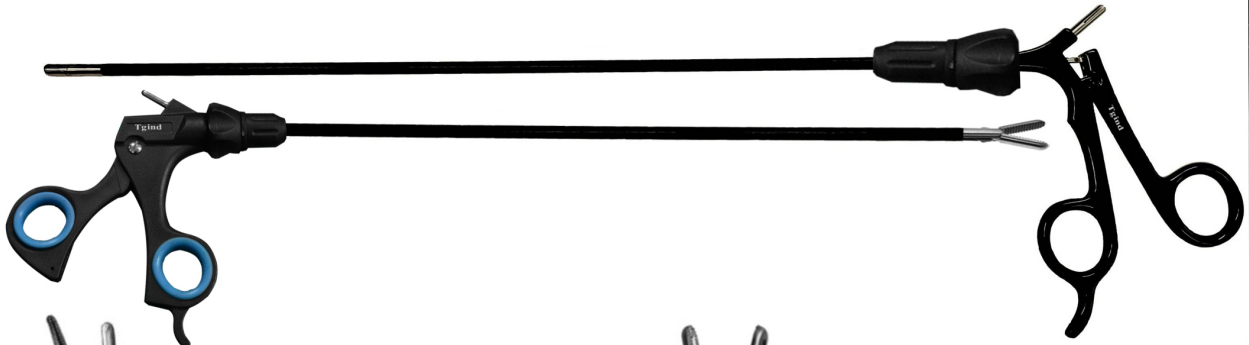

Size:	5MM Ø, DEBAKEY CURVED GRASPER, w/ ATRAUMATIC TEETH, DOUBLE-ACTION	
33cm	TG-REF:995	TG-REF:999
36cm	TG-REF:996	TG-REF:1001
45cm	TG-REF:997	TG-REF:1002
24cm	TG-REF:998	TG-REF:1003



Size:	5MM Ø, HUNTER/FENESTRATED DEBAKEYGRASPER, 60 MM JAW LENGTH	
33cm	TG-REF:1019	TG-REF:1023
36cm	TG-REF:1020	TG-REF:1024
45cm	TG-REF:1021	TG-REF:1025
24cm	TG-REF:1022	TG-REF:1026



Size:	5MM Ø, ATRAUMATIC GRASPER, CROSS SERRATED	
33cm	TG-REF:1004	TG-REF:1007
36cm	TG-REF:1004	TG-REF:1008
45cm	TG-REF:1005	TG-REF:1009
24cm	TG-REF:1006	TG-REF:1010



Size:	5MM Ø, GLASSMAN ATRAUMATIC GRASPER	
33cm	TG-REF:1027	TG-REF:1030
36cm	TG-REF:1028	TG-REF:1031
45cm	TG-REF:1029	TG-REF:1032
24cm	TG-REF:1029	TG-REF:1033



Size:	5MM Ø, "WINER" STYLE FUNDUS MAXI GRASPER	
33cm	TG-REF:1011	TG-REF:1015
36cm	TG-REF:1012	TG-REF:1016
45cm	TG-REF:1013	TG-REF:1017
24cm	TG-REF:1014	TG-REF:1018



Size:	5MM Ø, DOUBLE CUP FUNDUS MAXI GRASPER	
33cm	TG-REF:1034	TG-REF:1038
36cm	TG-REF:1035	TG-REF:1039
45cm	TG-REF:1036	TG-REF:1040
24cm	TG-REF:1037	TG-REF:1041

Style A:

Style B:

Style C:



Type 3:
Non-Insulated
Ratchet /
Ratchet Defeating

Type 2:
Non-Insulated
Stainless Steel

Type 1:
Insulated Stainless
Steel w/ RF Post

Size:	5MM Ø, "MCKERNAN" STYLE FUNDUS MAXI GRASPER	
33cm	TG-REF:1042	TG-REF:1046
36cm	TG-REF:1043	TG-REF:1047
45cm	TG-REF:1044	TG-REF:1048
24cm	TG-REF:1045	TG-REF:1049

Laparoscopic Grasper & Dissector With Handle

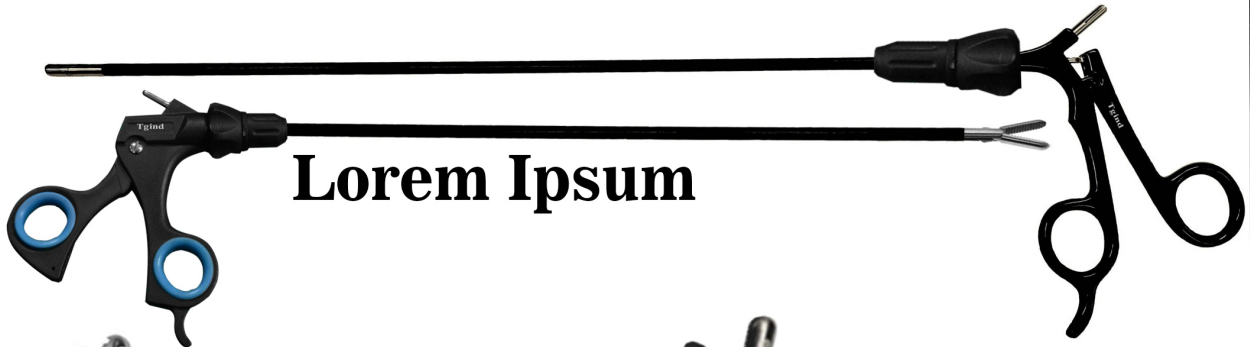

Lorem Ipsum



Size:	5MM Ø, ENDO CLINCH FENESTRATED GRASPER	
33cm	TG-REF:1050	TG-REF:1054
36cm	TG-REF:1051	TG-REF:1055
45cm	TG-REF:1052	TG-REF:1056
24cm	TG-REF:1053	TG-REF:1057



Size:	5MM Ø, DOUBLE CUP FENESTRATED FUNDUS MAXI GRASPER	
33cm	TG-REF:1074	TG-REF:1078
36cm	TG-REF:1075	TG-REF:1079
45cm	TG-REF:1076	TG-REF:1080
24cm	TG-REF:1077	TG-REF:1081



Size:	5MM Ø, ALLIGATOR GRASPER, 10MM JAW, RETRO FACING TEETH DBL-ACTION	
33cm	TG-REF:1058	TG-REF:1062
36cm	TG-REF:1059	TG-REF:1063
45cm	TG-REF:1060	TG-REF:1064
24cm	TG-REF:1061	TG-REF:1065



Size:	5MM Ø, RETRO FACING RAT-TOOTH GRASPER w/ ATRAUMATIC CUP	
33cm	TG-REF:1082	TG-REF:1086
36cm	TG-REF:1083	TG-REF:1087
45cm	TG-REF:1084	TG-REF:1088
24cm	TG-REF:1085	TG-REF:1089



Size:	5MM Ø, ALLIGATOR GRASPER, 20MM JAW, RETRO FACING TEETH, SINGLE-ACTION	
33cm	TG-REF:1066	TG-REF:1070
36cm	TG-REF:1067	TG-REF:1071
45cm	TG-REF:1068	TG-REF:1072
24cm	TG-REF:1069	TG-REF:1073



Size:	5MM Ø, CUP SHAPED GRASPER WITH RETROFACING TEETH, DBL-ACTION	
33cm	TG-REF:1090	TG-REF:1094
36cm	TG-REF:1091	TG-REF:1095
45cm	TG-REF:1092	TG-REF:1096
24cm	TG-REF:1093	TG-REF:1097

Style A:

Style B:

Style C:



Type 3:
Non-Insulated
Ratchet /
Ratchet Defeating



Type 2:
Non-Insulated
Stainless Steel



Type 1:
Insulated Stainless
Steel w/ RF Post



Size:	5MM Ø, CUP SHAPED GRASPER WITH RETROFACING TEETH, DBL-ACTION	
33cm	TG-REF:1098	TG-REF:1102
36cm	TG-REF:1099	TG-REF:1103
45cm	TG-REF:1100	TG-REF:1104
24cm	TG-REF:1101	TG-REF:1105

Laparoscopic Grasper & Dissector With Handle

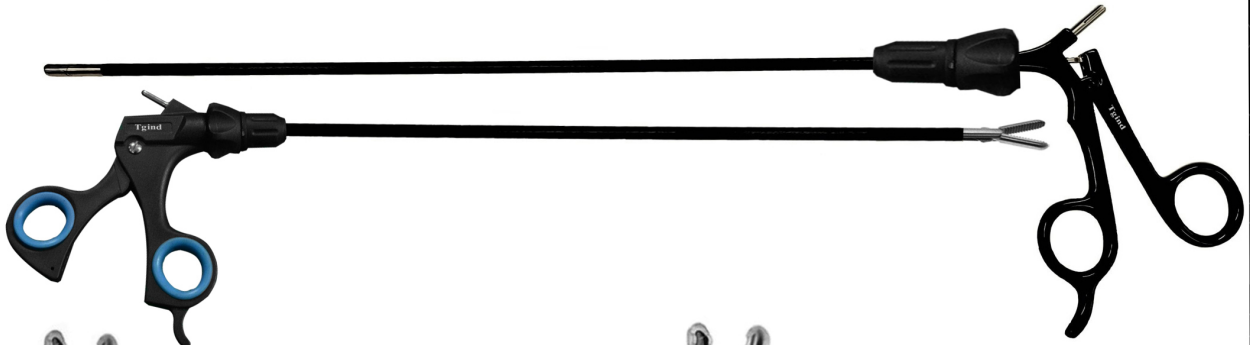

Size:	5MM Ø, WAVE GRASPER, LONG BEVELED EDGE JAW, SINGLE ACTION	
33cm	TG-REF:1106	TG-REF:1110
36cm	TG-REF:1107	TG-REF:1111
45cm	TG-REF:1108	TG-REF:1112
24cm	TG-REF:1109	TG-REF:1113



Size:	5MM Ø, WAVE GRASPER, LONG BEVELED EDGE JAW, DBL-ACTION	
33cm	TG-REF:1122	TG-REF:1126
36cm	TG-REF:1123	TG-REF:1127
45cm	TG-REF:1124	TG-REF:1128
24cm	TG-REF:1125	TG-REF:1129



Size:	5MM Ø, CLAW GRASPER, 2 X 3 TEETH, W/ EXTRA ROW OF TEETH, DOUBLE-ACTION	
33cm	TG-REF:1114	TG-REF:1118
36cm	TG-REF:1115	TG-REF:1119
45cm	TG-REF:1116	TG-REF:1120
24cm	TG-REF:1117	TG-REF:1121



Size:	5MM Ø, CLAW GRASPER, 2 X 3 TEETH, SINGLE-ACTION	
33cm	TG-REF:1129	TG-REF:1133
36cm	TG-REF:1130	TG-REF:1134
45cm	TG-REF:1131	TG-REF:1135
24cm	TG-REF:1132	TG-REF:1136



Size:	5MM Ø, RETRACTION GRASPER, LONG RIDGED JAWS, 2 X 3 ATRAUMATIC TEETH, SINGLE-ACTION	
33cm	TG-REF:1112	TG-REF:1116
36cm	TG-REF:1113	TG-REF:1117
45cm	TG-REF:1114	TG-REF:1118
24cm	TG-REF:1115	TG-REF:1119



Size:	5MM Ø, RETRACTION GRASPER, LONG RIDGED JAWS, 2X3 ATRAUMATIC TEETH, DOUBLE-ACTION	
33cm	TG-REF:1137	TG-REF:1141
36cm	TG-REF:1138	TG-REF:1142
45cm	TG-REF:1139	TG-REF:1143
24cm	TG-REF:1140	TG-REF:1144

Style A:

Style B:

Style C:



Type 3:
Non-Insulated
Ratchet /
Ratchet Defeating

Type 2:
Non-Insulated
Stainless Steel

Type 1:
Insulated Stainless
Steel w/ RF Post

Size:	5MM Ø, RETRACTION GRASPER, 2 X 3 ATRAUMATIC TEETH, DOUBLE-ACTION (JARIT STYLE)	
33cm	TG-REF:1145	TG-REF:1149
36cm	TG-REF:1146	TG-REF:1150
45cm	TG-REF:1147	TG-REF:1151
24cm	TG-REF:1148	TG-REF:1152

Laparoscopic Grasper & Dissector With Handle

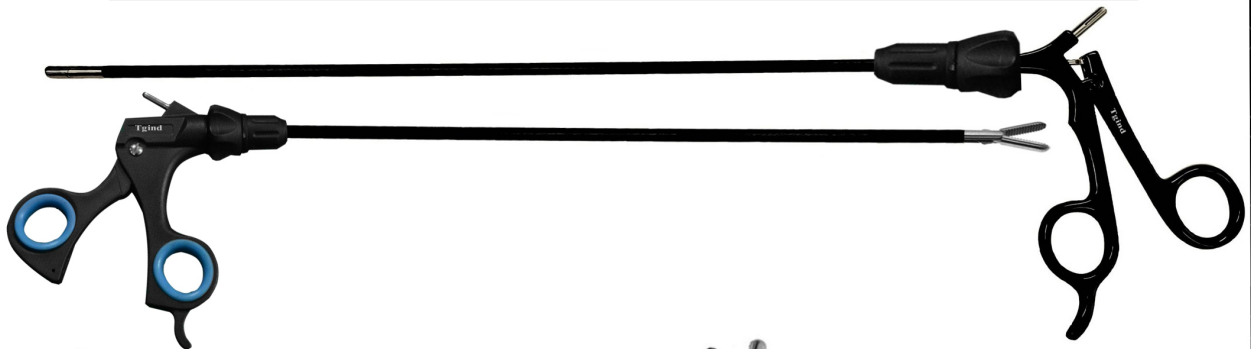

Size:	5MM Ø, JOHAN FENESTRATED GRASPER, 22 MM SINGLE-ACTION FLAT JAWS	
33cm	TG-RFF:1153	TG-RFF:1157
36cm	TG-RFF:1154	TG-RFF:1158
45cm	TG-RFF:1155	TG-RFF:1159
24cm	TG-RFF:1156	TG-RFF:1160



Size:	5MM Ø, FENESTRATED GRASPER, 40 MM DBL-ACTION JAW	
33cm	TG-RFF:1177	TG-RFF:1181
36cm	TG-RFF:1178	TG-RFF:1182
45cm	TG-RFF:1179	TG-RFF:1183
24cm	TG-RFF:1180	TG-RFF:1184



Size:	5MM Ø, KOCHER GRASPER, 1 X 2 TEETH, SINGLE-ACTION FLAT JAWS	
33cm	TG-RFF:1161	TG-RFF:1165
36cm	TG-RFF:1162	TG-RFF:1166
45cm	TG-RFF:1163	TG-RFF:1167
24cm	TG-RFF:1164	TG-RFF:1168



Size:	5MM Ø, JOHAN FENESTRATED GRASPER, 45 MM SGL-ACTION FLAT JAWS	
33cm	TG-RFF:1185	TG-RFF:1189
36cm	TG-RFF:1186	TG-RFF:1190
45cm	TG-RFF:1187	TG-RFF:1191
24cm	TG-RFF:1188	TG-RFF:1192



Size:	5MM Ø, SCHROEDER TENACULUM GRASPER, SINGLE TEETH	
33cm	TG-RFF:1169	TG-RFF:1173
36cm	TG-RFF:1170	TG-RFF:1174
45cm	TG-RFF:1171	TG-RFF:1175
24cm	TG-RFF:1172	TG-RFF:1176



Size:	5MM Ø, KOCHER GRASPER, 1 X 2 TEETH, DOUBLE-ACTION (WECK TYPE)	
33cm	TG-RFF:1193	TG-RFF:1197
36cm	TG-RFF:1194	TG-RFF:1198
45cm	TG-RFF:1195	TG-RFF:1199
24cm	TG-RFF:1196	TG-RFF:1200

Style A:

Style B:

Style C:



Type 3:
Non-Insulated
Ratchet /
Ratchet Defeating



Type 2:
Non-Insulated
Stainless Steel



Type 1:
Insulated Stainless
Steel w/ RF Post



Size:	5MM Ø, SCHROEDER TENACULUM GRASPER, SINGLE TEETH w/ EXTRA GUIDE TOOTH	
33cm	TG-RFF:1201	TG-RFF:1205
36cm	TG-RFF:1202	TG-RFF:1206
45cm	TG-RFF:1203	TG-RFF:1207
24cm	TG-RFF:1204	TG-RFF:1208

Laparoscopic Grasper & Dissector With Handle

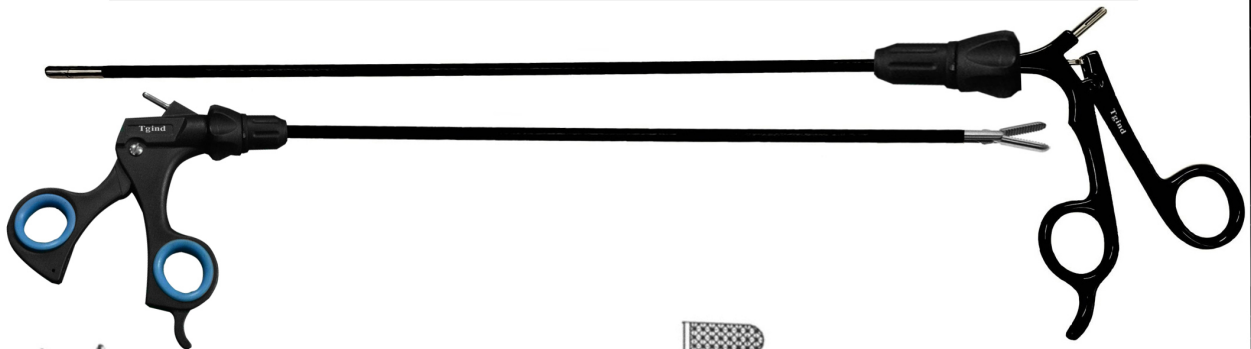

Size:	5MM Ø, LONG TAPERED GRASPER W/ ATRAUMATIC TEETH, DBL-ACTION	
33cm	TG-RFF:1209	TG-RFF:1213
36cm	TG-RFF:1210	TG-RFF:1214
45cm	TG-RFF:1211	TG-RFF:1215
24cm	TG-RFF:1212	TG-RFF:1216



Size:	5MM Ø, BULLET NOSE GRASPER /DISSECTOR, TG, CROSS DIAMOND JAW PATTERN DOUBLE-ACTION	
33cm	TG-RFF:1224	TG-RFF:1228
36cm	TG-RFF:1225	TG-RFF:1229
45cm	TG-RFF:1226	TG-RFF:1230
24cm	TG-RFF:1227	TG-RFF:1231



Size:	5MM Ø, WAVE GRASPER, BLUNT, SINGLE-ACTION	
33cm	TG-RFF:1217	TG-RFF:1221
36cm	TG-RFF:1218	TG-RFF:1222
45cm	TG-RFF:1219	TG-RFF:1223
24cm	TG-RFF:1220	TG-RFF:1224



Size:	5MM Ø, WAVE GRASPER, POINTED, SINGLE-ACTION	
33cm	TG-RFF:1232	TG-RFF:1236
36cm	TG-RFF:1233	TG-RFF:1237
45cm	TG-RFF:1234	TG-RFF:1238
24cm	TG-RFF:1235	TG-RFF:1239



Size:	5MM Ø, "ACCESS" TYPE, FENESTRATED GRASPER, 20MM JAW W/ AGGRESSIVE TEETH	
33cm	TG-RFF:1169	TG-RFF:1173
36cm	TG-RFF:1170	TG-RFF:1174
45cm	TG-RFF:1171	TG-RFF:1175
24cm	TG-RFF:1172	TG-RFF:1176



Size:	5MM Ø, "DAVOL" TYPE, ATRAUMATIC GRASPER, SCOOPED-OUT JAW & GENTLY MASHING TEETH	
33cm	TG-RFF:1240	TG-RFF:1245
36cm	TG-RFF:1241	TG-RFF:1244
45cm	TG-RFF:1242	TG-RFF:1245
24cm	TG-RFF:1243	TG-RFF:1246

Style A:

Style B:

Style C:



Type 3:
Non-Insulated
Ratchet /
Ratchet Defeating

Type 2:
Non-Insulated
Stainless Steel

Type 1:
Insulated Stainless
Steel w/ RF Post

Size:	5MM Ø, "SOFT TOUCH" GRASPER, 22 MM JAW, ATRAUMATIC TELECH. INSERTS FOR THE LIGHT MINIMUM TISSUE TRAUMA TOUCH YET POSITIVE HOLDING	
33cm	TG-RFF:1247	TG-RFF:1251
36cm	TG-RFF:1248	TG-RFF:1252
45cm	TG-RFF:1249	TG-RFF:1253
24cm	TG-RFF:1250	TG-RFF:1254

Laparoscopic Grasper & Dissector With Handle

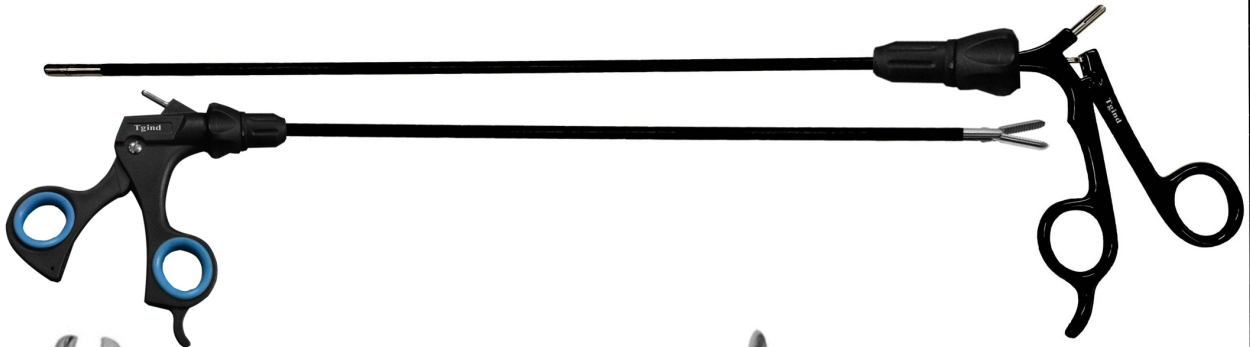

Size:	5MM Ø, HOOK SCISSORS, SINGLE-ACTION	
33cm	TG-RFF:1255	TG-RFF:1259
36cm	TG-RFF:1256	TG-RFF:1260
45cm	TG-RFF:1257	TG-RFF:1261
24cm	TG-RFF:1258	TG-RFF:1262



Size:	5MM Ø, "SOFT TOUCH" GRASPER, 40 MM JAW, ATRAUMATIC TEFロン INSERTS FOR THE LIGHT MINIMUM TISSUE TRAUMA TOUCH KEY POSITIVE HOLDING	
33cm	TG-RFF:1271	TG-RFF:1275
36cm	TG-RFF:1272	TG-RFF:1276
45cm	TG-RFF:1273	TG-RFF:1277
24cm	TG-RFF:1274	TG-RFF:1278



Size:	5MM Ø, METZENBAUM SCISSORS, STRAIGHT, LONG BLADE (20MM TIP)	
33cm	TG-RFF:1263	TG-RFF:1267
36cm	TG-RFF:1264	TG-RFF:1268
45cm	TG-RFF:1265	TG-RFF:1269
24cm	TG-RFF:1266	TG-RFF:1270



Size:	5MM Ø, MICRO TIP SCISSORS, CURVED, SINGLE-ACTION	
33cm	TG-RFF:1279	TG-RFF:1283
36cm	TG-RFF:1280	TG-RFF:1284
45cm	TG-RFF:1281	TG-RFF:1285
24cm	TG-RFF:1282	TG-RFF:1286



Size:	5MM Ø, METZENBAUM SCISSORS, CURVED, LONG BLADE (18MM TIP)	
33cm	TG-RFF:1271	TG-RFF:1273
36cm	TG-RFF:1274	TG-RFF:1275
45cm	TG-RFF:1276	TG-RFF:1277
24cm	TG-RFF:1278	TG-RFF:1279



Size:	5MM Ø, METZENBAUM SCISSORS, STRAIGHT, LONG BLADE (20MM TIP)	
33cm	TG-RFF:1287	TG-RFF:1291
36cm	TG-RFF:1288	TG-RFF:1292
45cm	TG-RFF:1289	TG-RFF:1293
24cm	TG-RFF:1290	TG-RFF:1294

Style A:

Style B:

Style C:



Type 3:
Non-Insulated
Ratchet /
Ratchet Defeating



Type 2:
Non-Insulated
Stainless Steel



Type 1:
Insulated Stainless
Steel w/ RF Post



Size:	5MM Ø, METZENBAUM SCISSORS, HARDENED STEEL, CURVED BLADE (18MM TIP)	
33cm	TG-RFF:1295	TG-RFF:1299
36cm	TG-RFF:1296	TG-RFF:1300
45cm	TG-RFF:1297	TG-RFF:1301
24cm	TG-RFF:1298	TG-RFF:1302

Laparoscopic Grasper & Dissector With Handle



Size:	5MM Ø, PERITONEAL SCISSORS, SINGLE-ACTION	
33cm	TG-RFF:1304	TG-RFF:1308
36cm	TG-RFF:1305	TG-RFF:1309
45cm	TG-RFF:1306	TG-RFF:1310
24cm	TG-RFF:1307	TG-RFF:1311



Size:	5MM Ø, METZENBAUM SCISSORS, CURVED, SHORT BLADE (11MM TIP)	
33cm	TG-RFF:1378	TG-RFF:1382
36cm	TG-RFF:1379	TG-RFF:1383
45cm	TG-RFF:1380	TG-RFF:1384
24cm	TG-RFF:1381	TG-RFF:1385



Size:	5MM Ø, PERITONEAL SCISSORS, TS, EXTRA HARD STEEL, DOUBLE-ACTION	
33cm	TG-RFF:1312	TG-RFF:1316
36cm	TG-RFF:1313	TG-RFF:1317
45cm	TG-RFF:1314	TG-RFF:1318
24cm	TG-RFF:1315	TG-RFF:1319



Size:	5MM Ø, HOOK SCISSORS, TS, EXTRA HARD STEEL	
33cm	TG-RFF:1386	TG-RFF:1390
36cm	TG-RFF:1387	TG-RFF:1391
45cm	TG-RFF:1388	TG-RFF:1392
24cm	TG-RFF:1389	TG-RFF:1393



Size:	5MM Ø, BIOPSY SPOON FORCEPS, SINGLE-ACTION	
33cm	TG-RFF:1320	TG-RFF:1374
36cm	TG-RFF:1371	TG-RFF:1375
45cm	TG-RFF:1372	TG-RFF:1376
24cm	TG-RFF:1373	TG-RFF:1377



Size:	5MM Ø, BIOPSY SPOON FORCEPS W/ TOOTH, (SEMM-TYPE) SINGLE-ACTION	
33cm	TG-RFF:1394	TG-RFF:1398
36cm	TG-RFF:1395	TG-RFF:1399
45cm	TG-RFF:1396	TG-RFF:1400
24cm	TG-RFF:1397	TG-RFF:1401

Style A:

Style B:

Style C:



Type 3:
Non-Insulated
Ratchet /
Ratchet Defeating



Type 2:
Non-Insulated
Stainless Steel



Type 1:
Insulated Stainless
Steel w/ RF Post



Size:	5MM Ø, BIOPSY SPOON FORCEPS, DOUBLE-ACTION	
33cm	TG-RFF:1402	TG-RFF:1406
36cm	TG-RFF:1403	TG-RFF:1407
45cm	TG-RFF:1404	TG-RFF:1408
24cm	TG-RFF:1405	TG-RFF:1409

Laparoscopic Grasper & Dissector With Handle



Size:	5MM Ø, BIOPSY HOOK PUNCH, SINGLE-ACTION	
33cm	TG-RFF:1410	TG-RFF:1414
36cm	TG-RFF:1411	TG-RFF:1415
45cm	TG-RFF:1412	TG-RFF:1416
24cm	TG-RFF:1413	TG-RFF:1417



Size:	5MM Ø, BIOPSY SPOON FORCEPS, W/ TOOTH (SEMM-TYPE), DBL-ACTION	
33cm	TG-RFF:1426	TG-RFF:1430
36cm	TG-RFF:1427	TG-RFF:1431
45cm	TG-RFF:1428	TG-RFF:1432
24cm	TG-RFF:1429	TG-RFF:1433



Size:	5MM Ø, BIOPSY PUNCH, SINGLE-ACTION	
33cm	TG-RFF:1418	TG-RFF:1422
36cm	TG-RFF:1419	TG-RFF:1423
45cm	TG-RFF:1420	TG-RFF:1424
24cm	TG-RFF:1421	TG-RFF:1425



Size:	5MM Ø, BIOPSY PUNCH WITH TOOTH, SINGLE-ACTION	
33cm	TG-RFF:1434	TG-RFF:1438
36cm	TG-RFF:1435	TG-RFF:1439
45cm	TG-RFF:1436	TG-RFF:1440
24cm	TG-RFF:1437	TG-RFF:1441

Style A:



Type 3:
Non-Insulated
Ratchet /
Ratchet Defeating

Style B:



Type 2:
Non-Insulated
Stainless Steel

Style C:



Type 1:
Insulated Stainless
Steel w/ RF Post

Laparoscopic Grasper & Dissector With Handle



- FEATURES:**
- SHORTER, LIGHTWEIGHT DOUBLE-ACTION AXIAL HANDLE
 - SOLID QUICK THUMB RELEASE
 - THE HANDLE GIVES THE USER THE MOST PRECISE, ERGONOMICAL HAND MANIPULATION
 - COMPLETELY REUSABLE



STRAIGHT 8MM TC TIP		
20CM SHAFT	30CM SHAFT	45CM SHAFT
TG-RFF:1442	TG-RFF:1443	TG-RFF:1444



SELF-RIGHTING NEEDLE TIP		
20CM SHAFT	30CM SHAFT	45CM SHAFT
TG-RFF:1445	TG-RFF:1446	TG-RFF:1447



CURVED RIGHT TC TIP		
20CM SHAFT	30CM SHAFT	45CM SHAFT
TG-RFF:1448	TG-RFF:1449	TG-RFF:1450



CURVED LEFT TC TIP		
20CM SHAFT	30CM SHAFT	45CM SHAFT
TG-RFF:1451	TG-RFF:1452	TG-RFF:1453

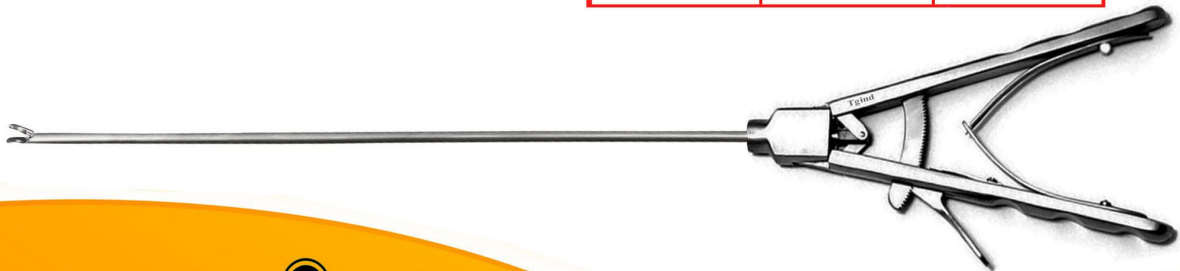

Laparoscopic Needle Holders



Needle Holder Straight 5x330mm

TG-REF:1454



Maryland Dissector 5x330mm

TG-REF:1455



Scissors Curved 5x330mm

TG-REF:1456



Johann Fenestrated Grasper 5x330mm

TG-REF:1457

Laparoscopic Clip Applicator

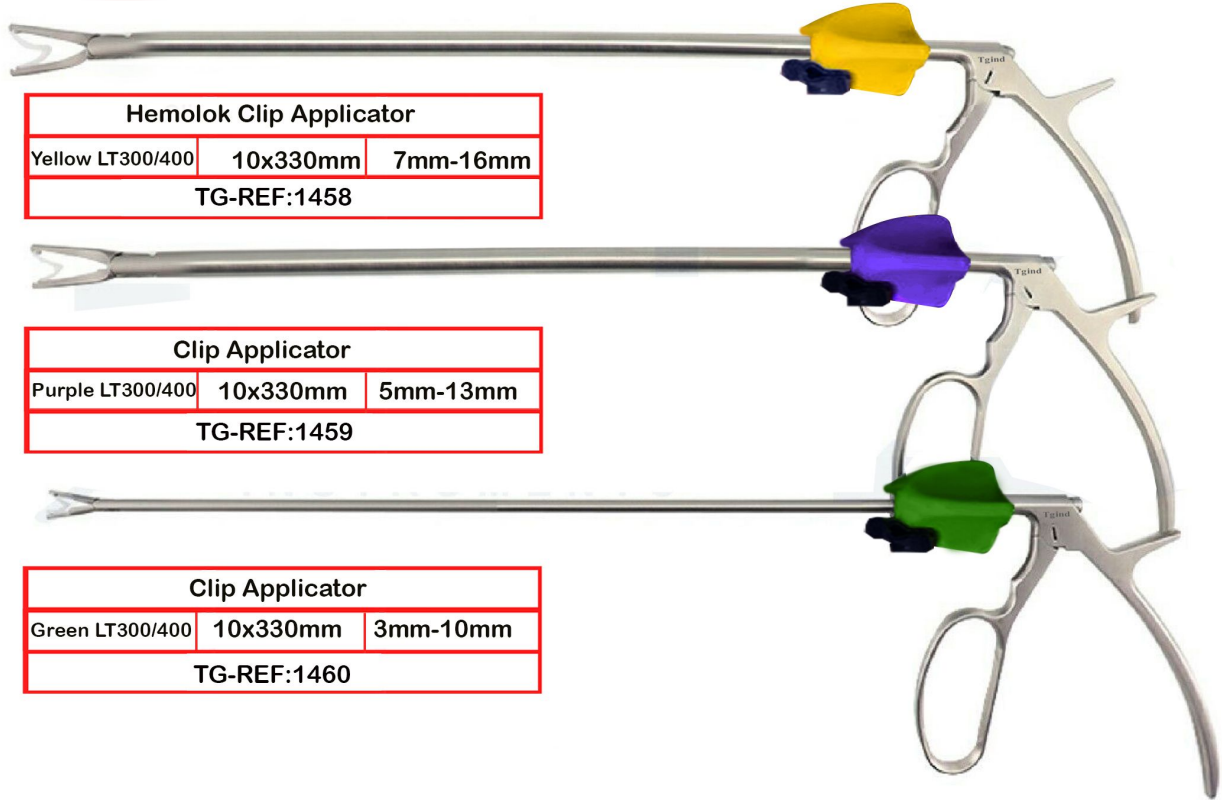

Hemolok Clip Applicator		
Yellow LT300/400	10x330mm	7mm-16mm
TG-REF:1458		

Clip Applicator		
Purple LT300/400	10x330mm	5mm-13mm
TG-REF:1459		

Clip Applicator		
Green LT300/400	10x330mm	3mm-10mm
TG-REF:1460		

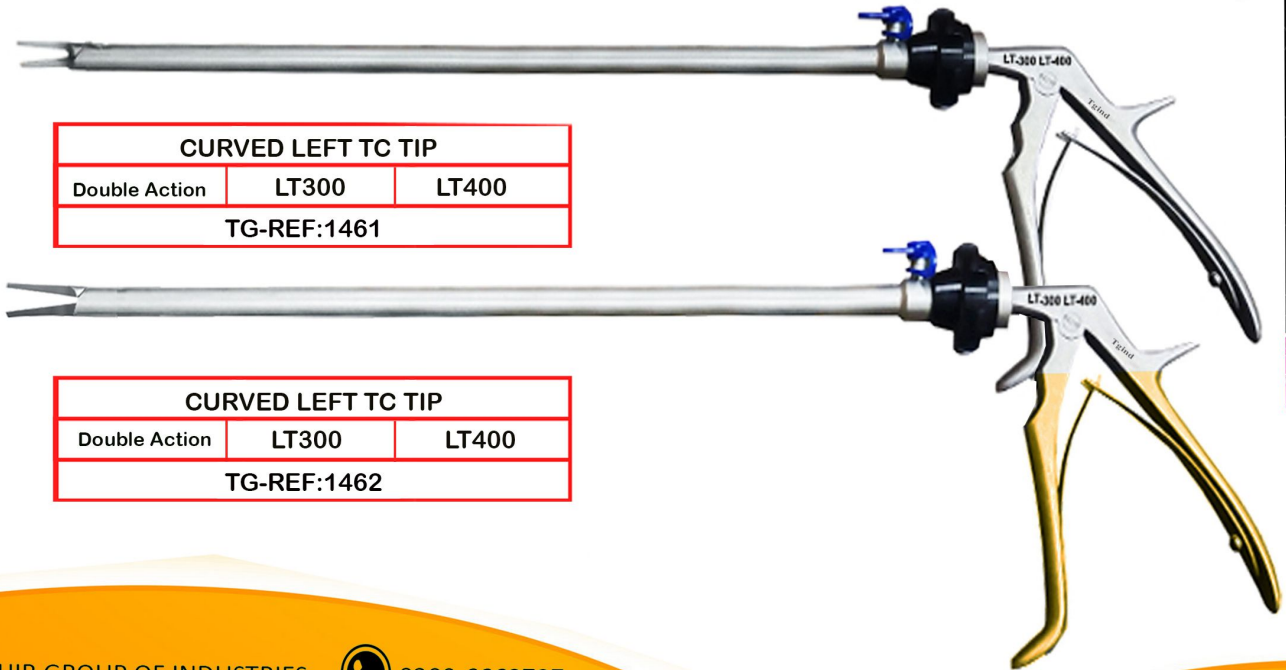

CURVED LEFT TC TIP		
Double Action	LT300	LT400
TG-REF:1461		

CURVED LEFT TC TIP		
Double Action	LT300	LT400
TG-REF:1462		

Ridge Endoscopy

EOS HD MINI LAPAROSCOPE, 0° STANDARD
EYE PIECE, 2.9MM DIA., 30CM LENGTH,
PREMIUM ROD LENS SYSTEM- AUTOCLAVABLE
TG-REF:1463

EOS HD MINI LAPAROSCOPE, 30° STANDARD
EYE PIECE, 2.9MM DIA., 30CM LENGTH,
PREMIUM ROD LENS SYSTEM- AUTOCLAVABLE
TG-REF:1464

EOS HD MINI LAPAROSCOPE, 70° STANDARD
EYE PIECE, 2.9MM DIA., 30CM LENGTH,
PREMIUM ROD LENS SYSTEM- AUTOCLAVABLE
TG-REF:1465

Laparoscopic Spiral Trocar Cannula

Laparoscopic Spiral Trocar Cannula
5mm
TG-REF:1466

Laparoscopic Spiral Trocar Cannula
10mm
TG-REF:1467

Hydatid Cyst Trocar Cannula
10mm
TG-REF:1468

STAINLESS STEEL TROCAR SLEEVES w/ TRUMPET VALVE



DIAMETER	STANDARD 110 MM	EXTRA LONG 150 MM	STANDARD 110 MM	EXTRA LONG 150 MM
2 MM Ø	TG-REF:1469	TG-REF:1470	TG-REF:1471	TG-REF:1472
3 MM Ø	TG-REF:1473	TG-REF:1474	TG-REF:1475	TG-REF:1476
5 MM Ø	TG-REF:1477	TG-REF:1478	TG-REF:1479	TG-REF:1480
6 MM Ø	TG-REF:1481	TG-REF:1482	TG-REF:1483	TG-REF:1484
7 MM Ø	TG-REF:1485	TG-REF:1486	TG-REF:1487	TG-REF:1488
8 MM Ø	TG-REF:1489	TG-REF:1490	TG-REF:1491	TG-REF:1492
10 MM Ø	TG-REF:1493	TG-REF:1494	TG-REF:1495	TG-REF:1496
11 MM Ø	TG-REF:1497	TG-REF:1498	TG-REF:1499	TG-REF:1500
12 MM Ø	TG-REF:1501	TG-REF:1502	TG-REF:1503	TG-REF:1504

STAINLESS STEEL TROCARS



DIAMETER	STANDARD	EXTRA	STANDARD	EXTRA	STANDARD	EXTRA
2 MM Ø	TG-REF:1505	TG-REF:1506	TG-REF:1507	TG-REF:1508	TG-REF:1509	TG-REF:1510
3 MM Ø	TG-REF:1511	TG-REF:1512	TG-REF:1513	TG-REF:1514	TG-REF:1515	TG-REF:1516
5 MM Ø	TG-REF:1517	TG-REF:1518	TG-REF:1519	TG-REF:1519	TG-REF:1520	TG-REF:1521
6 MM Ø	TG-REF:1522	TG-REF:1523	TG-REF:1524	TG-REF:1525	TG-REF:1526	TG-REF:1527
7 MM Ø	TG-REF:1528	TG-REF:1529	TG-REF:1530	TG-REF:1531	TG-REF:1532	TG-REF:1533
8 MM Ø	TG-REF:1534	TG-REF:1535	TG-REF:1536	TG-REF:1537	TG-REF:1538	TG-REF:1539
10 MM Ø	TG-REF:1540	TG-REF:1541	TG-REF:1542	TG-REF:1543	TG-REF:1544	TG-REF:1545
11 MM Ø	TG-REF:1546	TG-REF:1547	TG-REF:1548	TG-REF:1550	TG-REF:1551	TG-REF:1552
12 MM Ø	TG-REF:1553	TG-REF:1554	TG-REF:1555	TG-REF:1556	TG-REF:1557	TG-REF:1558

Laparoscopy Surgical Instruments

LIGHTWEIGHT MAGNA-CLOSE TROCAR SLEEVE



STANDARD
STAINLESS STEEL SLEEVE W/ REMOVABLE
SHEATH & INSUFFLATION PORT



THREADED
STAINLESS STEEL SLEEVE W/ REMOVABLE
SHEATH & INSUFFLATION PORT

DIAMETER	STANDARD 110 MM	EXTRA LONG 150 MM	STANDARD 110 MM	EXTRA LONG 150 MM
2 MM Ø	TG-REF:1559	TG-REF:1560	TG-REF:1561	TG-REF:1562
3 MM Ø	TG-REF:1558	TG-REF:1563	TG-REF:1564	TG-REF:1565
5 MM Ø	TG-REF:1558	TG-REF:1566	TG-REF:1567	TG-REF:1568
6 MM Ø	TG-REF:1558	TG-REF:1569	TG-REF:1570	TG-REF:1571
7 MM Ø	TG-REF:1558	TG-REF:1572	TG-REF:1573	TG-REF:1575
8 MM Ø	TG-REF:1558	TG-REF:1576	TG-REF:1577	TG-REF:1579
10 MM Ø	TG-REF:1558	TG-REF:1580	TG-REF:1581	TG-REF:1582
11 MM Ø	TG-REF:1558	TG-REF:1583	TG-REF:1584	TG-REF:1585
12 MM Ø	TG-REF:1558	TG-REF:1586	TG-REF:1587	TG-REF:1588

D STAINLESS STEEL SAFETY TROCARS, SPRING LOADED



DIAMETER	STANDARD	EXTRA LONG	STANDARD
2 MM Ø	TG-REF:1589	TG-REF:1590	TG-REF:1591
3 MM Ø	TG-REF:1592	TG-REF:1593	TG-REF:1594
5 MM Ø	TG-REF:1595	TG-REF:1596	TG-REF:1597
6 MM Ø	TG-REF:1598	TG-REF:1599	TG-REF:1600
7 MM Ø	TG-REF:1601	TG-REF:1602	TG-REF:1603
8 MM Ø	TG-REF:1604	TG-REF:1605	TG-REF:1606
10 MM Ø	TG-REF:1607	TG-REF:1608	TG-REF:1609
11 MM Ø	TG-REF:1610	TG-REF:1611	TG-REF:1612
12 MM Ø	TG-REF:1613	TG-REF:1614	TG-REF:1615

CANNULA, FOR OPEN LAPAROSCOPY



CLASSIC HASSON CANNULA
TRUMPET VALVE, INCLUDING TROCAR,
SLEEVE & CONE W/ SUTURE POST

CLASSIC HASSON CANNULA
TRUMPET VALVE, INCLUDING TROCAR,
SLEEVE & CONE W/ SUTURE POST

DIAMETER	STANDARD
5 MM Ø	TG-REF:1616
8 MM Ø	TG-REF:1617
10 MM Ø	TG-REF:1618
11 MM Ø	TG-REF:1619
12MM Ø	TG-REF:1620

DIAMETER	STANDARD
5 MM Ø	TG-REF:1621
8 MM Ø	TG-REF:1622
10 MM Ø	TG-REF:1623
11 MM Ø	TG-REF:1624
12MM Ø	TG-REF:1625

LAPAROSCOPY REDUCERS



DIAMETER	STANDARD REDUCER FOR FULL LENGTH OF SLEEVE
5-3 MM Ø	TG-REF:1626
12-5 MM Ø	TG-REF:1627
10-5 MM Ø	TG-REF:1628
11-5 MM Ø	TG-REF:1629
12-10 MM Ø	TG-REF:1630

DIAMETER	REDUCER WITH FLIP VALVE FOR SLEEVE TOP OPENING
5-3 MM Ø	TG-REF:1631
12-5 MM Ø	TG-REF:1632
10-5 MM Ø	TG-REF:1633
11-5 MM Ø	TG-REF:1634
12-10 MM Ø	TG-REF:1635

DILATION SETS – COMPLETE SLEEVE AND PROBE



DIAMETER	DILATION SET
5-11 MM Ø	TG-REF:1636
10-15 MM Ø	TG-REF:1637

3MM MONOPOLAR LAPAROSCOPIC ELECTRODES



SIDE MOUNTED RF CONNECTOR



Size	Knife
20C	TG-REF:1638
30C	TG-REF:1639
45C	TG-REF:1640



Size	Cone
20C	TG-REF:1641
30C	TG-REF:1642
45C	TG-REF:1643



Size	L: Hook
20C	TG-REF:1644
30C	TG-REF:1645
45C	TG-REF:1646



Size	J: Hook
20C	TG-REF:1647
30C	TG-REF:1648
45C	TG-REF:1649



Size	Spatula
20C	TG-REF:1650
30C	TG-REF:1651
45C	TG-REF:1652



Size	Ball
20C	TG-REF:1653
30C	TG-REF:1654
45C	TG-REF:1655



Size	Needle
20C	TG-REF:1656
30C	TG-REF:1657
45C	TG-REF:1658

3MM SUCTION/IRRIGATION CANNULAS



2.8MM, 20CM IRRIGATION/SUCTION SYSTEM W/ DUAL-VALVE HANDLE TG-REF:1659
2.8MM, 30CM IRRIGATION/SUCTION SYSTEM W/ DUAL-VALVE HANDLE TG-REF:1660



2.8MM, 20CM IRRIGATION/SUCTION SYSTEM W/ TWO-WAY LEVER VALVE CANNULA W/ CENTRAL & LATERAL DISTAL OPENINGS TG-REF:1661
2.8MM, 30CM IRRIGATION/SUCTION SYSTEM W/ TWO-WAY LEVER VALVE CANNULA W/ CENTRAL & LATERAL DISTAL OPENINGS TG-REF:1662

LAPAROSCOPIC FAN RETRACTORS



Fan-Retractor with rinsing channel 3 fingers 5mm X=340mm
TG-REF:1663

Fan-Retractor with rinsing channel 5 fingers 10mm X=380mm
TG-REF:1664



Fan-Retractor with rinsing channel angelable 5mm X=340mm
TG-REF:1665

Fan-Retractor rinsing channel 5 angleable 10mm X=380mm
TG-REF:1666



Fan-Retractor angelable 5mm X=340mm
TG-REF:1667

Fan-Retractor 5 angleable 10mm X=380mm
TG-REF:1668



Fan-Retractor 3mmX=350mm
TG-REF:1669

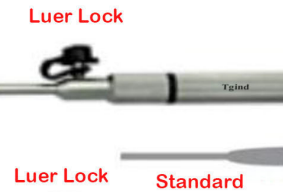

Fan-Retractor 5mmX=350mm
TG-REF:1670



Fan-Retractor 10mm X=350
TG-REF:1671



Fan-Retractor 10mm X=350
TG-REF:1672



Laparoscopy 5mm Articulating Retractors



XS
TG-REF:1674



S
TG-REF:1675



M
TG-REF:1676



M/L
TG-REF:1677



L
TG-REF:1678

5mm Laparoscopic Knot Pushers



TG-REF:1679

Martin Arm Retractor System Laparoscopic

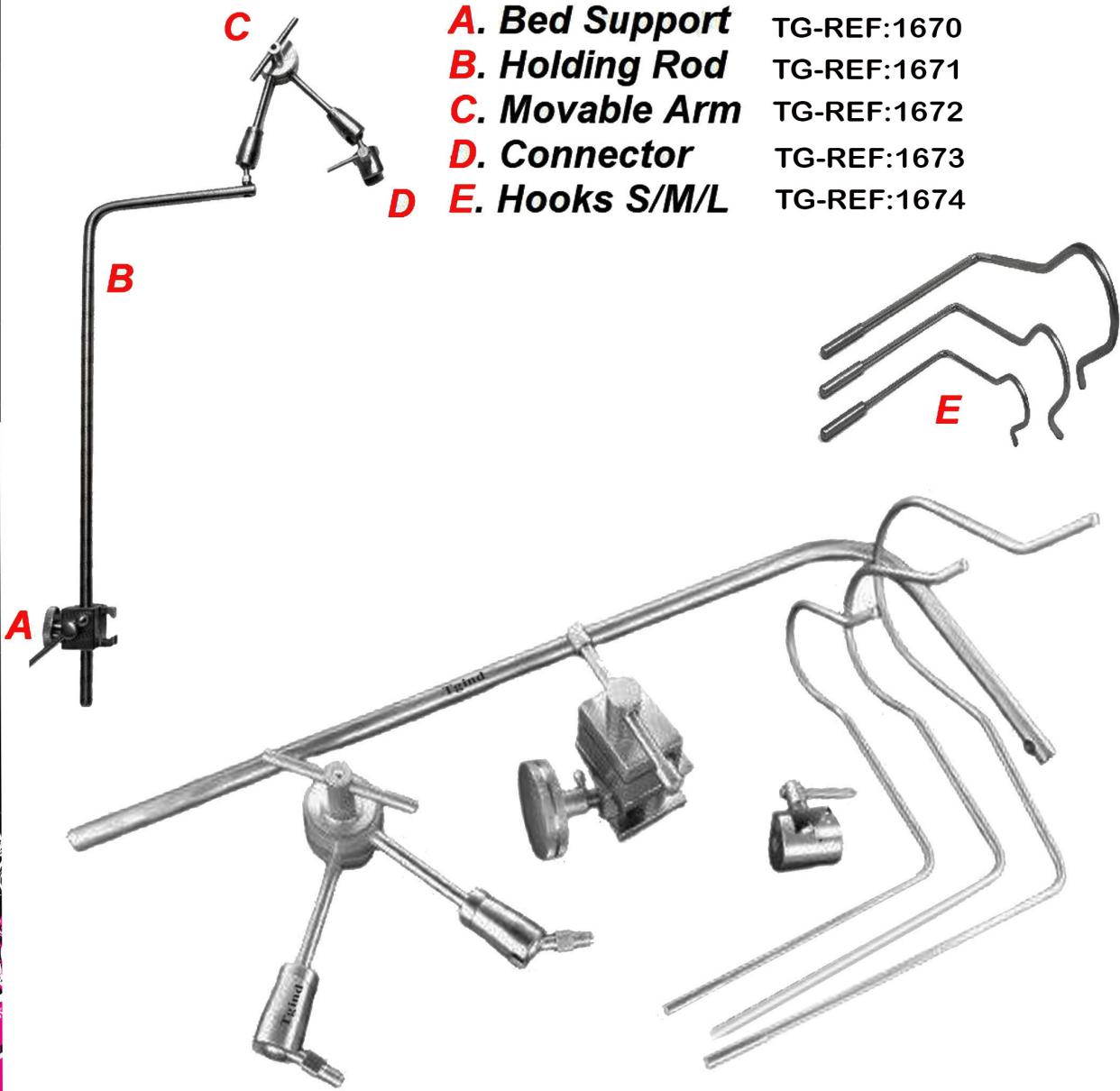

- | | |
|-----------------------|-------------|
| A. Bed Support | TG-REF:1670 |
| B. Holding Rod | TG-REF:1671 |
| C. Movable Arm | TG-REF:1672 |
| D. Connector | TG-REF:1673 |
| E. Hooks S/M/L | TG-REF:1674 |

Complete Bariatric Laparoscopy Instrument Set



- | | |
|--|---|
| <ul style="list-style-type: none"> 1) AA 10.0 mm Mixer Dissector Insert, 45 cm 1) Fascia Closure Forceps, Direction Up 1) 5.0 mm Metzenbaum, Curved Double Action Scissor Insert, 45 cm 4) 10.5 mm Laparoscopic Trocar & Cannula for Bariatrics, 120mm 6) AA 5.0 mm PEEK Carbon Laparoscopic Handle, Ratchet, 45 cm 1) 5.0 mm Dorsey Grasper Insert, 45 cm 1) 5.0 mm "L" Tip Monopolar Electrode, 45 cm 1) 5mm and 10mm Suction Irrigation Cannulas with 2 Button Push Control, 45cm 3) 5.5mm Laparoscopic Trocar & Cannula for Bariatrics, 120mm 1) 10.0 mm, Articulating 5 Blade Tip, Bariatric Retractor, 45cm 1) AA 5.0 mm PEEK Carbon Laparoscopic Handle, Non-Ratchet, 45 cm | <ul style="list-style-type: none"> 1) 5.0 mm Maryland Dissector Insert, 45 cm 1) 5.0 mm Mixer Dissector Insert, 45 cm 1) AA 10.0 mm PEEK Carbon Laparoscopic Handle, 45 cm 1) Electrosurgical Monopolar Cable with 8mm Adaptor (Valleylab/Covidien) 4) 5.0 mm Hunter Bowl Grasper Insert, 45 cm 1) 2.2mm Veress Needle, 150mm 1) 5mm Knot Pusher, Open Ended, 45cm 1) AA 5.0 mm Left Needle Holder with Inline Handle, 45 cm 1) 10mm Single Action Laparoscopic Titanium Clip Applier (M/L Clips, Compatible with Ethicon LT300, LT400), 45cm 1) 10mm to 5mm Laparoscopic Cannula Reducer, Bariatric, 170mm |
|--|---|

TG-REF:1675

Laparoscopic Instruments Set Of 28Pcs W/Case



1x Clip Applicators (10x330mm) for LT-300
 1x Needle Holder TC (5mmx330mm)
 1x Suction Irrigation System 5mm
 1x Suction Irrigation System 10mm
 1x Veress Needle
 1x Reducer
 2x Trocar 5.5mm
 2x Trocar 10.5mm
 1x Knot Pusher
 1x Claw Grasper (5mm x 330mm)
 1x Claw Grasper (10mm x 330mm)
 1x Spoon Forceps (10mm x 330mm)
 1x Hook -L Shape
 1x Spatula

1x Maryland Grasper (5mm x 330mm)
 1x Standard Grasper (5mm x 330mm)
 1x Metz Scissor - Straight (5mm x 330mm)
 1x Metz Scissor - Curved (5mm x 330mm)
 1x Fenestrated Forceps (5mm x 330mm)
 1x Clinch Fenestrated Grasper (5mm x 330mm)
 1x Babcock Grasper (5mm x 330mm)
 1x Atraumatic Grasper (5mm x 330mm)
 1x Alligator Grasper (5mm x 330mm)
 1x John Fenestrated Grasper (5mm x 330mm)
 1x Mixture Grasper (5mm x 330mm)
 1x Aspiration Needle (5mm x 330mm)

TG-REF:1676



Laparoscopic INSTRUMENTS

TGIND is Adding To It's Tradition Of Providing Quality Gynae Instruments..



Tahir Group Of Industries

Tell Off: +92-52-3257151
Fax: +92-52-3257151
Mob: +92-300-666-9737

Adress:
New Miana Pura East, Roras Road
P.O.S.I.E Sialkot 51310 Pakistan

E-Mail: info@tgind.com/
tgindsale@gmail.com
Website: www.tgind.com

